

PRICELIST 2026

A Legacy of
Trusted Partnerships



LEADING PROJECT
SUPPLIER & STOCKIST
OF ALL TYPES OF
ELECTRICAL GOODS

 **Chandan Electric Corporation**
Since 1985

Office Add. / 89, Princess Street, 2nd Flr., Peerbhoy Building, Pathak Wadi, Lohar Chawl, Mum-02.
Telephone / 022 - 2208 7580 / 3956 7492 / 4003 9101 Fax / 022 - 2201 9101
Mobile / 91 - 9820486600 / 9029895008 Website / www.chandanelectric.in
Email / chandan_electric@hotmail.co.in / info.chandanelectric@gmail.com





Power

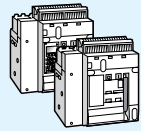

P. 23-26
DMX³ ACB from 630 A to 6300 A manual & electrical fixed + drawout version

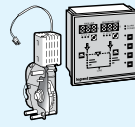

P. 28-29
Auxiliaries & accessories

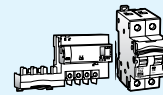

P. 32
E-communicating infrastructure

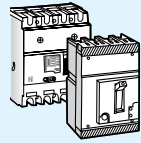

P. 48-67
DPX³ MCCBs & accessories

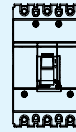

P. 70
DRX 125 MCCBs



P. 71-75 DRX 125, 250^{HP} & 630 MCCBs & accessories

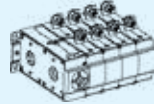

P. 82-83
DSX



P. 86-88
EMDX³ Digital meter

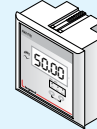

P. 90-92
PMX Digital panel meter

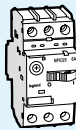

P. 102-105
MPX³ & MPX³ accessories



P. 107
Alpx³ box type capacitors standard and heavy duty 440 V

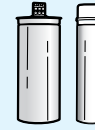

P. 107
ALPX³ resin filled capacitors standard and heavy duty 440 V, 480 V & 525 V



Protection, Isolation, Controlling, Signalling, Metering.

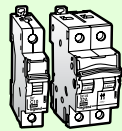

P. 112-114
DX³ MCB & isolators

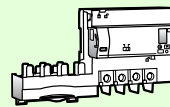

P. 116-118
DX³ RCD add-on module with metering

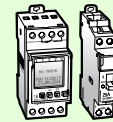

P. 119-120
DX³ time switches and contactors

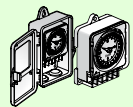

P. 119
Time switches and accessories



Distribution Boards



P. 132
Ekinox³ SPN DB



P. 132
Ekinox³ ETPN & Flexy DBs



P. 133
Ekinox³ TPN-VTPN DBs Phase selector neo DB



P. 136-137
Ekinox³ metal enclosures

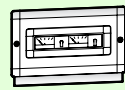

P. 137
Ekinox³ Cable end box, meter box, PPT Kit & accessories



P. 137
Ekinox³ DBs Plexo 3, boxes for DX³ and accessories



Arteor™ Advance



NEW!
P. 154-156
Push Buttons, Electric Roller Blinds, Dimmers and Fan Regulators, Indian Standard Sockets, Energy Plugs, USB Chargers, Data and Voice, TV Sockets



NEW!
P. 156-157
Classic Matt White Mechanisms, Infrared Sensors, Skirting Light, Hospitality Functions, Protector and Accessories, Audio- Video Sockets



NEW!
P. 162-163
Classic Matt Titanium Mechanisms, Hospitality Functions, Protector and Accessories, Audio- Video Sockets



NEW!
P. 163-165
Elite Matt White Mechanisms, Push Buttons, Electric Roller Blinds, Dimmers and Fan Regulators, Temperature Room Control Unit, USB Chargers, Hospitality FunctionsLight, Hospitality Functions, Protector and Accessories, Audio- Video Sockets

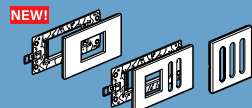

NEW!
P. 167-170
Classic Cover Plate with support frame, Elite Cover Plate with support frame, Hybrid (Classic + Elite) Cover Plate with support frame

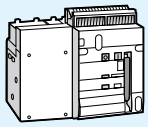

P. 34-36
DMX SP 2500 ACB
630 A to 2500 A fixed
version draw-out
version

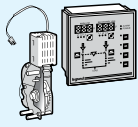

P. 37
Auxillaries &
accessories



P. 37
DMX SP 2500
protection units

NEW!

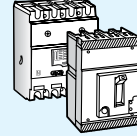

P. 42-47
DPX³ MCCBs -
125/160/250 HP

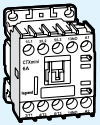

P. 94-96
CTX³ contactors

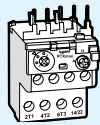

P. 97-98
RTX³
thermal relays

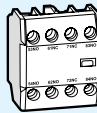

P. 99-101
CTX³ accessories



P. 107
Alpican gas filled
capacitors
heavy duty 440 V



P. 108
Reactors and power
factor controllers

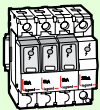

P. 123-125
SPD

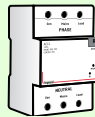

P. 127
ACCL

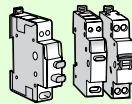

P. 127
DX3 changeover switches,
push buttons and indicators



P. 133
Ekinox³
TPN DB
7/8 segment DB



P. 134
Ekinox³
Mivan SPN,
ETPN
DB PPI DB



P. 136
Ekinox³
Phase selector Neo DB



P. 136
Ekinox³
P17 Tempra plug &
socket DBs

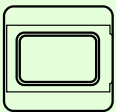

P. 138
Plexo DBs
and accessories

NEW!

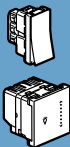

P. 157-159
Classic Matt Black Mechanisms, Push
Buttons, Electric Roller Blinds, Dimmers
and Fan Regulators, Indian Standard
Sockets, Energy Plugs, USB Chargers,
Data and Voice, TV Sockets, Skirting Lights

NEW!

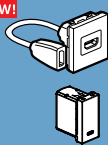

P. 159-160
Classic Matt Black
Mechanisms, Hospitality
Functions, Protector
and Accessories, Audio-
Video Sockets

NEW!



P. 160-162
Classic Matt Titanium Mechanisms,
Push Buttons, Electric Roller Blinds,
Dimmers and Fan Regulators, Indian
Standard Sockets, Energy Plugs, USB
Chargers, Data and Voice, TV Sockets

NEW!



P.165
Elite Matt Black Mechanisms, Push
Buttons, Electric Roller Blinds, Dimmers
and Fan Regulators, Temperature Room
Control Unit, USB Chargers, Hospitality
Functions

NEW!



P. 165-166
Elite Matt Titanium Mechanisms,
Push Buttons, Electric Roller Blinds,
Dimmers and Fan Regulators,
Temperature Room Control Unit,
USB Chargers, Hospitality Functions

NEW!



P.170-171
Accessories, Metal Plush Boxes &
Plastic Surface Boxes



Arteor™
Advance
IoT



NEW!

P. 180-181

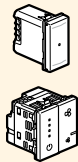

Classic Matt White & Matt Titanium Mechanism - Connected Light Switches, Outlets, Step Fan Controller, Gateway Pack, Wireless Control, Wireless Scenario Switches, IN Wall & Batteryless Switches

NEW!

P. 181-182

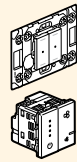

Classic Matt Black Mechanism - Connected Light Switches, Outlets, Step Fan Controller, Gateway Pack, Wireless Control, Wireless Scenario Switches, IN Wall and Batteryless Switches

NEW!

P. 185-186



Matt White, Matt Titanium, Matt Black, Frosted White and Black, Brushed Stainless Steel, Solid Aluminium and Midnight Blue Classic Cover Plates with support frame

NEW!

P. 187



Frosted White and Black, Brushed Stainless Steel, Solid Aluminium and Midnight Blue Elite Cover Plates with support frame



Arteor™

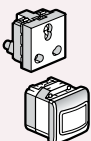

P. 202

Square white mechanism

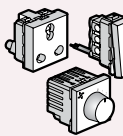

P. 202-203

Square white mechanism, USB chargers, data & voice, hotel functions, energy plugs, USB charger, RJ 11 telephone sockets, information outlets

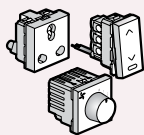

P. 206-208

Square champagne mechanism, USB chargers, data & voice, hotel functions, audio video, energy plugs, USB charger, RJ 11 telephone sockets, information outlets

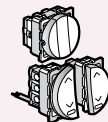

P. 208

Round white mechanisms



Arteor™
IoT

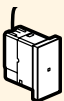

P. 224

Arteor™
connected home

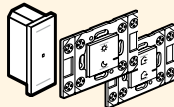

P. 224-225

White, magnesium & champagne mechanism-connected light switches, outlets, gateway pack, wireless controls & wireless scene switches



Myrius™

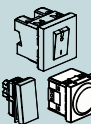
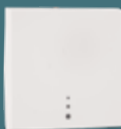

P. 234

Classic white switches, push buttons, dimmers & regulators, emergency light, sockets



P. 235-236

Hospitality functions, sockets, electronic function, USB chargers



P. 238-240

Plate with frame
White, ice white, ice black, pearl champagne, sonic silver, dark fade, interlude, trinity, luminar, stellar, ice silk, ice graphite, white glass & black glass

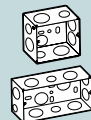

P. 240

Metal flush boxes



Myrius™
IoT



P. 244-245

Connected home white & charcoal grey mechanism, light switches, connected outlets, curtain/roller binder, gateway pack, wireless control, wireless scene switches, regulator



NEW!

P. 182

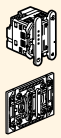

Elite Matt White Mechanism - Connected Light Switches, Outlets, Step Fan Controller, Gateway Pack, Wireless Control, Wireless Scenario Switches, IN Wall and Batteryless Switches

NEW!

P. 183



Elite Matt Titanium Mechanism - Connected Light Switches, Outlets, Step Fan Controller, Gateway Pack, Wireless Control, Wireless Scenario Switches, IN Wall and Batteryless Switches

NEW!

P. 183-184

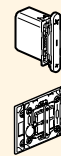

Elite Matt Black Mechanism - Connected Light Switches, Outlets, Step Fan Controller, Gateway Pack, Wireless Control, Wireless Scenario Switches, IN Wall and Batteryless Switches

NEW!

P. 188-189



Frosted Black, Brushed Stainless Steel, Solid Aluminium and Midnight Blue Hybrid (Classic +Elite) Cover Plates with support frame

NEW!

P. 189



Accessories, Metal Flush Boxes

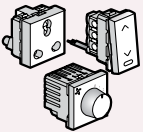

P. 204

Square magnesium mechanism, audio video

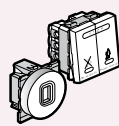

P. 204-206

Square magnesium mechanism USB chargers, data & voice, hotel functions, audio video, energy plugs, USB charger, RJ 11 telephone sockets, information outlets

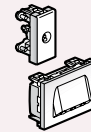

P. 206

Square champagne mechanism

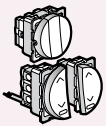

P.208-210

Round magnesium+champagne mechanism switches, push buttons, dimmers & regulators, plates,accessories

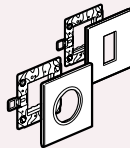

P. 211-218

Square cover plates, round cover plates

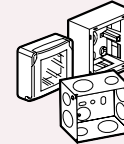

P. 218-219

Plastic surface, metal flush boxes, plexo boxes & accessories



P. 225-229

Cover plates with and without frame & accessories

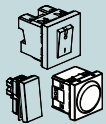

P. 236

Charcoal grey mechanisms, switches, push buttons, dimmers & regulators, emergency light, sockets



P. 237-238

Charcoal grey mechanisms, hospitality functions, electronic function, usb chagers



P. 238

Mechanism antibacterial & accessories



P. 241

Plastic surface boxes & metal surface boxes



P. 245-248

Cover frame

White, ice white, ice black, pearl champagne, sonic silver, dark fade, interlude, trinity, luminar, stellar, ice silk, ice graphite, white glass & black glass



P. 248-249

Cover plates without frame & accessories





**Myrius™
Regular**

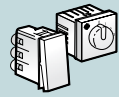

P. 250
White mechanism switches, push buttons, sockets, power units and dimmer and regulators

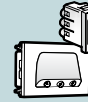

P. 251
Hospitality functions, sockets, electronic function

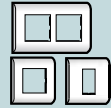

P. 253-254
White & black plastic plates

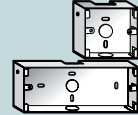

P. 254
Flush mounting & surface boxes



**Mylinc™
Wiring**

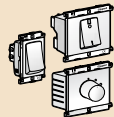

P. 258
White mechanism switches, dimmers and accessories and remote unit

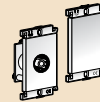

P. 258-259
White mechanism- TV and RJ 11 telephone sockets and accessories

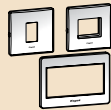

P. 260
Matt grey mechanism and USB charger

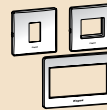

P. 261-262
Mylinc modular plates- matt grey, pearl white, champagne, silver alu, dark bronze



**Lyncus™
Wiring
Accessories**



P. 266
White mechanism switches, push buttons, standard sockets

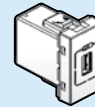

P. 267
USB chargers

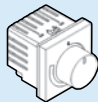

P. 268
Chic grey mechanism-switches, push buttons, dimmer and regulators, accessories



P.268
Hospitality functions, data voice, pre terminated



**Allzy
Wiring
Accessories**

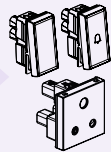

P. 278
White mechanisms - switches, sockets & dimmer and fan regulators

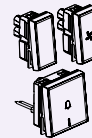

P. 278-279
White mechanisms - hospitality functions, sockets & connectors and protectors and accessories



**Britzy™
Wiring
Accessories**

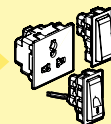

P. 284
Switches, sockets and push buttons

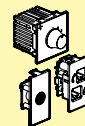

P. 284-285
Data & voice, television sockets, dimmers & regulators & accessories



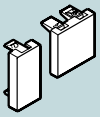

P. 251-252
Anti-Bacterial switches
and accessories

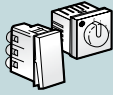

P. 252-253
Black mechanism-switches,
push buttons, sockets, power
units and dimmer and regulators

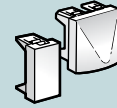

P. 253
Hospitality functions, sockets,
electronic function



P. 259
Mylinec
white modular plates

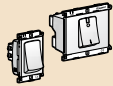

P. 259
Matt grey mechanism

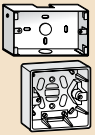

P. 262
Mylinec white
surrounds, flush, plastic and
surface boxes

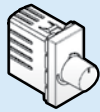

P.266-267
Dimmer and
regulators,
hospitality functions

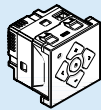

P.267-268
Sound diffusion
and loud speakers, universal
dimmers, touch switches, reading
lights

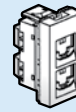

P.267
Data voice,
pre terminated audio video
connectors



P. 269
Audio video
connectors, USB
chargers



P. 269-272
Plate & frame
white, chic grey, brushed
silver, alu sunset,
champagne, matt silver

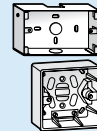

P. 272
Metal flush box &
plastic surface
boxes

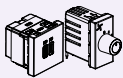

P. 279
White mechanisms -
electronic functions

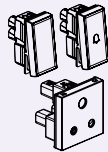

P. 279-280
Matt black mechanisms- switches, sockets
& dimmer and fan regulators, electronic
duntions, hospitality functions, sockets &
connectors and protectors and accessories

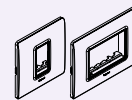

P. 280-281
Plate, frame,
boxes, flush
metal box and
surface box

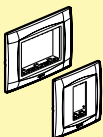

P. 285
White plate, warm orange silver,
herb beige, urban bronze,
orange chrome with frame

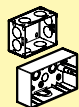

P. 285
Flush & surface
mounting boxes



Cable Management System and Accessories

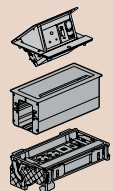

P. 299
Incara Pop-up,
Top Access,
Flip-up



NEW!
P. 301
Desktop Power
Center



NEW!
P. 303
Disq 60 & 80



P. 316-317
Selection chart:
Snap-on trunking



P. 318-319
Selection chart:
DLP PVC
adaptable trunking
system



P. 320-321
Selection chart :
DLP aluminium
Trunking system

VDI Structured Cabling

P. 331
LCS³,
Basic PDU

P. 331-332
Linkeo DC
PDU & Power cords

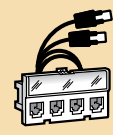

P. 332
LCS³,
cat. 6



P. 333-336
LCS³,
cat. 6A patch
panels, RJ 45,
cables and cords

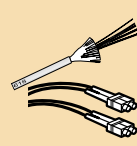

P. 341
LCS³,
audio/video patch
panel chord
cables

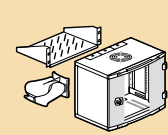

P. 342-343
Modular panels
cassettes for LCS³
fibre optic drawers

P. 343
LCS³ pigtailed,
case and
quick-connect
connectors

Movement Detectors and Door Phones

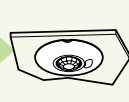

P. 349
Movement
detectors

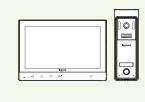

P. 349
Video door entry
system

P17 Tempra Pro, Hypra and Plugs & Sockets



P. 354
P17 Tempra Pro
sockets

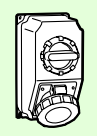

P. 354-355
P17 Tempra Pro for refrigerated container





P. 305
Pop-up box
- floor

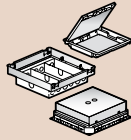

P. 309-311
Floor Solution



P. 312-313
Selection chart:
concrete floor

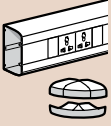

P. 322
DLP snap-on trunking
45 mm, routing
sections and
accessories

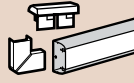

P. 323
DLP PVC trunking
system, trunking,
mini-trunking and
accessories

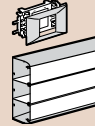

P. 324
DLP-S
PVC trunking
system and trunking
accessories

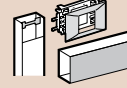

P. 324-325
DLP aluminium
adaptable trunking
system, aluminium
snap-on columns

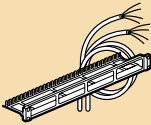

P. 337-338
LCS³,
cat. 5E patch
panels, cables
and cords, RJ 45

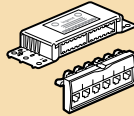

P. 338-339
LCS³,
cat. Splitter sockets, adapters
and accessories

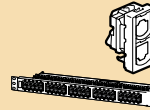

P. 339-341
LCS³, audio/video
preterminated
sockets

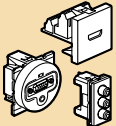

P. 343-344
9" fibre optic drawers,
LCS³ fibre optic blocks

P. 344-345
Patch chords



P. 356
Hypra industrial plugs and sockets



Smart Innovation: Around The World

Legrand Group is a global specialist in electrical and digital building infrastructure, offering smart solutions across the residential, commercial, hospitality, and industrial sectors. This strong capability has positioned Legrand as the preferred choice of discerning customers in nearly 180 countries worldwide.

Our purpose is to improve lives by transforming the spaces where people live, work and meet by delivering electrical and digital infrastructures and connected solutions that are simple, innovative and sustainable.

Guided by its philosophy of “Listen, Design, Make, and Support”, Legrand closely tracks evolving lifestyles and customer needs. The Group designs high value-added products that seamlessly integrate advanced technology, ergonomic excellence, and refined aesthetics. Through smart ideas, sleek designs, and intuitive simplicity, Legrand aims to help every customer experience a simpler, better quality of life.



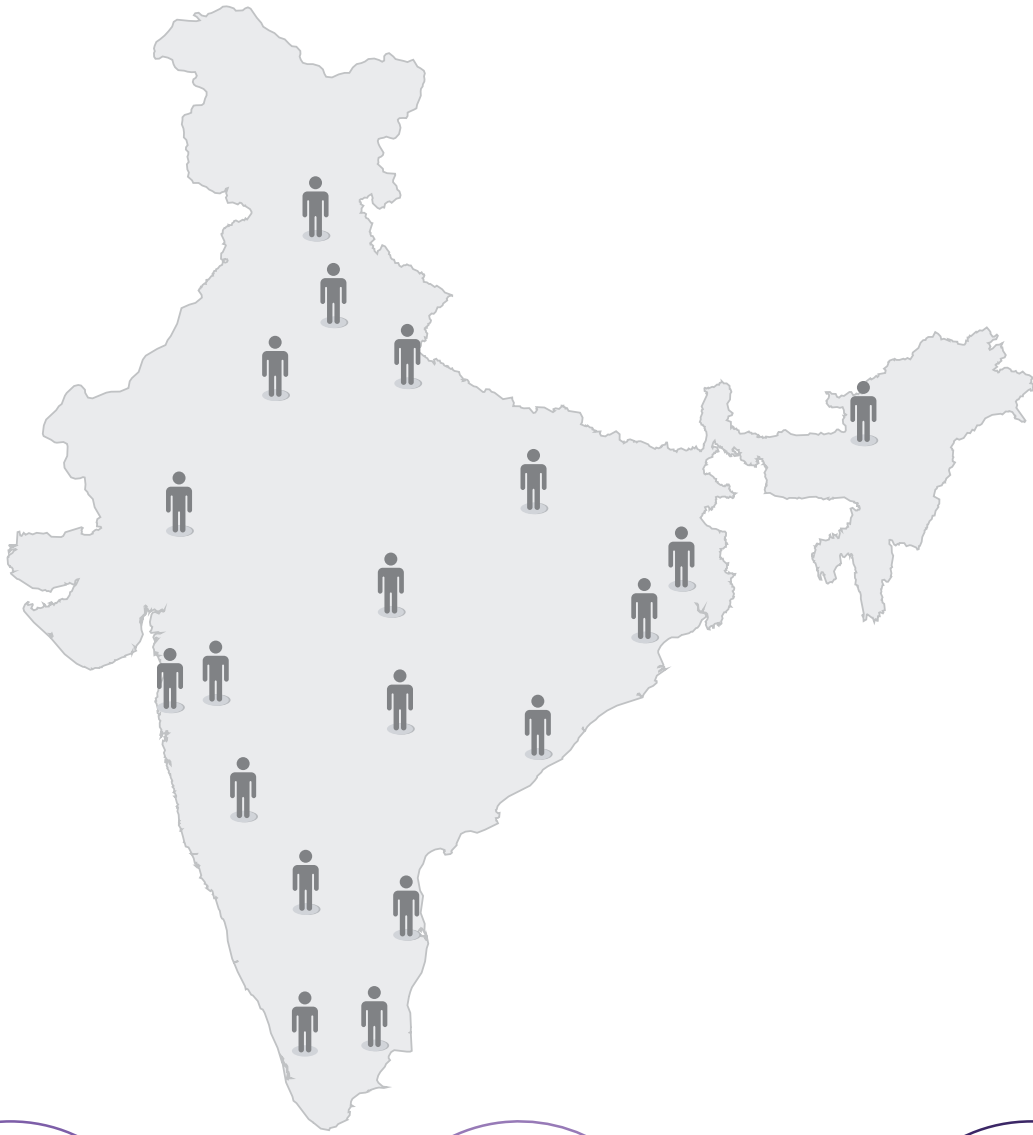

91+ OFFICES
spread across
the country

OVER 5000+
EMPLOYEES
in India

07
MANUFACTURING
facilities

3
R&D
centers

22
INNOVALS
& **3 CENTERS OF**
EXCELLENCE

An extensive network of over **870**
distribution partners and **18000** retailers

The Global Specialist

A comprehensive solution for your Electrical and Digital Building Infrastructure.

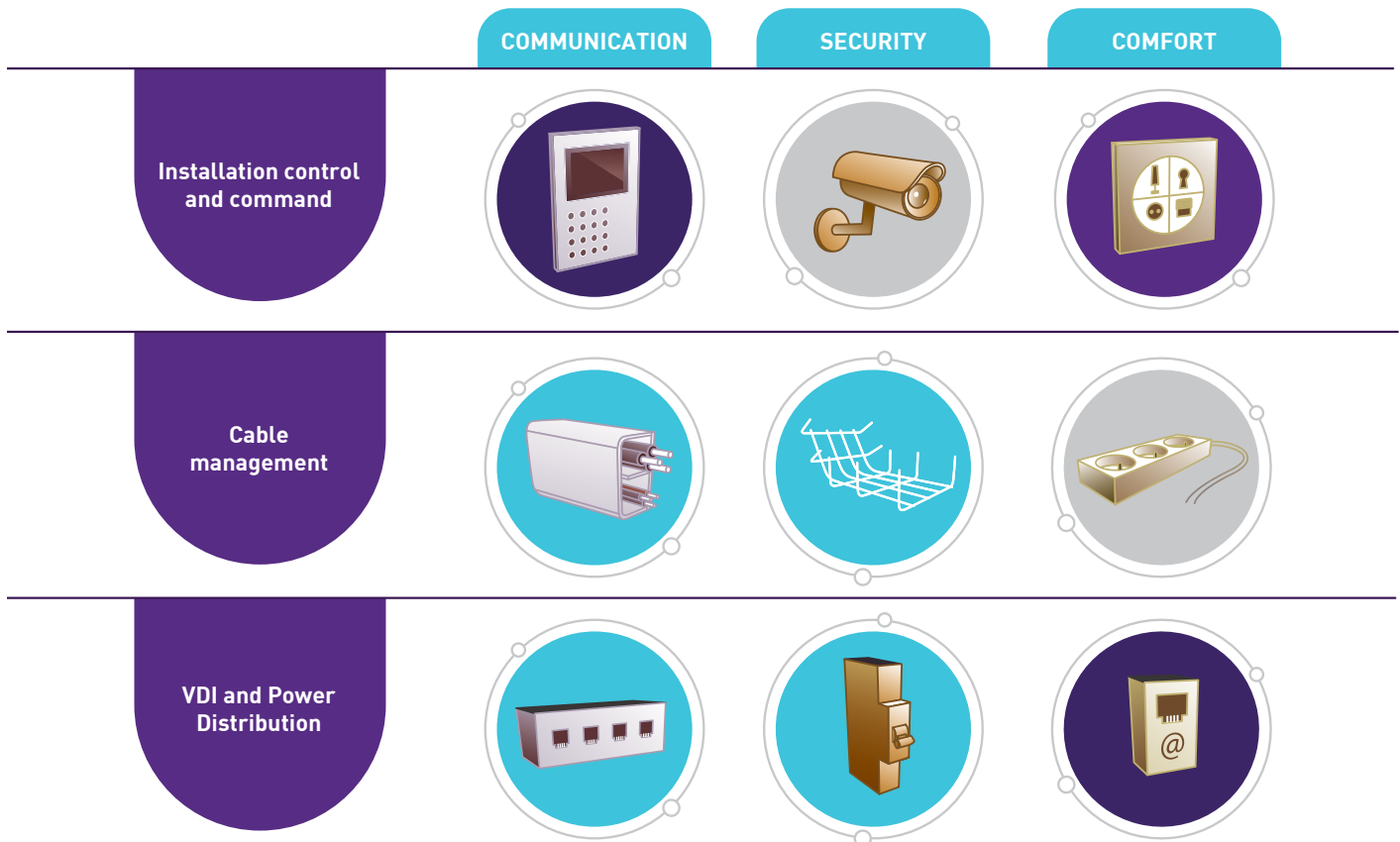

Global Specialist in Electrical and Digital Building Infrastructure

Legrand is a global specialist in electrical and digital building infrastructures, delivering solutions for homes, data centers, commercial, healthcare, hospitality, and industrial spaces. With nearly 300,000 product references, Legrand holds No. 1 or No. 2 positions in most markets worldwide.

Continuous Innovation

Over 2200 people work at our engineering and design offices, innovating simple and sustainable solutions.

Product Design – A lever for differentiation

Design is integral to our overall strategy and lies at the core of everything we do at Legrand. More than aesthetics alone, design is about enhancing the overall customer experience.

A Landmark Infrastructure Built with Purpose, Rooted in Trust



A massive infrastructure spanning 30000+ sqm, one of the largest factories for Legrand worldwide and India, was inaugurated recently at Nashik, Maharashtra. This factory assumes great significance not just for its investments and massive scale but also for its growth lever placing India at the centre of the Group's ambitions. The factory will soon be a certified green building by IGBC, with a 1 MW roof top solar installation and has been thoughtfully designed, keeping sustainability at the core of its planning.

PRODUCTS:

Our new Nashik factory is designed to manufacture Bus Bar Trunking Systems (BBTS), Distribution Boards (DBs), Server Racks, Cablofil and Industrial plugs and sockets. The factory is all set to supply products both to the local market and for export, with shipments of BBTs and industrial plug and sockets already reaching international destinations. Plans are in place to expand exports to include DBs and Cablofil products, positioning our India factory as a global supply hub with significant capacity and agility.



Our Values to Improve Lives



WE SEIZE THE FUTURE

We seize the future by creating lasting, high performance solutions for every kind of building, driven by the vision and talent of our teams



WE EMBRACE INCLUSION

We embrace inclusion by welcoming diversity among our customers, our people, and our partners, and turning it into a strength and opportunity



WE MOVE IN SYNC

We grow stronger together - collaborating with people, brands, and partners to shape a connected and future-ready electrical ecosystem



WE STRIVE FOR SIMPLICITY

We turn challenges into opportunities, creating purposeful innovations that deliver real value across every corner of the electrical sector



WE ARE DEPENDABLE

We are dependable, guided by reliability and sustainability. For over 150 years, we've built trust through responsible design and ethical relationships with our customers

Our Commitment to Sustainability



At Legrand, sustainability is a key consideration in our product development process.

Every product is crafted with a "**Eco Design**" approach, blending innovation with eco-friendly practices right from the start.

Our Product Environmental Profile (PEP) offers clear and reliable insights into the environmental impact of our products. By supporting green building initiatives and promoting eco-conscious choices, we ensure every product plays a role in building a more sustainable future.



A Landmark Infrastructure Built with Purpose, Rooted in Trust

Community Initiatives

Legrand Empowering Scholarship

Program Started in 2018, this initiative supports meritorious girl students from lower socio-economic backgrounds in Engineering, Architecture, Science, and Technology. To date, over 700+ students have been enrolled, including 66 differently abled and 25 LGBTQ+ students.

Annually, more than 100 new scholarships are awarded. Additionally, each year over 50 students receive mentorship assistance from Legrand Subject Matter Experts, till date over 150 students have been mentored to be the Future Women Leaders.



Legrand Telemedicine Center

Through our 3 centres located in Jalgaon, Haridwar, and Rohad, we offer free consultations, tests, and medicines in partnership with Apollo Hospitals. This initiative benefits over 10,000 community members annually and has positively impacted more than 72000 lives to date.

Center of Excellence - Mathura, Dehradun & Bangalore

The centers at Mathura, ITI Niranjanpur, Dehradun & Bangalore aim to provide advanced training in Electrical & UPS systems. These centers focus on enhancing students' skills and improving their job opportunities. Over 168 ITI students have been trained and over 10 have been placed as service engineers in our company.



Beach Clean-Up

Legrand adopted four beaches in Mumbai. This initiative aims to remove plastic waste and recycle it. Since September 2023, through the collective efforts of over 13992 volunteers, more than 134676 kg / 134.6 T of plastic has been collected and recycled into ten benches which were further donated to public spaces and schools.



Water Table Recharge

Legrand has recharged over 100 community borewells in rural and tribal areas using a patented technology that recharges 15–20 lakh litres of groundwater annually, directly providing clean water access to more than 5,000 individuals.



Intelligent EI

SMARTNESS THAT
MAKES A DIFFERENCE

- Advanced Protection Intelligence
- Real-time Monitoring & Metering
- Event & Fault Data Logging
- Communication Ready
- User Access Control (Password Protection)

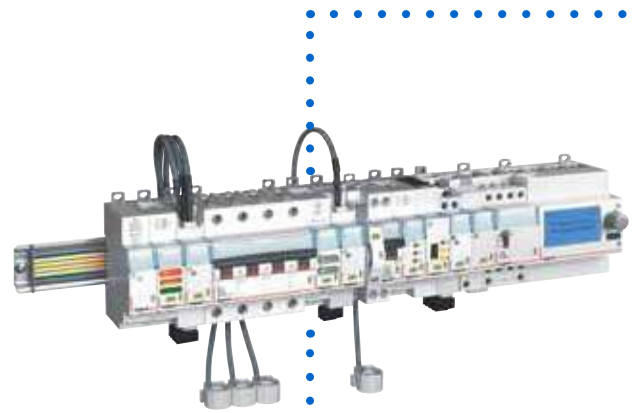

**PROGRAMMING
AND DISPLAY**



COMMUNICATION



MEASUREMENT



SIGNALLING



CONTROL



Scan to know more about
the product.



**SIGNALLING
AND CONTROL**



CX³

A Smart Platform For Your Energy Management Needs

- Smart & Connected Ready
- Compact & Modular Design
- Versatile Load Control



WEB SERVER



ACBs



MCCB'S



**MEASURING
UNIT**



WATER



GAS



Scan to know more about the product.



BMS/SCADA

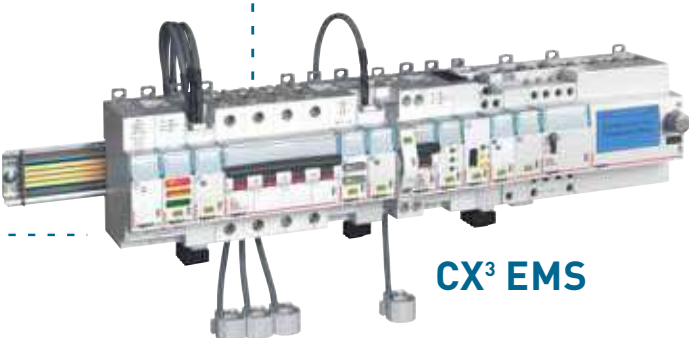

CX³ EMS



**ENERGY
METER**



ELECTRICITY

DMX³

Air Circuit Breakers

Smarter Protection for Critical Power Systems



Scan to know more about the product.



DMX³ Air Circuit Breakers

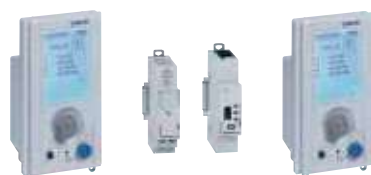

- Range – 630 A to 6300 A
- Three Optimum Frame Sizes
- Breaking Capacities of 50 kA, 65 kA & 100 kA
- Advanced Self Powered Electronic Protection Units
- MP4.10 and MP4.10M LCD Protection Units
- Long time delay protection against overloads I_r from 0.2 to 1 x I_n with (Steps 1A) - OFF
- Long delay protection operation time t_r = 40 ms + 30 s (step 40)
- Short time delay protection against short-circuits I_{sd} from 1,5I_r to 10 I_r with - OFF (step 1A)
- Short time delay protection operation time (t=k, I₂t=k) t_{sd} = 40 ms + 1 s (steps 40 ms)
- Instantaneous protection against very high short-circuits I_i from 2 to 15 I_n - OFF (step 1A)
- Earth fault current I_g from 0.2 + 1 I_n - OFF (step 0.1I_n)
- Time delay on earth fault tripping (t=k, I₂t=k) t_g from 80 ms + 1s with (step 40 ms)
- Neutral protection I_N = 50% - 100% - 150% - 200% - OFF
- Communication Capable
- In Built Temperature Protection
- Rotatable Terminals for Horizontal/Vertical Orientation^(*)
- Fast Operation
- Options to install various safety interlock
- Internal Battery for Trip Units
- Individual fault diagnosis
- Individual Fault Counter & Historical Trip Record
- Option to Measure Current, Voltage, Frequency, Power, Energy, Individual Harmonics, THD, Power Factor and internal battery voltage
- Switchable Thermal Memory

DMX ³	1	08	N	4	E	D	4N
↓	↓	↓	↓	↓	↓	↓	↓
CB Series	Frame	Rating	BC	No. of Poles	Type of Spring Charging	Type of Mechanism	Type of Release
DMX3= DMX ³	1=DMX ³ 2500 2=DMX ³ 4000	06=630A 08=800A 10=1000A 12=1250A 16=1600A 20=2000A 25=2500A 32=3200A 40=4000A	N=50kA H=65kA L=100kA	3=3Pole 4=4Pole	M=Manual Type E=Electrical with 240V AC ECD+CC & 240V AC S/T	F=Fixed D=Drawout	00=Trip Free 4N=MP4.10 LSIG 4M=MP4.10 LSIG with Measurement

Type and frame size	Rated Current (A)	3P			4P		
		Cat.Nos	MRP*/₹/Unit	Pack	Cat.Nos	MRP*/₹/Unit	Pack

Manual Fixed Version With MP4.10 PU

DMX ³ - N 2500, Icu 50 kA Frame - 1	630 A	DMX3106N3MF4N	■	1	DMX3106N4MF4N	■	1
	800 A	DMX3108N3MF4N	■	1	DMX3108N4MF4N	■	1
	1000 A	DMX3110N3MF4N	■	1	DMX3110N4MF4N	■	1
	1250 A	DMX3112N3MF4N	■	1	DMX3112N4MF4N	■	1
	1600 A	DMX3116N3MF4N	■	1	DMX3116N4MF4N	■	1
	2000 A	DMX3120N3MF4N	■	1	DMX3120N4MF4N	■	1
	2500 A	DMX3125N3MF4N	■	1	DMX3125N4MF4N	■	1
DMX ³ -N 4000 Icu 50 kA Frame - 2	3200 A	DMX3232N3MF4N	■	1	DMX3232N4MF4N	■	1
	4000 A	DMX3240N3MF4N	■	1	DMX3240N4MF4N	■	1
DMX ³ - H 2500, Icu 65 kA Frame - 1	630 A	DMX3106H3MF4N	■	1	DMX3106H4MF4N	■	1
	800 A	DMX3108H3MF4N	■	1	DMX3108H4MF4N	■	1
	1000 A	DMX3110H3MF4N	■	1	DMX3110H4MF4N	■	1
	1250 A	DMX3112H3MF4N	■	1	DMX3112H4MF4N	■	1
	1600 A	DMX3116H3MF4N	■	1	DMX3116H4MF4N	■	1
	2000 A	DMX3120H3MF4N	■	1	DMX3120H4MF4N	■	1
2500 A	DMX3125H3MF4N	■	1	DMX3125H4MF4N	■	1	



DMX3240L4MF4N

■ Price available on request.

* MRP - Maximum Retail Price Inclusive of all taxes including GST.

^(*)Built in bothside rotatable terminals up to 1600A as a standard offer.

Bold Cat.Nos are products normally available with Legrand (India) Stockists. Cat.Nos that are not bold - delivery within 4 - 8 weeks from the date of order. Bold packing quantity is our mandatory packing. Orders to be placed by Legrand (India) Stockist in multiples of the same.

DMX³ Air Circuit Breakers

Type and frame size	Rated Current (A)	3P			4P		
		Cat.Nos	MRP*/₹/Unit	Pack	Cat.Nos	MRP*/₹/Unit	Pack
Manual Fixed Version with MP4.10 PU							
DMX ³ - H 4000 Icu 65KA Frame 2	3200 A	DMX3232H3MF4N	■	1	DMX3232H4MF4N	■	1
	4000 A	DMX3240H3MF4N	■	1	DMX3240H4MF4N	■	1
DMX ³ - L 2500 Icu 100KA Frame 2	630 A	DMX3206L3MF4N	■	1	DMX3206L4MF4N	■	1
	800 A	DMX3208L3MF4N	■	1	DMX3208L4MF4N	■	1
	1000 A	DMX3210L3MF4N	■	1	DMX3210L4MF4N	■	1
	1250 A	DMX3212L3MF4N	■	1	DMX3212L4MF4N	■	1
	1600 A	DMX3216L3MF4N	■	1	DMX3216L4MF4N	■	1
	2000 A	DMX3220L3MF4N	■	1	DMX3220L4MF4N	■	1
	2500 A	DMX3225L3MF4N	■	1	DMX3225L4MF4N	■	1
DMX ³ - L 4000 Icu 100KA Frame 2	3200 A	DMX3232L3MF4N	■	1	DMX3232L4MF4N	■	1
	4000 A	DMX3240L3MF4N	■	1	DMX3240L4MF4N	■	1
DMX ³ - L 6300 Icu 100KA Frame 3	5000 A	0284 80	■	1	0284 82	■	1
	6300 A	0284 81	■	1	0284 83	■	1

Manual Drawout Version with MP 4.10 PU



DMX3108N3MD4N

DMX ³ - N 2500 Icu 50KA Frame 1	630 A	DMX3106N3MD4N	■	1	DMX3106N4MD4N	■	1
	800 A	DMX3108N3MD4N	■	1	DMX3108N4MD4N	■	1
	1000 A	DMX3110N3MD4N	■	1	DMX3110N4MD4N	■	1
	1250 A	DMX3112N3MD4N	■	1	DMX3112N4MD4N	■	1
	1600 A	DMX3116N3MD4N	■	1	DMX3116N4MD4N	■	1
	2000 A	DMX3120N3MD4N	■	1	DMX3120N4MD4N	■	1
	2500 A	DMX3125N3MD4N	■	1	DMX3125N4MD4N	■	1
DMX ³ - N 4000 Icu 50KA Frame 2	3200 A	DMX3232N3MD4N	■	1	DMX3232N4MD4N	■	1
	4000 A	DMX3240N3MD4N	■	1	DMX3240N4MD4N	■	1
DMX ³ - H 2500 Icu 65KA Frame 1	630 A	DMX3106H3MD4N	■	1	DMX3106H4MD4N	■	1
	800 A	DMX3108H3MD4N	■	1	DMX3108H4MD4N	■	1
	1000 A	DMX3110H3MD4N	■	1	DMX3110H4MD4N	■	1
	1250 A	DMX3112H3MD4N	■	1	DMX3112H4MD4N	■	1
	1600 A	DMX3116H3MD4N	■	1	DMX3116H4MD4N	■	1
	2000 A	DMX3120H3MD4N	■	1	DMX3120H4MD4N	■	1
	2500 A	DMX3125H3MD4N	■	1	DMX3125H4MD4N	■	1
DMX ³ - H 4000 Icu 65KA Frame 2	3200 A	DMX3232H3MD4N	■	1	DMX3232H4MD4N	■	1
	4000 A	DMX3240H3MD4N	■	1	DMX3240H4MD4N	■	1
DMX ³ - L 2500 Icu 100KA Frame 2	630 A	DMX3206L3MD4N	■	1	DMX3206L4MD4N	■	1
	800 A	DMX3208L3MD4N	■	1	DMX3208L4MD4N	■	1
	1000 A	DMX3210L3MD4N	■	1	DMX3210L4MD4N	■	1
	1250 A	DMX3212L3MD4N	■	1	DMX3212L4MD4N	■	1
	1600 A	DMX3216L3MD4N	■	1	DMX3216L4MD4N	■	1
	2000 A	DMX3220L3MD4N	■	1	DMX3220L4MD4N	■	1
	2500 A	DMX3225L3MD4N	■	1	DMX3225L4MD4N	■	1
DMX ³ - L 4000 Icu 100KA Frame 2	3200 A	DMX3232L3MD4N	■	1	DMX3232L4MD4N	■	1
	4000 A	DMX3240L3MD4N	■	1	DMX3240L4MD4N	■	1
DMX ³ - L 6300 Icu 100KA Frame 3	5000 A	0284 85	■	1	0284 87	■	1
	6300 A	0284 86	■	1	0284 88	■	1

* MRP - Maximum Retail Price Inclusive of all taxes including GST.
■ Price available on request.

Bold Cat.Nos are products normally available with Legrand (India) Stockists.
Cat.Nos that are not bold - delivery within 4 - 8 weeks from the date of order.
Bold packing quantity is our mandatory packing. Orders to be placed by Legrand (India) Stockist in multiples of the same.

DMX³

Electronic Protection Units

Type and frame size	Rated Current (A)	3P			4P		
		Cat.Nos	MRP*/₹/Unit	Pack	Cat.Nos	MRP*/₹/Unit	Pack

Electrical Fixed Version with MP4.10 PU with 240V AC, ECD+CC & 240V AC S/T

DMX ³ - N 2500 Icu 50KA Frame 1	630 A	DMX3106N3EF4N	■	1	DMX3106N4EF4N	■	1
	800 A	DMX3108N3EF4N	■	1	DMX3108N4EF4N	■	1
	1000 A	DMX3110N3EF4N	■	1	DMX3110N4EF4N	■	1
	1250 A	DMX3112N3EF4N	■	1	DMX3112N4EF4N	■	1
	1600 A	DMX3116N3EF4N	■	1	DMX3116N4EF4N	■	1
	2000 A	DMX3120N3EF4N	■	1	DMX3120N4EF4N	■	1
	2500 A	DMX3125N3EF4N	■	1	DMX3125N4EF4N	■	1
DMX ³ - N 4000 Icu 50KA Frame 2	3200 A	DMX3232N3EF4N	■	1	DMX3232N4EF4N	■	1
	4000 A	DMX3240N3EF4N	■	1	DMX3240N4EF4N	■	1
DMX ³ - H 2500 Icu 65KA Frame 1	630 A	DMX3106H3EF4N	■	1	DMX3106H4EF4N	■	1
	800 A	DMX3108H3EF4N	■	1	DMX3108H4EF4N	■	1
	1000 A	DMX3110H3EF4N	■	1	DMX3110H4EF4N	■	1
	1250 A	DMX3112H3EF4N	■	1	DMX3112H4EF4N	■	1
	1600 A	DMX3116H3EF4N	■	1	DMX3116H4EF4N	■	1
	2000 A	DMX3120H3EF4N	■	1	DMX3120H4EF4N	■	1
	2500 A	DMX3125H3EF4N	■	1	DMX3125H4EF4N	■	1
DMX ³ - H 4000 Icu 65KA Frame 2	3200 A	DMX3232H3EF4N	■	1	DMX3232H4EF4N	■	1
	4000 A	DMX3240H3EF4N	■	1	DMX3240H4EF4N	■	1
DMX ³ - L 2500 Icu 100KA Frame 2	630 A	DMX3206L3EF4N	■	1	DMX3206L4EF4N	■	1
	800 A	DMX3208L3EF4N	■	1	DMX3208L4EF4N	■	1
	1000 A	DMX3210L3EF4N	■	1	DMX3210L4EF4N	■	1
	1250 A	DMX3212L3EF4N	■	1	DMX3212L4EF4N	■	1
	1600 A	DMX3216L3EF4N	■	1	DMX3216L4EF4N	■	1
	2000 A	DMX3220L3EF4N	■	1	DMX3220L4EF4N	■	1
	2500 A	DMX3225L3EF4N	■	1	DMX3225L4EF4N	■	1
DMX ³ - L 4000 Icu 100KA Frame 2	3200 A	DMX3232L3EF4N	■	1	DMX3232L4EF4N	■	1
	4000 A	DMX3240L3EF4N	■	1	DMX3240L4EF4N	■	1

Electrical Drawout Version with MP 4.10 PU with 240V AC, ECD+CC & 240V AC S/T

DMX ³ - N 2500 Icu 50KA Frame 1	630 A	DMX3106N3ED4N	■	1	DMX3106N4ED4N	■	1
	800 A	DMX3108N3ED4N	■	1	DMX3108N4ED4N	■	1
	1000 A	DMX3110N3ED4N	■	1	DMX3110N4ED4N	■	1
	1250 A	DMX3112N3ED4N	■	1	DMX3112N4ED4N	■	1
	1600 A	DMX3116N3ED4N	■	1	DMX3116N4ED4N	■	1
	2000 A	DMX3120N3ED4N	■	1	DMX3120N4ED4N	■	1
	2500 A	DMX3125N3ED4N	■	1	DMX3125N4ED4N	■	1
DMX ³ - N 4000 Icu 50KA Frame 2	3200 A	DMX3232N3ED4N	■	1	DMX3232N4ED4N	■	1
	4000 A	DMX3240N3ED4N	■	1	DMX3240N4ED4N	■	1



DMX3112N3ED4N

* MRP - Maximum Retail Price Inclusive of all taxes including GST.
■ Price available on request.

Bold Cat.Nos are products normally available with Legrand (India) Stockists. Cat.Nos that are not bold - delivery within 4 - 8 weeks from the date of order. Bold packing quantity is our mandatory packing. Orders to be placed by Legrand (India) Stockist in multiples of the same.

DMX³ Air Circuit Breakers

Type and frame size	Rated Current (A)	3P			4P		
		Cat.Nos	MRP*/₹/Unit	Pack	Cat.Nos	MRP*/₹/Unit	Pack

Electrical Drawout Version with MP 4.10 PU with 240V AC, ECD+CC & 240V AC S/T

DMX ³ - H 2500 Icu 65KA Frame 1	630 A	DMX3106H3ED4N	■	1	DMX3106H4ED4N	■	1
	800 A	DMX3108H3ED4N	■	1	DMX3108H4ED4N	■	1
	1000 A	DMX3110H3ED4N	■	1	DMX3110H4ED4N	■	1
	1250 A	DMX3112H3ED4N	■	1	DMX3112H4ED4N	■	1
	1600 A	DMX3116H3ED4N	■	1	DMX3116H4ED4N	■	1
	2000 A	DMX3120H3ED4N	■	1	DMX3120H4ED4N	■	1
	2500 A	DMX3125H3ED4N	■	1	DMX3125H4ED4N	■	1
DMX ³ - H 4000 Icu 65KA Frame 2	3200 A	DMX3232H3ED4N	■	1	DMX3232H4ED4N	■	1
	4000 A	DMX3240H3ED4N	■	1	DMX3240H4ED4N	■	1
DMX ³ - L 2500 Icu 100KA Frame 2	630 A	DMX3206L3ED4N	■	1	DMX3206L4ED4N	■	1
	800 A	DMX3208L3ED4N	■	1	DMX3208L4ED4N	■	1
	1000 A	DMX3210L3ED4N	■	1	DMX3210L4ED4N	■	1
	1250 A	DMX3212L3ED4N	■	1	DMX3212L4ED4N	■	1
	1600 A	DMX3216L3ED4N	■	1	DMX3216L4ED4N	■	1
	2000 A	DMX3220L3ED4N	■	1	DMX3220L4ED4N	■	1
	2500 A	DMX3225L3ED4N	■	1	DMX3225L4ED4N	■	1
DMX ³ - L 4000 Icu 100KA Frame 2	3200 A	DMX3232L3ED4N	■	1	DMX3232L4ED4N	■	1
	4000 A	DMX3240L3ED4N	■	1	DMX3240L4ED4N	■	1

Switch Disconnecter (Trip Free Switches) From 1250 To 6300A Manual Fixed Version

DMX ³ - I 2500 Frame 1	1250 A	DMX3112S3MF00	■	1	DMX3112S4MF00	■	1
	1600 A	DMX3116S3MF00	■	1	DMX3116S4MF00	■	1
	2000 A	DMX3120S3MF00	■	1	DMX3120S4MF00	■	1
	2500 A	DMX3125S3MF00	■	1	DMX3125S4MF00	■	1
DMX ³ -I 4000 Frame 2	3200 A	DMX3232S3MF00	■	1	DMX3232S4MF00	■	1
	4000 A	DMX3240S3MF00	■	1	DMX3240S4MF00	■	1
DMX ³ - L 4000 Icu 100KA Frame 2	6300 A	0282 88	■	1	0282 89	■	1

Manual Drawout Version

DMX ³ - I 2500 Frame 1	1250 A	DMX3112S3MD00	■	1	DMX3112S4MD00	■	1
	1600 A	DMX3116S3MD00	■	1	DMX3116S4MD00	■	1
	2000 A	DMX3120S3MD00	■	1	DMX3120S4MD00	■	1
	2500 A	DMX3125S3MD00	■	1	DMX3125S4MD00	■	1
DMX ³ -I 4000 Frame 2	3200 A	DMX3232S3MD00	■	1	DMX3232S4MD00	■	1
	4000 A	DMX3240S3MD00	■	1	DMX3240S4MD00	■	1
DMX ³ -I-6300 Frame 3	6300 A	0282 98	■	1	0282 99	■	1



DMX3120S3MD00

* MRP - Maximum Retail Price Inclusive of all taxes including GST.
■ Price available on request.

- Note - 1. For Voltages other than 220 - 250 V AC and DC, please order MF/MDO ACB and the required Voltage accessories
2. For Frame 3 ACB, consider Individual Internal and External Accessories as per requirement.
3. For EF and EDO versions of Switch-disconnectors, please contact Sales office.

Bold Cat.Nos are products normally available with Legrand (India) Stockists. Cat.Nos that are not bold - delivery within 4 - 8 weeks from the date of order. Bold packing quantity is our mandatory packing. Orders to be placed by Legrand (India) Stockist in multiples of the same.

DMX³ Air Circuit Breakers

Cat.Nos	Description	MRP*/₹/Unit	Pack
---------	-------------	-------------	------

Electronic Protection Units MP4.10

0283 06	MP4.10 Protection Unit with rotating encoder for Adjustment of Ir,tr,isd,tsd,li,Ig and tg Possibility to enable/disable protections With Current Measurement and LCD display protection conditions Fault signaling and log	■	1
---------	---	---	---



0283 06

Electronic Protection Units MP4.10M

0283 07	MP4.10M Protection Unit with rotating encoder for Adjustment via rotating encoder Adjustment of Ir,tr,isd,tsd,li,Ig and tg Possibility to enable/disable protections With Current, Voltage, Frequency Power, Energy Measurement, individual harmonics, THD and LCD display with instantaneous, maximum and average values of different electrical values and protection conditions Fault signaling and log	■	1
---------	---	---	---



0283 07

Type and frame size	3P			4P		
	Cat.Nos	MRP*/₹/Unit	Pack	Cat.Nos	MRP*/₹/Unit	Pack

Fixed Version

DMX ³ 2500, fixed version, frame - 1	0288 84	■	1	0288 85	■	1
	0288 82	■	1	0288 83	■	1
DMX ³ 4000, DMX ³ 6300 fixed version, frame - 2 & 3	0288 92	■	1	0288 93	■	1
DMX ³ 2500 draw-out version, Frame - 1	0288 96	■	1	0288 97	■	1
DMX ³ 4000, DMX ³ 6300 draw-out version, fram - 2 & 3	0288 94	■	1	0288 95	■	1
DMX ³ 2500, draw-out version, frame-1 suitable for Aluminium	0288 96A	■	1	0288 97A	■	1
DMX ³ 4000, DMX ³ 6300 draw-out version, frame - 2&3, suitable for Aluminium	0288 94A	■	1	0288 95A	■	1



0288 84



0288 82

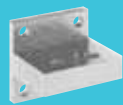

0288 96

Spreaders/Terminal Adaptors

DMX ³ 2500, fixed version, frame - 1	0289 02	■	1	0288 87	■	1
	0288 88	■	1	0288 89	■	1
	0288 90	■	1	0288 91	■	1



0288 91

Equipment For Conversion Of A Fixed Device Into Draw-Out Device

Bases (Cradle) For Draw-Out Device

DMX ³ /DMX ³ -I 2500, frame - 1	0289 02	■	1	0289 03	■	1
---	---------	---	---	---------	---	---

* MRP - Maximum Retail Price Inclusive of all taxes including GST.

■ Price available on request.

Red Cat. Nos - New Products

For External Neutral Sensors for DMX3 ACB, please contact sales office.

Bold Cat.Nos are products normally available with Legrand (India) Stockists. Cat.Nos that are not bold - delivery within 4 - 8 weeks from the date of order. Bold packing quantity is our mandatory packing. Orders to be placed by Legrand (India) Stockist in multiples of the same.

DMX³ Air Circuit Breakers

Equipment For Conversion Of A Fixed Device Into Draw-Out Device

Bases (Cradle) For Draw-Out Device

DMX ³ /DMX ³ -I 4000, frame - 2	0289 04	■	1	0289 05	■	1
DMX ³ /DMX ³ -I 6300, frame - 3	0289 13	■	1	0289 14	■	1

Transformation kit for Draw-Out Version

DMX ³ /DMX ³ -I 2500, frame - 1	0289 09	■	1	0289 10	■	1
DMX ³ /DMX ³ -I 4000, frame - 2	0289 11	■	1	0289 12	■	1
DMX ³ /DMX ³ -I 6300, frame - 3	0289 15	■	1	0289 16	■	1

DMX³

Auxiliaries and Accessories

Cat.Nos	Description	MRP* ₹ / Unit	Pack
---------	-------------	------------------	------

Control and Signalling Auxiliaries

Shunt Trip

0288 48	24 V \sim /=	■	1
0288 49	48 V \sim /=	■	1
0288 50	110 V \sim /=	■	1
0288 51	230 V \sim /=	■	1
0288 52	415 V \sim	■	1



0288 51

Undervoltage Releases

0288 55	24 V \sim /=	■	1
0288 56	48 V \sim /=	■	1
0288 57	110 V \sim /=	■	1
0288 58	230 V \sim /=	■	1
0288 59	415 V \sim	■	1



0288 58

DMX³

Auxiliaries and Accessories

Cat.Nos	Description	MRP* ₹ / Unit	Pack
---------	-------------	------------------	------

Undervoltage Releases With Delay

0288 62	110 V \sim /=	■	1
0288 63	230 V \sim /=	■	1

Motor Operators

0288 34	24 V \sim /=	■	1
0288 35	48 V \sim /=	■	1
0288 36	110 V \sim /=	■	1
0288 37	230 V \sim /=	■	1
0288 38	415 V \sim	■	1



0288 37

Closing Coils

0288 41	24 V \sim /=	■	1
0288 42	48 V \sim /=	■	1
0288 43	110 V \sim /=	■	1
0288 44	230 V \sim /=	■	1
0288 45	415 V \sim /=	■	1



0288 44

* MRP - Maximum Retail Price Inclusive of all taxes including GST.
■ Price available on request.

Bold Cat.Nos are products normally available with Legrand (India) Stockists. Cat.Nos that are not bold - delivery within 4 - 8 weeks from the date of order. Bold packing quantity is our mandatory packing. Orders to be placed by Legrand (India) Stockist in multiples of the same.

DMX³ Auxiliaries and Accessories

Cat.Nos	Description	MRP* ₹ / Unit	Pack
---------	-------------	------------------	------

Locking

Key Locking In "Open" Position

0288 27	Open position lock RONIS x 5 + 3 keys (Random)	■	1
0288 28	2 hole support frame for RONIS locks	■	1
4238 80	Key barrel and flat key with random mapping	■	1
4238 81	Key barrel and flat key with fixed mapping	■	1
4238 82	Key barrel and flat key with fixed mapping	■	1
4238 83	Key barrel and star key with random mapping	■	1
0281 94	Kit for key lock in d/o position DMX3	■	1

Locking

Key locking in the draw out position

4238 80	Key Lock (Only lock + key)	■	1
4238 83	Key barrel and star key with random mapping	■	1
0281 94	Kit for key lock in d/o position DMX3	■	1

Door locking

0288 20	Left-hand and right-hand side mounting	■	1
---------	--	---	---

Padlocks In "Open" Position

0288 21	Padlocking system for ACB	■	1
0288 24	Padlocking for button	■	1
0288 26	Padlocking system for shutters	■	1

* MRP - Maximum Retail Price Inclusive of all taxes including GST.
■ Price available on request.



4226 82



0288 64

DMX³ Auxiliaries and Accessories

Cat.Nos	Description	MRP* ₹ / Unit	Pack
---------	-------------	------------------	------

Automation control unit

4226 81	Standard unit	■	1
4226 82	Advanced unit	■	1
4226 89	Communication module	■	1

Equipment For Supply Invertors

0288 64	Interlock for DMX ³ 2500	■	1
0288 65	Interlock for DMX ³ 4000	■	1
0288 66	Interlock for DMX ³ 6300	■	1

Cable Interlock

0289 20	Type 1 (2600 mm)	■	1
0289 21	Type 2 (3000 mm)	■	1
0289 22	Type 3 (3600 mm)	■	1
0289 23	Type 4 (4000 mm)	■	1
0289 24	Type 5 (4600 mm)	■	1
0289 25	Type 6 (5600 mm)	■	1

Accessories

0288 25	Rating mis-insertion device	■	1
0288 23	Operations counter	■	1
0288 13	Inserted / test / Draw-out Contact	■	1
0288 14	Contact "ready to close" with charged springs	■	1
0288 15	Set of additional signalling contacts	■	1
0288 16	Signal Contact for Auxiliaries	■	1
0288 22	Door sealing IP 40	■	1
0288 79	Lifting plate	■	1

Bold Cat.Nos are products normally available with Legrand (India) Stockists. Cat.Nos that are not bold - delivery within 4 - 8 weeks from the date of order. Bold packing quantity is our mandatory packing. Orders to be placed by Legrand (India) Stockist in multiples of the same.

e-COMMUNICATION ARCHITECTURE

PROTECTION

MEASUREMENT

CONTROL AND SIGNALLING

RESIDENTIAL

DX³ Ph+N MCBs



4086 14 4085 90

EMDX³ energy meters



4120 45 4120 81 4120 91



4062 95 4062 52 0261 36

Auxiliaries and motorised control + I/O interface

COLLECTIVE HOUSING AND SMALL OFFICE BUILDINGS

DX³ MCBs



4086 14 4085 90

EMDX³ measuring units



4120 53

EMDX³ energy meters



4120 45 / 4120 81 / 4120 91



4106 57

Earth Leakage Module with integrated Measurement

CX3 EMS signalling and control modules



4149 29 / 4149 30 / 4149 32

CX3 EMS signalling and control modules



4149 31

CX³ + DX³ MCBs



4086 94 4125 56

Cx³ EMS modules:

4149 19 Single phase



4149 20 Three phase



4149 26 Pulse concentrator

Auxiliaries and motorised control + I/O interface



0288 15 0261 44 0261 36

Auxiliaries and motorised controls



0288 15 0261 44

CX3 EMS signalling and control modules



4149 29 / 4149 32

COMMERCIAL AND INDUSTRIAL



4234 28

DPX³ MCCBs



DMX3216L3ED4N

DMX³ ACB

EMDX³ measuring units



4120 53

4120 45 / 4120 91 EMDX³ energy meters



4149 23

CX³ EMS measuring module

Electronic DPX³ with integrated measurement



0283 07

DMX³ with electronic Protection unit

COMMUNICATION

REMOTE

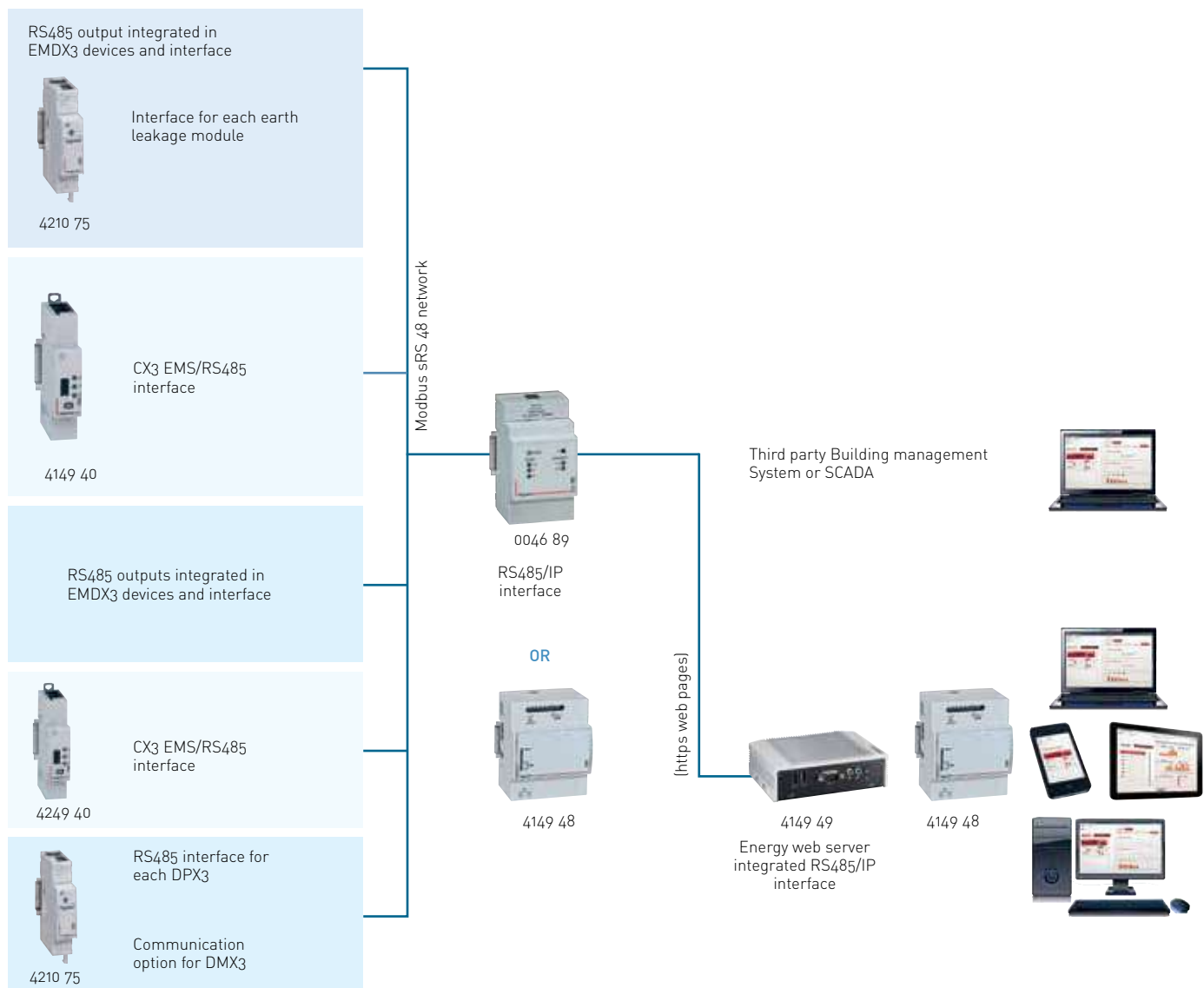

e-Communicating Infrastructure

Cat.Nos	Description	MRP* ₹ / Unit	Pack
---------	-------------	------------------	------

Power Supervision System

Control, Monitoring And Measurement

Communication Accessories For ACB

4149 45	EMS CX ³ Power Supply 230/12VDC	12870	1
4149 40	EMS CX ³ / RS485 Gateway	15220	1
4149 07	EMS CX ³ 10 Patch Cords 250MM	9500	10
4149 08	EMS CX ³ 10 Patch Cords 500MM	13690	10
4149 09	EMS CX ³ 5 Patch Cords 1000MM	10900	5
4149 10	EMS CX ³ 5 Patch Cord Connector	3820	5

Communication Modules

Signalling and Control Interface

Features

Signalling and control interface between the power supervision system and the **thermal magnetic or electronic circuit breakers**.

Equipped with analogue / digital inputs and relay outputs.

Can handle multiple circuit breakers.

24 inputs for collecting information from the signalling auxiliaries on the DPX³ and DMX³ circuit breakers: auxiliary contact NO position (1 input) or NO+NC position (2 inputs), fault signal (1 input)

6 outputs for: the remote control of the motor driven circuit breakers (2 outputs) and for tripping the circuit breakers (1 output)

Communication is ensured by the Modbus protocol. Address, speed and coding can be modified with

Configuration Kit.

0261 36	Sign. & Comm. Interface	38300	1
---------	-------------------------	-------	---

Communication Accessories for MCCB

Features

RS485 communication interface

Potential free contact for circuit breaker tripped status information max. 220 V 0.2 A

4210 75	DPX ³ Communication Interface	23510	1
4210 83	Input Voltage 24 V (2MOD)	6550	1

* MRP - Maximum Retail Price Inclusive of all taxes including GST.

■ Price available on request.

Red Cat. Nos - New Products

e-Communicating Infrastructure

Cat.Nos	Description	MRP* ₹ / Unit	Pack
---------	-------------	------------------	------

Communication Accessories For MCB

Features

RS485 communication interface

Potential free contact for circuit breaker tripped status information max. 220 V 0.2 A

Can be connected with DX3 add on Modules (4106 57/58/59)

4210 75	DPX ³ Communication Interface	23510	1
---------	--	-------	---

Communication Accessories

0261 45	BUS Plug-In Jumpers Kit - 0 to 9 Marking (10 of each)	■	1
0046 89	IP Converter RS485/ Ethernet AC	66590	1
1466 23	Stabilised Sw Mod Powrsup75 960	21944	1

Energy management multi-support web servers

Allow remote configuration, test, control and visualization, via a web browser on PCs, smartphones, web viewers, tablet computers, of data Converter

Features

In-built IP converter

Power supply: 9 to 28 V= with the help of a single-phase switching mode power supply Cat.No 1467 21 to be ordered separately. With the Legrand Power supervision system, circuit breakers are integrated in a supervision system

You can therefore check the status of the circuit breakers, measure the electrical values and control the circuit breakers remotely.

MODBUS protocol

4149 47	Mini Energy WS - 10	135660	1
4149 48	Web Server for 32 Meters	194952	1
4149 49	Web Server for Unlimited	■	1

Bold Cat.Nos are products normally available with Legrand (India) Stockists. Cat.Nos that are not bold - delivery within 4 - 8 weeks from the date of order. Bold packing quantity is our mandatory packing. Orders to be placed by Legrand (India) Stockist in multiples of the same.

DMX-SP

Air Circuit Breakers

For Smart & Reliable Low Voltage Power Distribution



The DMX-SP range of air circuit breakers and trip-free switches offers reliable protection for standard electrical installations. Designed for performance and durability, the range supports current ratings up to 2500A and breaking capacities up to 50kA, ensuring safe and dependable operation across a wide range of applications

Features

- Powered with Advanced MP2.10 and MP4.10 Protection units
- With Integrated LED / LCD display
- Fixed and draw-out configurations
- Available as ACBs and trip-free switches

Benefits

- Rotatable Rear Terminals
- Provides flexible installation options to adapt to different switchboard designs
- Delivers reliable performance in demanding operational conditions
- Lower Power Losses (Energy Efficient)

Scan to know more about the product.



DMX SP 2500

Air Circuit Breakers



- Range – 630 A to 2500 A
- Single Frame Size
- Options of Fixed and Drawout Versions
- Options of Manual & Electrical Versions
- Icu=Ics=Icw(1s)=50 kA
- Compact Dimensions
- Advanced Self Powered Electronic Protection Units
 - MP2.10 and MP4.10
- MP2.10 - Electronic PU with LED Display with LSIG + Neutral O/L + Over Temperature Protection + communication capable
- MP4.10 - Electronic PU with LSIG + Neutral O/L + Over Temperature Protection + LCD Display with Current Metering + 20 Trip History + 20 Alarms + Logical Selectivity
- Configurable LSING protection + communication capable
- Long time delay protection against overloads I_r from 0.2 to 1 x I_n (Step 1A) – OFF
- Long delay protection operation time t_r = 40 ms + 30 s (step 40 ms)
- Short time delay protection against short circuits I_{sd} from 1.5I_r to 10 I_r – OFF (step 1A)
- Short time delay protection operation time (t=k, I₂t=k) t_{sd} = 40 ms + 1 s (step 40 ms)
- Instantaneous protection against very high short circuits I_i from 2 to 15 I_n – OFF (step 1A)
- Earth fault current I_g from 0.2 x I_n – OFF (step 0.1I_n)
- Time delay on earth fault tripping (t=k, I₂t=k) I_g from 80 ms + 1s (step 40 ms)
- Neutral protection I_N = 50% – 100% – 150% – 200% – OFF
- In Built Temperature Protection
- Rotatable Terminals for Horizontal/Vertical Orientation⁽¹⁾
- Fast Operation
- Options to install various safety interlock
- Switchable Thermal Memory

DMXSP	1	08	N	4	E	D	2N
↓	↓	↓	↓	↓	↓	↓	↓
CB Series	Frame	Rating	BC	No. of Poles	Type of Spring Charging	Type of Mechanism	Type of Release
DMXS=DMX SP	1=DMX SP 2500	06=630A 08=800A 10=1000A 12=1250A 16=1600A 20=2000A 25=2500A	N=50kA	3=3Pole 4=4Pole	M=Manual Type E=Electrical with 240V AC ECD+CC & 240V AC S/T	F=Fixed D=Drawout	00=Trip Free 2N=MP2.10 LSIG 4N= MP4.10 LSIG

Type and frame size	Rated Current (A)	3P			4P		
		Cat.Nos	MRP*/₹/Unit	Pack	Cat.Nos	MRP*/₹/Unit	Pack

Manual Fixed Version With MP2.10 PU

DMX-SP- N 2500 Icu 50KA	630 A	DMXS106N3MF2N	196330	1	DMXS106N4MF2N	256940	1
	800 A	DMXS108N3MF2N	196330	1	DMXS108N4MF2N	256940	1
	1000 A	DMXS110N3MF2N	207350	1	DMXS110N4MF2N	273480	1
	1250 A	DMXS112N3MF2N	237660	1	DMXS112N4MF2N	312040	1
	1600 A	DMXS116N3MF2N	269190	1	DMXS116N4MF2N	339490	1
	2000 A	DMXS120N3MF2N	314850	1	DMXS120N4MF2N	399390	1
	2500 A	DMXS125N3MF2N	386460	1	DMXS125N4MF2N	442310	1

Manual Drawout Version With MP 2.10 PU

DMX-SP- N 2500 Icu 50KA Frame 1	630 A	DMXS106N3MD2N	240410	1	DMXS106N4MD2N	301010	1
	800 A	DMXS108N3MD2N	240410	1	DMXS108N4MD2N	301010	1
	1000 A	DMXS110N3MD2N	251440	1	DMXS110N4MD2N	317550	1
	1250 A	DMXS112N3MD2N	281730	1	DMXS112N4MD2N	356120	1
	1600 A	DMXS116N3MD2N	312440	1	DMXS116N4MD2N	382740	1
	2000 A	DMXS120N3MD2N	377350	1	DMXS120N4MD2N	440640	1
	2500 A	DMXS125N3MD2N	433000	1	DMXS125N4MD2N	507470	1

*MRP - Maximum Retail Price Inclusive of all taxes including GST.
⁽¹⁾Built in bothside rotatable terminals up-to 1600A as a standard offer.

Bold Cat.Nos are products normally available with Legrand (India) Stockists. Cat.Nos that are not bold - delivery within 4 - 8 weeks from the date of order. Bold packing quantity is our mandatory packing. Orders to be placed by Legrand (India) Stockist in multiples of the same.



DMX112N3MD2N

DMX SP 2500

Air Circuit Breakers

Type and frame size	Rated Current (A)	3P			4P		
		Cat.Nos	MRP*/₹/Unit	Pack	Cat.Nos	MRP*/₹/Unit	Pack

Electrical Fixed Version With MP2.10 PU With 240V AC, ECD+CC & 240V AC S/T

DMX-SP- N 2500 Icu 50KA	630 A	DMXS106N3EF2N	261240	1	DMXS106N4EF2N	321850	1
	800 A	DMXS108N3EF2N	261240	1	DMXS108N4EF2N	321850	1
	1000 A	DMXS110N3EF2N	272260	1	DMXS110N4EF2N	338380	1
	1250 A	DMXS112N3EF2N	302560	1	DMXS112N4EF2N	376940	1
	1600 A	DMXS116N3EF2N	334080	1	DMXS116N4EF2N	404390	1
	2000 A	DMXS120N3EF2N	379750	1	DMXS120N4EF2N	464300	1
	2500 A	DMXS125N3EF2N	451360	1	DMXS125N4EF2N	507200	1

Electrical Drawout Version With MP 2.10 PU With 240V AC, ECD+CC & 240V AC S/T

DMX-SP- N 2500 Icu 50KA	630 A	DMXS106N3ED2N	305310	1	DMXS106N4ED2N	365910	1
	800 A	DMXS108N3ED2N	305310	1	DMXS108N4ED2N	365910	1
	1000 A	DMXS110N3ED2N	316350	1	DMXS110N4ED2N	382450	1
	1250 A	DMXS112N3ED2N	346640	1	DMXS112N4ED2N	421010	1
	1600 A	DMXS116N3ED2N	377350	1	DMXS116N4ED2N	447630	1
	2000 A	DMXS120N3ED2N	442240	1	DMXS120N4ED2N	505540	1
	2500 A	DMXS125N3ED2N	497910	1	DMXS125N4ED2N	572360	1

Manual Fixed Version With MP4.10 PU

DMX-SP- N 2500 Icu 50KA	630 A	DMXS106N3MF4N	212420	1	DMXS106N4MF4N	278020	1
	800 A	DMXS108N3MF4N	212420	1	DMXS108N4MF4N	278020	1
	1000 A	DMXS110N3MF4N	224350	1	DMXS110N4MF4N	295900	1
	1250 A	DMXS112N3MF4N	257140	1	DMXS112N4MF4N	344860	1
	1600 A	DMXS116N3MF4N	297500	1	DMXS116N4MF4N	375200	1
	2000 A	DMXS120N3MF4N	347960	1	DMXS120N4MF4N	432130	1
	2500 A	DMXS125N3MF4N	418140	1	DMXS125N4MF4N	478560	1



DMXS116N3MF4N

Manual Drawout Version With MP 4.10 PU

DMX-SP- N 2500 Icu 50KA	630 A	DMXS106N3MD4N	244940	1	DMXS106N4MD4N	325680	1
	800 A	DMXS108N3MD4N	244940	1	DMXS108N4MD4N	325680	1
	1000 A	DMXS110N3MD4N	256180	1	DMXS110N4MD4N	343570	1
	1250 A	DMXS112N3MD4N	287040	1	DMXS112N4MD4N	393560	1
	1600 A	DMXS116N3MD4N	322670	1	DMXS116N4MD4N	422990	1
	2000 A	DMXS120N3MD4N	389670	1	DMXS120N4MD4N	476760	1
	2500 A	DMXS125N3MD4N	441170	1	DMXS125N4MD4N	549070	1

Electrical Fixed Version With MP4.10 PU With 240V AC, ECD+CC & 240V AC S/T

DMX-SP- N 2500 Icu 50KA	630 A	DMXS106N3EF4N	282660	1	DMXS106N4EF4N	348230	1
	800 A	DMXS108N3EF4N	282660	1	DMXS108N4EF4N	348230	1
	1000 A	DMXS110N3EF4N	294560	1	DMXS110N4EF4N	366110	1
	1250 A	DMXS112N3EF4N	327360	1	DMXS112N4EF4N	416580	1
	1600 A	DMXS116N3EF4N	369220	1	DMXS116N4EF4N	446920	1
	2000 A	DMXS120N3EF4N	419690	1	DMXS120N4EF4N	513110	1
	2500 A	DMXS125N3EF4N	488360	1	DMXS125N4EF4N	548780	1

* MRP - Maximum Retail Price Inclusive of all taxes including GST.

Bold Cat.Nos are products normally available with Legrand (India) Stockists. Cat.Nos that are not bold - delivery within 4 - 8 weeks from the date of order. Bold packing quantity is our mandatory packing. Orders to be placed by Legrand (India) Stockist in multiples of the same.

DMX SP 2500

Air Circuit Breakers

Type and frame size	Rated Current (A)	3P			4P		
		Cat.Nos	MRP*/₹/Unit	Pack	Cat.Nos	MRP*/₹/Unit	Pack

Electrical Drawout Version With MP 4.10 PU With 240V AC, ECD+CC & 240V AC S/T

DMX-SP- N 2500 Icu 50KA	630 A	DMXS106N3ED4N	330340	1	DMXS106N4ED4N	395900	1
	800 A	DMXS108N3ED4N	330340	1	DMXS108N4ED4N	395900	1
	1000 A	DMXS110N3ED4N	342280	1	DMXS110N4ED4N	413810	1
	1250 A	DMXS112N3ED4N	375060	1	DMXS112N4ED4N	465280	1
	1600 A	DMXS116N3ED4N	417020	1	DMXS116N4ED4N	494710	1
	2000 A	DMXS120N3ED4N	488760	1	DMXS120N4ED4N	558710	1
	2500 A	DMXS125N3ED4N	538720	1	DMXS125N4ED4N	619280	1

Switch Disconnector (Trip Free Switches) From 630 To 2500A Manual Fixed Version

DMX ³ - I 2500	630 A	DMXS106S3MF00	154260	1	DMXS106S4MF00	214870	1
	800 A	DMXS108S3MF00	154260	1	DMXS108S4MF00	214870	1
	1000 A	DMXS110S3MF00	165270	1	DMXS110S4MF00	231400	1
	1250 A	DMXS112S3MF00	195570	1	DMXS112S4MF00	269960	1
	1600 A	DMXS116S3MF00	227100	1	DMXS116S4MF00	297410	1
	2000 A	DMXS120S3MF00	271990	1	DMXS120S4MF00	357310	1
	2500 A	DMXS125S3MF00	344380	1	DMXS125S4MF00	400220	1

Manual Drawout Version

DMX ³ - I 2500	630 A	DMXS106S3MD00	198320	1	DMXS106S4MD00	258920	1
	800 A	DMXS108S3MD00	198320	1	DMXS108S4MD00	258920	1
	1000 A	DMXS110S3MD00	209350	1	DMXS110S4MD00	275460	1
	1250 A	DMXS112S3MD00	239660	1	DMXS112S4MD00	314030	1
	1600 A	DMXS116S3MD00	270360	1	DMXS116S4MD00	340650	1
	2000 A	DMXS120S3MD00	335260	1	DMXS120S4MD00	398560	1
	2500 A	DMXS125S3MD00	390920	1	DMXS125S4MD00	465380	1

* MRP - Maximum Retail Price Inclusive of all taxes including GST.
 Note - 1. For EF and EDO versions of Switch-disconnectors, please contact Sales office.
 For Voltages other than 220 - 250 V AC and DC, please order MF/MDO ACB and the required Voltage accessories

Bold Cat.Nos are products normally available with Legrand (India) Stockists. Cat.Nos that are not bold - delivery within 4 - 8 weeks from the date of order. Bold packing quantity is our mandatory packing. Orders to be placed by Legrand (India) Stockist in multiples of the same.

DMX SP 2500

Electronic Protection Units

Cat.Nos	Description	MRP* ₹ / Unit	Pack
0283 00	MP2.10 Protection Unit with rotating encoder for Adjustmen of Ir, tr, isd, tsd, li, lg and tg Possibility to enable/disable protections With Current Measurement and LCD display protection conditions Fault signaling and log	42090	1
0283 02	MP4.10 Protection Unit with rotating encoder for Adjustmen of Ir, tr, isd, tsd, li, lg and tg Possibility to enable/disable protections With Current Measurement and LCD display protection conditions Fault signaling and log	52480	1

Auxillaries Accessories

Motor Operator

0281 20	Motor operator 24V AC/DC DMX S	48510	1
0281 21	Motor operator 48V AC/DC DMX S	48510	1
0281 22	Motor operator 110-130V AC/DC	48510	1
0281 23	Motor operator 220-250V AC/DC	48510	1
0281 24	Motor operator 415V - 440V ac	48510	1

Closing Coil

0281 26	Closing coil 24V AC/DC DMX SP	8170	1
0281 27	Closing coil 48V AC/DC DMX SP	8170	1
0281 28	Closing coil 110-130V AC/DC DM	8170	1
0281 29	Closing coil 220-250V AC/DC DM	8170	1
0281 30	Closing coi 415-440V AC DMX S	8170	1

Shunt Release

0281 31	Shunt trip 24V AC/DC DMX SP	8170	1
0281 32	Shunt trip 48V AC/DC DMX SP	8170	1
0281 33	Shunt trip 110-130V AC/DC DMX	8170	1
0281 34	Shunt trip 220-250V AC/DC DMX	8170	1
0281 35	Shunt trip 415-440V AC DMX SP	8170	1

Undervoltage Release

0281 36	Undervoltage release 24V AC/DC	11040	1
0281 37	Undervoltage release 48V AC/DC	11040	1
0281 38	Undervoltage release 110-130V	11040	1
0281 39	Undervoltage release 220-250V	11040	1
0281 40	Undervoltage release 415-440V	11040	1

■ Price available on request.

* MRP - Maximum Retail Price Inclusive of all taxes including GST.

Red Cat. Nos - New Products

DMX SP 2500

Auxillaries Accessories

Cat.Nos	Description	MRP* ₹ / Unit	Pack
0288 62	Undervolt Rel T Delay 110V AC/DC	■	1
0288 63	Undervolt Rel T Delay 230V AC/DC	9140	1

Mechanical Accessories

Phase Barriers / Insulated Shields

6696 00	Fix Version 3P DMX SP	■	1
6696 01	Fix Version 4P DMX SP	■	1
6696 02	Insulation shields Draw-out Ve	2810	1
6696 03	Insulation shields Draw-out Ve	3750	1

Key Lock Open & Drawout Position

0281 91	Key Lock In Open & D/O Posit	■	1
4238 80	Key barrel and flat key with random mapping	■	1
4238 81	Key barrel and flat key with fixed mapping	■	1
4238 82	Key barrel and flat key with fixed mapping	■	1
4238 83	Key barrel and star key with random mapping	■	1
0281 84	Door lock for both right&left	6840	1
0281 87	Safety button for test positio	3160	1

Terminals

0288 84	Real terminals - flat connection	26720	1
0288 82	Real terminals - vertical connection	29690	1
0288 85	Real terminals - flat connection	34730	1
0288 83	Real terminals - vertical connection	40070	1
0288 96	Real terminals - vertical or horizontal	16150	1
0288 97	Real terminals - vertical or horizontal	21540	1

Additional Accessories

0281 88	Mechanical counter DMX SP	5260	1
0281 77	Padlock for button DMX SP	2090	1
6696 20	External Neutral DMX-SP 2500 M	23110	1
0281 73	Signalling contact inserted-tes	4120	1
0281 74	AUX ready to close-charged spr	4210	1
0281 75	Module with 6 aux contacts DMX	31560	1
0281 90	Mech Interlock two device	16870	1

Bold Cat.Nos are products normally available with Legrand (India) Stockists. Cat.Nos that are not bold - delivery within 4 - 8 weeks from the date of order. Bold packing quantity is our mandatory packing. Orders to be placed by Legrand (India) Stockist in multiples of the same.

NEW!

1000V Solution

Smart Protection Renewable Energy installations

DMX³ ACBs and DPX³ MCCBs are engineered to deliver reliable 1000V AC protection for critical applications across renewable energy, wind power, and rail infrastructure. Designed for high-performance environments, they combine robust protection, compact integration, and intelligent monitoring to support efficient and future-ready power distribution systems.

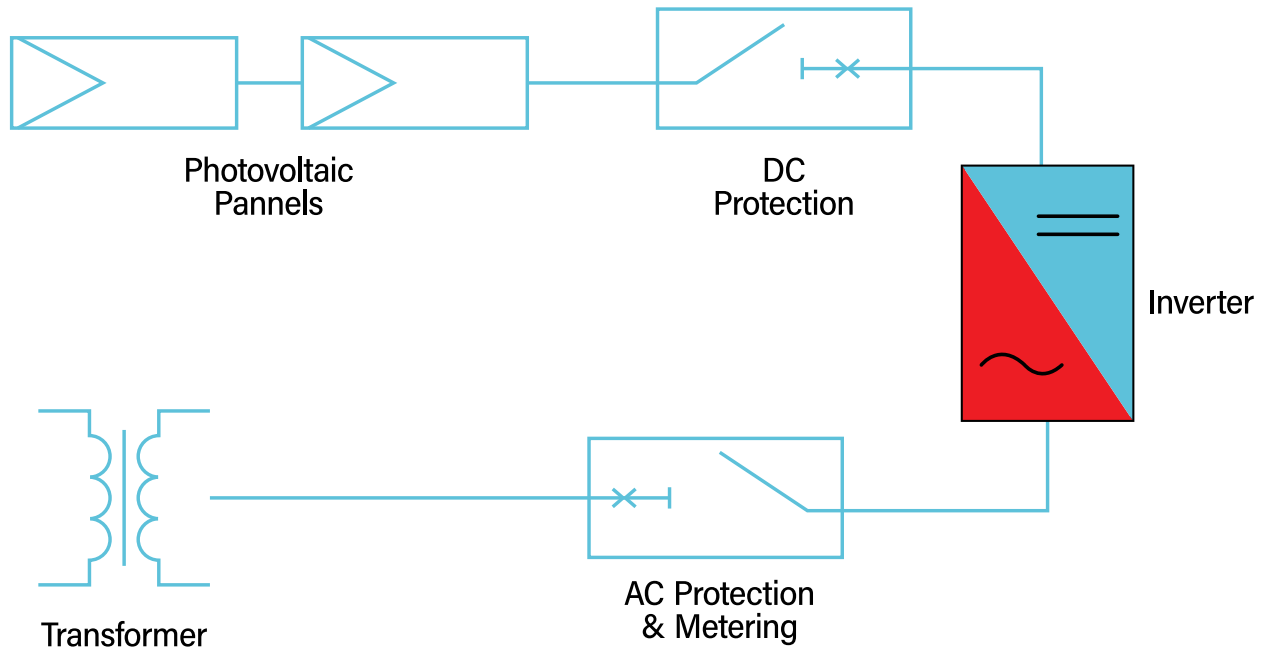

DMX³
1000V ACB



DPX³
1000V MCCB

Application Areas

Solar Power Plants



1000V DMX³ ACBs provide reliable protection at main distribution and grid interface points, while DPX³ MCCBs ensure efficient feeder and circuit protection across inverter outputs and distribution networks in large-scale photovoltaic installations.

Wind Energy Systems

Scan to know more about the product.



Legrand 1000V DMX³ ACBs deliver robust protection for turbine switchboards and main power distribution, while DPX³ MCCBs support dependable feeder-level protection within nacelles and wind farm electrical systems.

NEW!

DPX³ MCCBs

For Smart & Reliable
Low Voltage
Power Distribution



Key Highlights

- Thermal-magnetic and New Electronics protection trip unit- S1 & S10
- Zone Selective Interlocking with USB port and inbuilt LCD screen
- Customizable protection settings to match specific project power distribution requirements
- High breaking capacity up to 100 kA for dependable fault interruption
- Bluetooth connectivity for smartphone-based configuration and monitoring
- Connectivity with EMS and supervision systems for smarter energy management



DPX³ 630 and 1600

S1 and S10 protection units



DPX³630

DPX³1600

Scan to know more about the product.



DPX³ MCCB

DPX³ MCCB 125/160/250 HP

Category	Type	Rated Current (A)	3P			4P		
			Cat.Nos	MRP*/₹/Unit	Pack	Cat.Nos	MRP*/₹/Unit	Pack

Thermal Magnetic release -Fixed version

36 KA	DPX ³ 125HP	16	423600	14730	1	423610	18390	1	
		25	423602	14730	1	423612	18390	1	
		40	423604	14730	1	423614	18390	1	
		63	423606	14730	1	423616	18390	1	
		80	423607	14730	1	423617	18390	1	
		100	423608	14730	1	423618	18390	1	
		125	423609	17270	1	423619	22540	1	
	DPX ³ 160HP	160	423720	21480	1	423721	25290	1	
	DPX ³ 250HP	200	423011	38070	1	423026	48130	1	
		250	423012	42230	1	423027	51530	1	
	50 KA	DPX ³ 125HP	16	423640	19620	1	423650	24730	1
			25	423642	19620	1	423652	24730	1
			40	423644	19620	1	423654	24730	1
			63	423646	19620	1	423656	24730	1
80			423647	19620	1	423657	24730	1	
100			423648	19620	1	423658	24730	1	
125			423649	25710	1	423659	29640	1	
DPX ³ 160HP		160	423725	27940	1	423726	32500	1	
DPX ³ 250HP		200	423071	46120	1	423086	58260	1	
		250	423072	48680	1	423087	60610	1	
DPX ³ 250HP	200	423131	62160	1	423146	76480	1		
	250	423132	66060	1	423147	79610	1		

Thermal magnetic release with Electronic earth leakage module - Fixed version

36 KA	DPX ³ 125HP	16	■	■	■	423630	68920	1
		25	■	■	■	423632	68920	1
		40	■	■	■	423634	68920	1
		63	■	■	■	423636	68920	1
		80	■	■	■	423637	68920	1
		100	■	■	■	423638	68920	1
		125	■	■	■	423639	69290	1
	DPX ³ 160HP	160	■	■	■	423723	79550	1
	DPX ³ 250HP	200	■	■	■	423056	87110	1
		250	■	■	■	423057	93150	1

■ Price available on request.

* MRP - Maximum Retail Price inclusive of all taxes including GST.

Bold Cat.Nos are products normally available with Legrand (India) Stockists. Cat.Nos that are not bold - delivery within 4 - 8 weeks from the date of order. Bold packing quantity is our mandatory packing. Orders to be placed by Legrand (India) Stockist in multiples of the same.

DPX³ MCCB

DPX³ MCCB 125/160/250 HP

Category	Type	Rated Current (A)	3P			4P		
			Cat.Nos	MRP*/₹/Unit	Pack	Cat.Nos	MRP*/₹/Unit	Pack

Thermal magnetic release with Electronic earth leakage module - Fixed version

50 KA	DPX ³ 125HP	16	■	■	■	423670	77030	1
		25	■	■	■	423672	77030	1
		40	■	■	■	423674	77030	1
		63	■	■	■	423676	77030	1
		80	■	■	■	423677	77030	1
		100	■	■	■	423678	77030	1
		125	■	■	■	423679	85030	1
	DPX ³ 160HP	160	■	■	■	423728	85460	1
	DPX ³ 250HP	200	■	■	■	423116	104360	1
		250	■	■	■	423117	110880	1

Accessories of DPX³ 125 HP, 160HP

Cat.Nos	Description	MRP* ₹ / Unit	Pack	Cat.Nos	Description	MRP* ₹ / Unit	Pack
423810	DPX ³ 125HP RH DIRECT STD	1810	1	421049	Padlock for locking in "open" position For DPX ³ 160/250 and DPX ³ 125/160/250 HP	■	1
423811	DPX ³ 125HP RH DIRECT EMERG	1970	1	423876	CAGE TERMINALS DPX ³ 125 HP(3P)	11050	1
423812	DPX ³ 125HP RH VARI DEPTH STD	2980	1	423877	CAGE TERMINALS DPX ³ 125 HP(4P)	14620	1
423813	DPX ³ 125HP RH VARI DEPTH EMERG	3230	1	423884	CAGE TERMINALS DPX ³ 125 HP(3P)	■	1
423805	DPX ³ 125&250HPKEYLOCK ACC VARI	3160	1	423885	CAGE TERMINALS DPX ³ 125 HP(4P)	■	1
423806	AUXILIARY CNT BLOCK 1N/C+1 N/O	2010	1	423888	3 LINKS SET FOR TP DRX125A EXP	1000	1
423825	Plate for mounting and interlocking of 2 DPX ³ 125/160 HP	■	1	423889	4 LINKS SET FOR FP DRX125A EXP	1350	1
423827	Interlocking mechanism for 2 fixed DPX ³ 125/160/250 HP MCCBs	■	1	423891	DPX ³ 125HP REAR TERMINALS 4P	6020	1
423828	Interlocking mechanism for 2 fixed DPX ³ 125/160/250 HP MCCBs with electronic module	■	1	423892	DPX ³ 125HP REAR TERMINALS 4P	8070	1
423834	Set of 2 insulated shields for DPX ³ 125/160/250 HP 3P	■	1	423893	SHIELDS FOR FRONT TERMINAL(HIG)	4150	1
423835	Set of 3 insulated shields for DPX ³ 125/160/250 HP 4P	■	1	423894	SHIELDS FOR FRONT TERMINAL(HIG)	3680	1

■ Price available on request.

* MRP - Maximum Retail Price Inclusive of all taxes including GST.

Bold Cat.Nos are products normally available with Legrand (India) Stockists. Cat.Nos that are not bold - delivery within 4 - 8 weeks from the date of order. Bold packing quantity is our mandatory packing. Orders to be placed by Legrand (India) Stockist in multiples of the same.

DPX³ MCCB

DPX³ 250 HP MCCB with New Electronics S1 Protection Unit

- DPX³ MCCB with electronic S1 (LSI) protection unit
- Configurable Protections with Enable and Disable possibility
 - Ics=100%Icu
 - Protection against Overloads:
 - Ir adjustable from OFF-0.4 to 1 x In
 - tr adjustable- 5s
 - Protection against Short Circuits:
 - Isd adjustable 1.5 to 10Ir
 - tsd - 100ms
 - Breaking Capacity – 36kA, 50kA, 70kA & 100kA

Category	Type	Rated Current (A)	3P			4P		
			Cat.Nos	MRP*/₹/Unit	Pack	Cat.Nos	MRP*/₹/Unit	Pack

Electronic S1 (LSI) Protection Unit

36 KA	DPX ³ 250HP	40	423200	■	1	423205	■	1
		100	423201	■	1	423206	■	1
		160	423202	■	1	423207	■	1
		250	423203	■	1	423208	■	1
50 KA	DPX ³ 250HP	40	423220	■	1	423225	■	1
		100	423221	■	1	423226	■	1
		160	423222	■	1	423227	■	1
		250	423223	■	1	423228	■	1
70 KA	DPX ³ 250HP	40	423240	■	1	423245	■	1
		100	423241	■	1	423246	■	1
		160	423242	■	1	423247	■	1
		250	423243	■	1	423248	■	1
100 KA	DPX ³ 250HP	40	423250	■	1	423255	■	1
		100	423251	■	1	423256	■	1
		160	423252	■	1	423257	■	1
		250	423253	■	1	423258	■	1

Electronic S1 (LSI) Protection Unit with Electronic earth leakage module - Fixed version

36 KA	DPX ³ 250HP	40	■	■	■	423215	■	1
		100	■	■	■	423216	■	1
		160	■	■	■	423217	■	1
		250	■	■	■	423218	■	1
50 KA	DPX ³ 250HP	40	■	■	■	423235	■	1
		100	■	■	■	423236	■	1
		160	■	■	■	423237	■	1
		250	■	■	■	423238	■	1

■ Price available on request.

* MRP - Maximum Retail Price Inclusive of all taxes including GST.

Bold Cat.Nos are products normally available with Legrand (India) Stockists. Cat.Nos that are not bold - delivery within 4 - 8 weeks from the date of order. Bold packing quantity is our mandatory packing. Orders to be placed by Legrand (India) Stockist in multiples of the same.

DPX³ MCCB

DPX³ 250 HP MCCB with New Electronics S10 Protection Unit

- DPX³ MCCB with electronic S10 (LSIg) & energy metering protection unit
- Configurable Protections with Enable and Disable possibility
 - Ics=100%Icu
 - Protection against Overloads:
 - Ir adjustable from OFF-0.2 to 1 x In
 - tr adjustable from 3 to 30s
 - Protection against Short Circuits:
 - Isd adjustable from OFF-1.5 to 10 x Ir
 - tsd adjustable from 0 to 0.5s
 - Inbuilt Instantaneous Protection: - li – Fixed and 2 to 15x In through PCS
 - Protection against Ground Fault:
 - Ig adjustable from 0.2 to 1 In & OFF
 - tg adjustable from 0.80ms to 1s
 - Protection against Neutral Fault: OFF-50% -100% -150% -200%
 - Breaking Capacity – 36kA, 50kA, 70kA & 100kA
 - Integrated energy metering with accuracy class 1
 - Measure for currents, voltage, frequency, power, energy, THD and Individual harmonics
 - Internal Battery with battery measure function
 - Communication ready
 - Logical Selectivity Ready (Zone Selective Interlocking)
 - In Built USB Port for Software Diagnosis
 - Switchable Thermal Memory
 - Suitable for Isolation

Category	Type	Rated Current (A)	3P			4P		
			Cat.Nos	MRP*/₹/Unit	Pack	Cat.Nos	MRP*/₹/Unit	Pack

Electronic S10 (LSIg) Protection Unit

36 KA	DPX ³ 250HP	40	423400	■	1	423405	■	1
		100	423401	■	1	423406	■	1
		160	423402	■	1	423407	■	1
		250	423403	■	1	423408	■	1
50 KA	DPX ³ 250HP	40	423420	■	1	423425	■	1
		100	423421	■	1	423426	■	1
		160	423422	■	1	423427	■	1
		250	423423	■	1	423428	■	1
70 KA	DPX ³ 250HP	40	423440	■	1	423445	■	1
		100	423441	■	1	423446	■	1
		160	423442	■	1	423447	■	1
		250	423443	■	1	423448	■	1
100 KA	DPX ³ 250HP	40	423450	■	1	423455	■	1
		100	423451	■	1	423456	■	1
		160	423452	■	1	423457	■	1
		250	423453	■	1	423458	■	1

Electronic S10 (LSIg) Protection Unit with Measure

36 KA	DPX ³ 250HP	40	423460	■	1	423465	■	1
		100	423461	■	1	423466	■	1
		160	423462	■	1	423467	■	1
		250	423463	■	1	423468	■	1
50 KA	DPX ³ 250HP	40	423480	■	1	423485	■	1
		100	423481	■	1	423486	■	1
		160	423482	■	1	423487	■	1
		250	423483	■	1	423488	■	1
70 KA	DPX ³ 250HP	40	423500	■	1	423505	■	1
		100	423501	■	1	423506	■	1
		160	423502	■	1	423507	■	1
		250	423503	■	1	423508	■	1
100 KA	DPX ³ 250HP	40	423510	■	1	423515	■	1
		100	423511	■	1	423516	■	1
		160	423512	■	1	423517	■	1
		250	423513	■	1	423518	■	1

■ Price available on request.

* MRP - Maximum Retail Price Inclusive of all taxes including GST.

Bold Cat.Nos are products normally available with Legrand (India) Stockists. Cat.Nos that are not bold - delivery within 4 - 8 weeks from the date of order. Bold packing quantity is our mandatory packing. Orders to be placed by Legrand (India) Stockist in multiples of the same.

DPX³ MCCB

DPX³ 250 HP MCCB with New Electronics S10 Protection Unit

Category	Type	Rated Current (A)	3P			4P		
			Cat.Nos	MRP*/₹/Unit	Pack	Cat.Nos	MRP*/₹/Unit	Pack
Electronic S10 (LSIg) Protection Unit with Electronic earth leakage module - Fixed version								
36 KA	DPX ³ 250HP	40	■	■	■	423475	■	1
		100	■	■	■	423476	■	1
		160	■	■	■	423477	■	1
		250	■	■	■	423478	■	1
50 KA	DPX ³ 250HP	40	■	■	■	423495	■	1
		100	■	■	■	423496	■	1
		160	■	■	■	423497	■	1
		250	■	■	■	423498	■	1

Cat.Nos	Description	MRP* ₹ / Unit	Pack
---------	-------------	------------------	------

Accessories of DPX³ 250 HP

423814	DPX ³ 250HP RH DIRECT STD	1810	1
423815	DPX ³ 250HP RH DIRECT EMERG	1970	1
423816	DPX ³ 250HP RH VARI DEPTH STD	2980	1
423817	DPX ³ 250HP RH VARI DEPTH EMERG	3230	1
423804	Locking supports for direct handle	■	1
423805	Locking supports for vari-depth handle	■	1
423806	1 N/C + 1 N/O auxiliary contact for rotary handles	■	1
423840	Front installation motor operators-24 V AC	■	1
423841	Front installation motor operators- 48 V AC	■	1
423842	Front installation motor operators- 110 V AC	■	1
423843	Front installation motor operators- 230 V AC	■	1
423845	Locking support for motor operators Cat.Nos 4 238 40/41/42/43. To be equipped with universal keylocks Cat.No 4 238 80/81/82/83	■	1
423846	Padlock for motor operators Cat.Nos 4 238 40/41/42/43	■	1

■ Price available on request.

* MRP - Maximum Retail Price Inclusive of all taxes including GST.

Cat.Nos	Description	MRP* ₹ / Unit	Pack
---------	-------------	------------------	------

Accessories of DPX³ 250 HP

423834	Set of 2 insulated shields for DPX ³ HP 125/250 3P	■	
423835	Set of 3 insulated shields for DPX ³ HP 125/250 4P	■	
421049	Padlock for locking in "open" position for DPX ³ 160/250 and DPX ³ 125/250 HP	■	
423830	DPX ³ 250 HP CAGE TERMINAL FOR	4460	1
423831	DPX ³ 250 HP CAGE TERMINAL FOR	5800	1
423821	DPX ³ 250HP REAR TERMINALS 3P	6080	1
423822	DPX ³ 250HP REAR TERMINALS 4P	8190	1
625014	TP SPRDR LINK SET FOR DPX250ER	1020	1
625018	FP SPDR LINK SET FOR DPX250ER	1380	1
421011	DPX ³ aux cont & fault signals	1620	1
421012	DPX ³ SHUNT RELEASE-12VAC/DC	3600	1
421013	DPX ³ shu.rel-coil vol.24VAC/DC	3600	1
421014	DPX ³ SHUNT RELEASE-48VAC/DC	3600	1
421015	DPX ³ shunt release 110V-130V AC	3600	1
421016	DPX ³ shunt release 220V-277V AC	3600	1
421017	DPX ³ shunt release 380V-415V AC	3600	1
421018	DPX ³ UNDER VOLT.REL-12VAC/DC	4510	1

Bold Cat.Nos are products normally available with Legrand (India) Stockists. Cat.Nos that are not bold - delivery within 4 - 8 weeks from the date of order. Bold packing quantity is our mandatory packing. Orders to be placed by Legrand (India) Stockist in multiples of the same.

DPX³ MCCB

DPX³ 250 HP MCCB with New Electronics S10 Protection Unit

Cat.Nos	Description	MRP* ₹ / Unit	Pack
Accessories of DPX³ 250 HP			
421019	DPX ³ UNDER VOLT.REL-24VAC/DC	4510	1
421020	DPX ³ UNDER VOLT.REL-48VAC/DC	4510	1
421021	DPX ³ UNDER VOLT.REL-110VAC/DC	4460	1
421022	DPX ³ Undervoltage release 200V- 240VAC	4460	1
421023	DPX ³ UNDER VOLT.REL-277AVC/DC	4460	1
421024	DPX ³ Undervoltage release 380V- 415V AC	4460	1
421025	DPX ³ UND.VOL.REL-440-480VAC/DC	4460	1
026190	Time-lag modules - 3 Module	■	1
026191	Time-lag modules-3 Module	■	1
421049	Padlocking for locking in "Open" position for DPX ³ 125/250HP	28420	1
423814	DPX ³ 250HP RH DIRECT STD	1810	1
423815	DPX ³ 250HP RH DIRECT EMERG	1970	1
423816	DPX ³ 250HP RH VARI DEPTH STD	2980	1
423817	DPX ³ 250HP RH VARI DEPTH EMERG	3230	1
423806	AUXILIARY CNT BLOCK 1N/C+1 N/O	2010	1
423850	Plug-in bases for DPX ³ 250 HP - 3P	■	1
423851	Plug-in bases for DPX ³ 250 HP - 4P	■	1
423852	Plug-in Plug-in mobile part kit for DPX ³ 250 HP - 3P	■	1
423853	Plug-in Plug-in mobile part kit for DPX ³ 250 HP - 4P	■	1
423863	Locking support for plug-in version. To be equipped with universal keylocks Cat.No 4 238 80/81/82/83	■	1
423860	Debro-lift mechanism for DPX ³ 250 HP ; Supplied with handle - 3P	■	1
423861	Debro-lift mechanism for DPX ³ 250 HP ; Supplied with handle - 4P	■	1

■ Price available on request.

* MRP - Maximum Retail Price Inclusive of all taxes including GST.

Cat.Nos	Description	MRP* ₹ / Unit	Pack
Accessories of DPX³ 250 HP			
423855	Draw-out front cover masks for DPX ³ 250 HP alone	■	1
423856	Draw-out front cover masks for DPX ³ 250 HP with motor-driven handle	■	1
423862	Enable locking of DPX ³ 250 HP in draw-out position. To be equipped with universal keylocks Cat.No 4 238 80/81/82/83	■	1
423864	Enable padlocking of DPX ³ HP in draw-out position	■	1
422230	Automatic auxiliary contact for DPX ³ HP draw-out version (up to 2 contacts by DPX ³ -HP)	■	1
009819	Signalling contact plugged-in / drawn-out	■	1
421048	Signalling Contact For DPX ³ 250 HP plug-in versions	■	1

Bold Cat.Nos are products normally available with Legrand (India) Stockists. Cat.Nos that are not bold - delivery within 4 - 8 weeks from the date of order. **Bold** packing quantity is our mandatory packing. Orders to be placed by Legrand (India) Stockist in multiples of the same.

DPX³ MCCB

DPX³ MCCB with New Electronics S1 Protection Unit

DPX³ MCCB with electronic S1 (LSI) protection unit

- Configurable Protections with Enable and Disable possibility
- Range: 320A – 1600A, Ics=100%Icu, Two Optimum Frames
- Protection against Overloads:
 - Ir adjustable from OFF-0.4 to 1 x In
 - tr adjustable- 5s
- Protection against Short Circuits:
 - I_{sd} adjustable 1.5 to 10I_r
 - tsd - 100ms
- Breaking Capacity – 36kA, 50kA, 70kA & 100kA

Category	Type	Rated Current (A)	3P			4P		
			Cat.Nos	MRP*/₹/Unit	Pack	Cat.Nos	MRP*/₹/Unit	Pack

Electronic S1 (LSI) Protection Unit

36 KA	DPX ³ 630	320	422499	57520	1	422504	70300	1
		400	422500	57520	1	422505	70300	1
		500	422501	64370	1	422506	86340	1
		630	422502	65720	1	422507	88170	1
	DPX ³ 1600	800	422540	110020	1	422546	131260	1
		1000	422541	164380	1	422547	242590	1
		1250	422542	198080	1	422548	295050	1
		1600	422543	245140	1	422549	329270	1
50 KA	DPX ³ 630	320	422509	65310	1	422514	83310	1
		400	422510	65310	1	422515	83310	1
		500	422511	76320	1	422516	95410	1
		630	422512	76320	1	422517	95410	1
	DPX ³ 1600	800	422552	126500	1	422558	155370	1
		1000	422553	175950	1	422559	245210	1
		1250	422554	213510	1	422560	311220	1
		1600	422555	299020	1	422561	352010	1

■ Price available on request.

* MRP - Maximum Retail Price Inclusive of all taxes including GST.

Bold Cat.Nos are products normally available with Legrand (India) Stockists. Cat.Nos that are not bold - delivery within 4 - 8 weeks from the date of order. Bold packing quantity is our mandatory packing. Orders to be placed by Legrand (India) Stockist in multiples of the same.

DPX³ MCCB

DPX³ MCCB with New Electronics S1 Protection Unit

Category	Type	Rated Current (A)	3P			4P		
			Cat.Nos	MRP*/₹/Unit	Pack	Cat.Nos	MRP*/₹/Unit	Pack
Electronic S1 (LSI) Protection Unit with Electronic Earth Leakage Module - Fixed version								
70 KA	DPX ³ 630	320	422519	82810	1	422524	106900	1
		400	422520	82810	1	422525	106900	1
		500	422521	89510	1	422526	120180	1
		630	422522	89510	1	422527	120180	1
	DPX ³ 1600	800	422564	165030	1	422570	208860	1
		1000	422565	231270	1	422571	330060	1
		1250	422566	276950	1	422572	385070	1
		1600	422567	372320	1	422573	458410	1
100 KA	DPX ³ 630	320	422529	■	1	422534	■	1
		400	422530	■	1	422535	■	1
		500	422531	■	1	422536	■	1
		630	422532	■	1	422537	■	1
	DPX ³ 1600	800	422576	■	1	422582	■	1
		1000	422577	■	1	422583	■	1
		1250	422578	■	1	422584	■	1

■ Price available on request.

* MRP - Maximum Retail Price Inclusive of all taxes including GST.

Bold Cat.Nos are products normally available with Legrand (India) Stockists. Cat.Nos that are not bold - delivery within 4 - 8 weeks from the date of order. Bold packing quantity is our mandatory packing. Orders to be placed by Legrand (India) Stockist in multiples of the same.

DPX³ MCCB

DPX³ MCCB with New Electronics S10 Protection Unit

- DPX³ MCCB with electronic S10 (LSIg) & energy metering protection unit
- Configurable Protections with Enable and Disable possibility
 - Range: 250A – 1600A, Ics=100%Icu, Two Optimum Frames
 - Protection against Overloads:
 - Ir adjustable from OFF-0.2 to 1 x In
 - tr adjustable from 3 to 30s
 - Protection against Short Circuits:
 - Isd adjustable from OFF-1.5 to 10 x Ir
 - tsd adjustable from 0 to 0.5s
 - Inbuilt Instantaneous Protection:
 - li – Fixed and 2 to 15x In through PCS
 - Protection against Ground Fault:
 - Ig adjustable from 0.2 to 1 In & OFF
 - tg adjustable from 0.80ms to 1s
 - Protection against Neutral Fault:
 - OFF-50% -100% -150% -200%
 - Breaking Capacity – 36kA, 50kA, 70kA & 100kA
 - Integrated energy metering with accuracy class 1
 - Measure for currents, voltage, frequency, power, energy, THD and Individual harmonics
 - Internal Battery with battery measure function
 - Communication ready
 - Logical Selectivity Ready (Zone Selective Interlocking)
 - In Built USB Port for Software Diagnosis
 - Switchable Thermal Memory
 - Suitable for Isolation

Category	Type	Rated Current (A)	3P			4P		
			Cat.Nos	MRP*/₹/Unit	Pack	Cat.Nos	MRP*/₹/Unit	Pack

Electronic S10 (LSIg) Protection Unit

36 KA	DPX ³ 630	320	422821	76110	1	422826	82520	1
		400	422822	76110	1	422827	82520	1
		500	422823	79020	1	422828	95080	1
		630	422824	79020	1	422829	95080	1
	DPX ³ 1600	800	422921	160140	1	422926	193040	1
		1000	422922	212790	1	422927	280000	1
		1250	422923	239110	1	422928	320250	1
		1600	422924	248620	1	422929	376070	1
50 KA	DPX ³ 630	320	422831	77040	1	422836	89620	1
		400	422832	77040	1	422837	89620	1
		500	422833	84560	1	422838	106640	1
		630	422834	84560	1	422839	106640	1
	DPX ³ 1600	800	422931	185370	1	422936	210990	1
		1000	422932	230260	1	422937	291870	1
		1250	422933	254420	1	422938	325590	1
		1600	422934	271440	1	422939	386410	1
70 KA	DPX ³ 630	320	422841	90350	1	422846	111480	1
		400	422842	90350	1	422847	111480	1
		500	422843	104040	1	422848	141570	1
		630	422844	104040	1	422849	141570	1
	DPX ³ 1600	800	422941	174500	1	422946	210450	1
		1000	422942	243910	1	422947	377350	1
		1250	422943	339800	1	422948	436840	1
		1600	422944	458830	1	422949	514960	1

■ Price available on request.

* MRP - Maximum Retail Price Inclusive of all taxes including GST.

Bold Cat.Nos are products normally available with Legrand (India) Stockists. Cat.Nos that are not bold - delivery within 4 - 8 weeks from the date of order. Bold packing quantity is our mandatory packing. Orders to be placed by Legrand (India) Stockist in multiples of the same.

DPX³ MCCB

DPX³ MCCB with New Electronics S10 Protection Unit

Category	Type	Rated Current (A)	3P			4P		
			Cat.Nos	MRP*/₹/Unit	Pack	Cat.Nos	MRP*/₹/Unit	Pack

Electronic S10 (LSIg) Protection Unit

100 KA	DPX ³ 630	320	422851	■	1	422856	■	1
		400	422852	■	1	422857	■	1
		500	422853	■	1	422858	■	1
		630	422854	■	1	422859	■	1
	DPX ³ 1600	800	422951	■	1	422956	■	1
		1000	422952	■	1	422957	■	1
		1250	422953	■	1	422958	■	1

Electronic S10 (LSIg) Protection Unit with Measure

36 KA	DPX ³ 630	320	422861	95430	1	422866	108530	1
		400	422862	95430	1	422867	108530	1
		500	422863	101280	1	422868	122920	1
		630	422864	101280	1	422869	122920	1
	DPX ³ 1600	800	422961	184500	1	422966	214950	1
		1000	422962	235660	1	422967	309620	1
		1250	422963	255580	1	422968	345110	1
		1600	422964	270760	1	422969	400330	1
50 KA	DPX ³ 630	320	422871	100240	1	422876	115720	1
		400	422872	100240	1	422877	115720	1
		500	422873	110320	1	422878	134660	1
		630	422874	110320	1	422879	134660	1
	DPX ³ 1600	800	422971	166710	1	422976	201150	1
		1000	422972	199110	1	422977	299760	1
		1250	422973	283980	1	422978	366810	1
		1600	422974	335260	1	422979	426950	1
70 KA	DPX ³ 630	320	422881	113550	1	422886	133940	1
		400	422882	113550	1	422887	133940	1
		500	422883	126830	1	422888	163140	1
		630	422884	126830	1	422889	163140	1
	DPX ³ 1600	800	422981	177080	1	422986	229750	1
		1000	422982	280030	1	422987	371580	1
		1250	422983	322040	1	422988	426420	1
		1600	422984	426560	1	422989	498450	1
100 KA	DPX ³ 630	320	422891	■	1	422896	■	1
		400	422892	■	1	422897	■	1
		500	422893	■	1	422898	■	1
		630	422894	■	1	422899	■	1
	DPX ³ 1600	800	422991	■	1	422996	■	1
		1000	422992	■	1	422997	■	1
		1250	422993	■	1	422998	■	1

■ Price available on request.

* MRP - Maximum Retail Price Inclusive of all taxes including GST.

Bold Cat.Nos are products normally available with Legrand (India) Stockists. Cat.Nos that are not bold - delivery within 4 - 8 weeks from the date of order. Bold packing quantity is our mandatory packing. Orders to be placed by Legrand (India) Stockist in multiples of the same.

DPX³ MCCB

DPX³ MCCB with Thermal Magnetic Protection Unit

- Range: 16A – 1250A, Ics=100%Icu, Four Optimum Frames
 - Thermal Adjustable – 0.8 to 1In, Magnetic Adjustable** – 5 to 10In
 - Breaking Capacity# – 16kA, 25kA, 36kA, 50kA, 70kA & 100kA
 - Option for In built or add on module for Earth Leakage Protection##
 - Adjustable sensitivity: 0.03 - 0.3 - 1 - 3 A
 - Adjustable tripping: 0 - 0.3 - 1 - 3s
 - Suitable for Isolation
- ** Fixed at 10In for DPX³ 160
 # Refer Catalogue for frame wise data
 ## For DPX³ 160, DPX³ 250 and DPX³ 630 Only

Category	Type	Rated Current (A)	3P			4P		
			Cat.Nos	MRP*/₹/Unit	Pack	Cat.Nos	MRP*/₹/Unit	Pack

Thermal Magnetic : O/L & S/C Protection

16 KA	DPX ³ 160	16	4200 00	9700	1	4200 10	12920	1
		25	4200 01	9700	1	4200 11	12920	1
		40	4200 02	9700	1	4200 12	12920	1
		63	4200 03	9700	1	4200 13	12920	1
		80	4200 04	9700	1	4200 14	12920	1
		100	4200 05	9700	1	4200 15	12920	1
		125	4200 06	10490	1	4200 16	13010	1
		160	4200 07	13540	1	4200 17	17040	1
25 KA	DPX ³ 160	16	4200 40	11340	1	4200 50	15760	1
		25	4200 41	11340	1	4200 51	15760	1
		40	4200 42	11340	1	4200 52	15760	1
		63	4200 43	11340	1	4200 53	15760	1
		80	4200 44	11340	1	4200 54	15760	1
		100	4200 45	11340	1	4200 55	15760	1
		125	4200 46	16390	1	4200 56	19900	1
		160	4200 47	21310	1	4200 57	25340	1
	DPX ³ 250	200	4202 08	29450	1	4202 18	35580	1
		250	4202 09	34140	1	4202 19	46010	1

■ Price available on request.

* MRP - Maximum Retail Price Inclusive of all taxes including GST.

Bold Cat.Nos are products normally available with Legrand (India) Stockists. Cat.Nos that are not bold - delivery within 4 - 8 weeks from the date of order. Bold packing quantity is our mandatory packing. Orders to be placed by Legrand (India) Stockist in multiples of the same.

DPX³ MCCB

DPX³ MCCB with Thermal Magnetic Protection Unit

Category	Type	Rated Current (A)	3P			4P		
			Cat.Nos	MRP*/₹/Unit	Pack	Cat.Nos	MRP*/₹/Unit	Pack
Thermal Magnetic : O/L & S/C Protection								
36 KA	DPX ³ 160	16	4200 80	14360	1	4200 90	17930	1
		25	4200 81	14360	1	4200 91	17930	1
		40	4200 82	14360	1	4200 92	17930	1
		63	4200 83	14360	1	4200 93	17930	1
		80	4200 84	14360	1	4200 94	17930	1
		100	4200 85	14360	1	4200 95	17930	1
		125	4200 86	16850	1	4200 96	21980	1
		160	4200 87	21700	1	4200 97	25550	1
	DPX ³ 250	200	4202 38	37120	1	4202 48	46930	1
		250	4202 39	41180	1	4202 49	50260	1
	DPX ³ 630	320	4220 01	49730	1	4220 06	56480	1
		400	4220 02	49730	1	4220 07	57720	1
		500	4220 03	59830	1	4220 08	71170	1
		630	4220 04	59830	1	4220 09	73000	1
	DPX ³ 1600	800	4222 52	91310	1	4222 57	106190	1
1000		4222 53	107570	1	4222 58	150650	1	
1250		4222 54	166160	1	4222 59	181240	1	

■ Price available on request.

* MRP - Maximum Retail Price inclusive of all taxes including GST.

Bold Cat.Nos are products normally available with Legrand (India) Stockists. Cat.Nos that are not bold - delivery within 4 - 8 weeks from the date of order. Bold packing quantity is our mandatory packing. Orders to be placed by Legrand (India) Stockist in multiples of the same.

DPX³ MCCB

DPX³ MCCB with Thermal Magnetic Protection Unit

Category	Type	Rated Current (A)	3P			4P		
			Cat.Nos	MRP*/₹/Unit	Pack	Cat.Nos	MRP*/₹/Unit	Pack
Thermal Magnetic : O/L & S/C Protection								
50 KA	DPX ³ 160	16	4201 20	19130	1	4201 30	24110	1
		25	4201 21	19130	1	4201 31	24110	1
		40	4201 22	19130	1	4201 32	24110	1
		63	4201 23	19130	1	4201 33	24110	1
		80	4201 24	19130	1	4201 34	24110	1
		100	4201 25	19130	1	4201 35	24110	1
		125	4201 26	25080	1	4201 36	28900	1
		160	4201 27	28220	1	4201 37	32830	1
	DPX ³ 250	200	4202 68	44980	1	4202 78	56820	1
		250	4202 69	47470	1	4202 79	59100	1
	DPX ³ 630	320	4220 15	49940	1	4220 20	65810	1
		400	4220 16	55150	1	4220 21	65810	1
		500	4220 17	63150	1	4220 22	86220	1
		630	4220 18	68270	1	4220 23	88400	1
	DPX ³ 1600	800	4222 64	100520	1	4222 69	125410	1
		1000	4222 65	153010	1	4222 70	177010	1
		1250	4222 66	224780	1	4222 71	236020	1
	70 KA	DPX ³ 250	100	4206 05	39400	1	4206 15	43490
160			4206 07	49220	1	4206 17	61200	1
200			4206 08	60610	1	4206 18	74580	1
250			4206 09	64420	1	4206 19	77640	1
DPX ³ 630		320	4220 29	65260	1	4220 34	80820	1
		400	4220 30	65270	1	4220 35	80820	1
		500	4220 31	76200	1	4220 36	98180	1
		630	4220 32	80090	1	4220 37	106140	1
DPX ³ 1600		800	4222 76	148620	1	4222 81	186260	1
		1000	4222 77	222840	1	4222 82	315530	1
		1250	4222 78	228300	1	4222 83	393340	1

* MRP - Maximum Retail Price Inclusive of all taxes including GST.
 ■ Price available on request.

Bold Cat.Nos are products normally available with Legrand (India) Stockists. Cat.Nos that are not bold - delivery within 4 - 8 weeks from the date of order. Bold packing quantity is our mandatory packing. Orders to be placed by Legrand (India) Stockist in multiples of the same.

DPX³ MCCB

DPX³ MCCB with Thermal Magnetic Protection Unit

Category	Type	Rated Current (A)	3P			4P		
			Cat.Nos	MRP*/₹/Unit	Pack	Cat.Nos	MRP*/₹/Unit	Pack
Thermal Magnetic + Electronic Earth Leakage Module								
16 KA	DPX ³ 160	16	-	-	-	4200 30	41830	1
		25	-	-	-	4200 31	41830	1
		40	-	-	-	4200 32	41830	1
		63	-	-	-	4200 33	41830	1
		80	-	-	-	4200 34	41830	1
		100	-	-	-	4200 35	41830	1
		125	-	-	-	4200 36	44110	1
		160	-	-	-	4200 37	55970	1
25 KA	DPX ³ 160	16	-	-	-	4200 70	52950	1
		25	-	-	-	4200 71	52950	1
		40	-	-	-	4200 72	52950	1
		63	-	-	-	4200 73	52950	1
		80	-	-	-	4200 74	52950	1
		100	-	-	-	4200 75	52950	1
		125	-	-	-	4200 76	52970	1
		160	-	-	-	4200 77	62540	1
	DPX ³ 250	100	-	-	-	4202 25	63840	1
		160	-	-	-	4202 27	67100	1
		200	-	-	-	4202 28	69700	1
		250	-	-	-	4202 29	74540	1
36 KA	DPX ³ 160	16	-	-	-	4201 10	64410	1
		25	-	-	-	4201 11	64410	1
		40	-	-	-	4201 12	64410	1
		63	-	-	-	4201 13	64410	1
		80	-	-	-	4201 14	64410	1
		100	-	-	-	4201 15	64410	1
		125	-	-	-	4201 16	64760	1
		160	-	-	-	4201 17	77030	1
	DPX ³ 250	100	-	-	-	4202 55	66640	1
		160	-	-	-	4202 57	77630	1
		200	-	-	-	4202 58	81410	1
		250	-	-	-	4202 59	87060	1
50 KA	DPX ³ 160	16	-	-	-	4201 50	74590	1
		25	-	-	-	4201 51	74590	1
		40	-	-	-	4201 52	74590	1
		63	-	-	-	4201 53	74590	1
		80	-	-	-	4201 54	74590	1
		100	-	-	-	4201 55	74590	1
		125	-	-	-	4201 56	79470	1
		160	-	-	-	4201 57	85040	1
	DPX ³ 250	100	-	-	-	4202 85	79960	1
		160	-	-	-	4202 87	92560	1
		200	-	-	-	4202 88	97530	1
		250	-	-	-	4202 89	103630	1

■ Price available on request.

* MRP - Maximum Retail Price Inclusive of all taxes including GST.

Bold Cat.Nos are products normally available with Legrand (India) Stockists. Cat.Nos that are not bold - delivery within 4 - 8 weeks from the date of order. Bold packing quantity is our mandatory packing. Orders to be placed by Legrand (India) Stockist in multiples of the same.

DPX³ MCCB

DPX³ MCCB with Electronic S2* (LSI)* Protection Pnit

- Range: 40A – 1600A, Ics=100%Icu, Three Optimum Frames
- Protection against overloads:
 - Ir adjustable from 0.4 to 1 x In
 - tr adjustable from 3 to 30s#
- Protection against short circuits:
 - Isd adjustable from 1.5 to 10 x Ir
 - tsd adjustable from 0 to 0.5s
- Inbuilt Instantaneous Protection:
 - li# – Fixed
- Option for In built or add on module for Earth Leakage Protection##
 - Adjustable sensitivity: 0.03 - 0.3 - 1 - 3 A
 - Adjustable tripping: 0 - 0.3 - 1 - 3s
- Breaking Capacity# – 25kA, 36kA, 50kA, 70kA & 100kA
- In built Display for Current Metering with accuracy of class 1
- Internal Battery with battery measure function
- Communication Ready via COMM Port
- Logical Selectivity Ready (Zone Selective Interlocking)
- Dynamic Selectivity as per Selectivity Charts
- In Built USB Port for Software Diagnosis
- Suitable for Isolation

Category	Type	Rated Current (A)	3P			4P		
			Cat.Nos	MRP*/₹/Unit	Pack	Cat.Nos	MRP*/₹/Unit	Pack

Electronic S2

25 KA	DPX ³ 250	40	4203 02	31420	1	4203 12	41260	1
		100	4203 05	31420	1	4203 15	41260	1
		160	4203 07	40700	1	4203 17	48680	1
		250	4203 09	53080	1	4203 19	65810	1
36 KA	DPX ³ 250	40	4203 32	35290	1	4203 42	43500	1
		100	4203 35	35290	1	4203 45	43500	1
		160	4203 37	44230	1	4203 47	59010	1
		250	4203 39	59260	1	4203 49	68190	1
	DPX ³ 630	320	4220 57	■	1	4220 62	■	1
		400	4220 58	■	1	4220 63	■	1
		500	4220 59	■	1	4220 64	■	1
		630	4220 60	■	1	4220 65	■	1
DPX ³ 1600	800	4223 00	■	1	4223 06	■	1	
	1000	4223 01	■	1	4223 07	■	1	
	1250	4223 02	■	1	4223 08	■	1	
	1600	4223 03	■	1	4223 09	■	1	
50 KA	DPX ³ 250	40	4203 62	41960	1	4203 72	55910	1
		100	4203 65	41960	1	4203 75	55910	1
		160	4203 67	50650	1	4203 77	60490	1
		250	4203 69	67590	1	4203 79	81820	1
	DPX ³ 630	320	4220 67	■	1	4220 72	■	1
		400	4220 68	■	1	4220 73	■	1
		500	4220 69	■	1	4220 74	■	1
		630	4220 70	■	1	4220 75	■	1
	DPX ³ 1600	800	4223 12	■	1	4223 18	■	1
		1000	4223 13	■	1	4223 19	■	1
		1250	4223 14	■	1	4223 20	■	1
		1600	4223 15	■	1	4223 21	■	1

* MRP - Maximum Retail Price Inclusive of all taxes including GST.
 ■ Price available on request.

Bold Cat.Nos are products normally available with Legrand (India) Stockists. Cat.Nos that are not bold - delivery within 4 - 8 weeks from the date of order. Bold packing quantity is our mandatory packing. Orders to be placed by Legrand (India) Stockist in multiples of the same.

DPX³ MCCB

DPX³ MCCB with Electronic S2[#] (LSI)[#] Protection Unit

Category	Type	Rated Current (A)	3P			4P		
			Cat.Nos	MRP*/₹/Unit	Pack	Cat.Nos	MRP*/₹/Unit	Pack

Electronic S2

70 KA	DPX ³ 250	40	4206 35	51350	1	4206 45	67920	1
		100	4206 37	51860	1	4206 47	67920	1
		160	4206 38	67920	1	4206 48	78020	1
		250	4206 39	77540	1	4206 49	100080	1
	DPX ³ 630	320	4220 77	■	1	4220 82	■	1
		400	4220 78	■	1	4220 83	■	1
		500	4220 79	■	1	4220 84	■	1
		630	4220 80	■	1	4220 85	■	1
	DPX ³ 1600	800	4223 24	■	1	4223 30	■	1
		1000	4223 25	■	1	4223 31	■	1
		1250	4223 26	■	1	4223 32	■	1
		1600	4223 27	■	1	4223 33	■	1

Electronic S2 + Electronic Earth Leakage Module

25 kA	DPX ³ 250	40	-	-	■	4203 22	■	1
		100	-	-	■	4203 25	■	1
		160	-	-	■	4203 27	■	1
		250	-	-	■	4203 29	■	1
36 kA	DPX ³ 250	40	-	-	■	4203 52	■	1
		100	-	-	■	4203 55	■	1
		160	-	-	■	4203 57	■	1
		250	-	-	■	4203 59	■	1
50 kA	DPX ³ 250	40	-	-	■	4203 82	■	1
		100	-	-	■	4203 85	■	1
		160	-	-	■	4203 87	■	1
		250	-	-	■	4203 89	■	1
70 kA	DPX ³ 250	40	-	-	■	4206 55	■	1
		100	-	-	■	4206 57	■	1
		160	-	-	■	4206 58	■	1
		250	-	-	■	4206 59	■	1

■ Price available on request.

* MRP - Maximum Retail Price Inclusive of all taxes including GST.

Bold Cat.Nos are products normally available with Legrand (India) Stockists. Cat.Nos that are not bold - delivery within 4 - 8 weeks from the date of order. Bold packing quantity is our mandatory packing. Orders to be placed by Legrand (India) Stockist in multiples of the same.

DPX³ MCCB

DPX³ MCCB with Electronic Sg (LSIg) Protection Unit

- Range: 40A – 1600A, Ics=100%Icu, Three Optimum Frames
- Protection against Overloads:
 - Ir adjustable from 0.4 to 1 x In
 - tr adjustable from 3 to 30s#
- Protection against Short Circuits:
 - Isd adjustable from 1.5 to 10 x Ir
 - tsd adjustable from 0 to 0.5s
- Inbuilt Instantaneous Protection:
 - li# – Fixed
- Protection against Ground Fault:
 - Ig adjustable from 0.2 to 1 In & OFF
 - tg adjustable from 0.1 to 1s
- Breaking Capacity#– 25kA, 36kA, 50kA, 70kA & 100kA
- In built Display for Current Metering with high accuracy of class 1
- Internal Battery with battery measure function
- Communication Ready via COMM Port
- Logical Selectivity Ready (Zone Selective Interlocking)
- Dynamic Selectivity as per Selectivity Charts
- In Built USB Port for Software Diagnosis
- Switchable Thermal Memory
- Suitable for Isolation

Category	Type	Rated Current (A)	3P			4P		
			Cat.Nos	MRP*/₹/Unit	Pack	Cat.Nos	MRP*/₹/Unit	Pack

Electronic Sg

25 KA	DPX ³ 250	40	4205 02	58370	1	4205 12	65350	1
		100	4205 05	58370	1	4205 15	65350	1
		160	4205 07	64950	1	4205 17	72010	1
		250	4205 09	71800	1	4205 19	84020	1
36 KA	DPX ³ 250	40	4205 22	61810	1	4205 32	69650	1
		100	4205 25	61810	1	4205 35	69650	1
		160	4205 27	68260	1	4205 37	72390	1
		250	4205 29	70100	1	4205 39	74240	1
	DPX ³ 630	320	4221 37	■	1	4221 42	■	1
		400	4221 38	■	1	4221 43	■	1
		500	4221 39	■	1	4221 44	■	1
		630	4221 40	■	1	4221 45	■	1
DPX ³ 1600	800	4223 96	■	1	4224 02	■	1	
	1000	4223 97	■	1	4224 03	■	1	
	1250	4223 98	■	1	4224 04	■	1	
	1600	4223 99	■	1	4224 05	■	1	
50 KA	DPX ³ 250	40	4205 42	63660	1	4205 52	70370	1
		100	4205 45	63660	1	4205 55	70370	1
		160	4205 47	70070	1	4205 57	76640	1
		250	4205 49	71900	1	4205 59	89800	1
	DPX ³ 630	320	4221 47	■	1	4221 52	■	1
		400	4221 48	■	1	4221 53	■	1
		500	4221 49	■	1	4221 54	■	1
		630	4221 50	■	1	4221 55	■	1
	DPX ³ 1600	800	4224 08	■	1	4224 14	■	1
		1000	4224 09	■	1	4224 15	■	1
		1250	4224 10	■	1	4224 16	■	1
		1600	4224 11	■	1	4224 17	■	1

* MRP - Maximum Retail Price Inclusive of all taxes including GST.
 ■ Price available on request.

Bold Cat.Nos are products normally available with Legrand (India) Stockists. Cat.Nos that are not bold - delivery within 4 - 8 weeks from the date of order. Bold packing quantity is our mandatory packing. Orders to be placed by Legrand (India) Stockist in multiples of the same.

DPX³ MCCB

DPX³ MCCB with Electronic Sg (LSIg) Protection Unit

Category	Type	Rated Current (A)	3P			4P		
			Cat.Nos	MRP*/₹/Unit	Pack	Cat.Nos	MRP*/₹/Unit	Pack
Electronic Sg								
70 kA	DPX ³ 250	40	4206 92	66910	1	4207 02	75840	1
		100	4206 95	66910	1	4207 05	75840	1
		160	4206 97	78230	1	4207 07	87460	1
		250	4206 99	80120	1	4207 09	92060	1
	DPX ³ 630	320	4221 57	■	1	4221 62	■	1
		400	4221 58	■	1	4221 63	■	1
		500	4221 59	■	1	4221 64	■	1
		630	4221 60	■	1	4221 65	■	1
	DPX ³ 1600	800	4224 20	■	1	4224 26	■	1
		1000	4224 21	■	1	4224 27	■	1
		1250	4224 22	■	1	4224 28	■	1
		1600	4224 23	■	1	4224 29	■	1

DPX³ MCCB

DPX³ MCCB with Electronic S2[#] (LSI)[#] & Energy Metering Protection Unit

- Range: 40A – 1600A, Ics=100%Icu, Three Optimum Frames
- Protection against overloads:
 - Ir adjustable from 0.4 to 1 x In
 - tr adjustable from 3 to 30s#
- Protection against short circuits:
 - Isd adjustable from 1.5 to 10 x Ir
 - tsd adjustable from 0 to 0.5s
- Inbuilt Instantaneous Protection:
 - li# – Fixed
- Option for In built or add on module for Earth Leakage Protection##
 - Adjustable sensitivity: 0.03 - 0.3 - 1 - 3 A
 - Adjustable tripping: 0 - 0.3 - 1 - 3s
- Breaking Capacity# – 25kA, 36kA, 50kA, 70kA & 100kA
- Integrated energy metering with accuracy class 2
- Measure for currents, voltage, frequency, power, energy and harmonics
- Internal Battery with battery measure function
- Communication Ready via COMM Port
- Logical Selectivity Ready (Zone Selective Interlocking)
- Dynamic Selectivity as per Selectivity Charts
- In Built USB Port for Software Diagnosis
- Suitable for Isolation

Category	Type	Rated Current (A)	3P			4P		
			Cat.Nos	MRP*/₹/Unit	Pack	Cat.Nos	MRP*/₹/Unit	Pack

Electronic S2 + Energy Metering

25 KA	DPX ³ 250	40	4204 02	62990	1	4204 12	72110	1
		100	4204 05	62990	1	4204 15	72130	1
		160	4204 07	68300	1	4204 17	78180	1
		250	4204 09	73950	1	4204 19	84320	1
36 kA	DPX ³ 250	40	4204 32	67370	1	4204 42	73170	1
		100	4204 35	67370	1	4204 45	73170	1
		160	4204 37	73460	1	4204 47	82110	1
		250	4204 39	79370	1	4204 49	92390	1
	DPX ³ 630	320	4220 97	■	1	4221 02	■	1
		400	4220 98	■	1	4221 03	■	1
		500	4220 99	■	1	4221 04	■	1
		630	4221 00	■	1	4221 05	■	1

■ Price available on request.

* MRP - Maximum Retail Price Inclusive of all taxes including GST.

Bold Cat.Nos are products normally available with Legrand (India) Stockists. Cat.Nos that are not bold - delivery within 4 - 8 weeks from the date of order. Bold packing quantity is our mandatory packing. Orders to be placed by Legrand (India) Stockist in multiples of the same.

DPX³ MCCB
DPX³ MCCB with Electronic S2[#] (LSI)[#] & Energy Metering Protection Unit

Category	Type	Rated Current (A)	3P			4P		
			Cat.Nos	MRP*/₹/Unit	Pack	Cat.Nos	MRP*/₹/Unit	Pack

Electronic S2 + Energy Metering

36 KA	DPX ³ 1600	800	4223 48	■	1	4223 54	■	1
		1000	4223 49	■	1	4223 55	■	1
		1250	4223 50	■	1	4223 56	■	1
		1600	4223 51	■	1	4223 57	■	1
50 KA	DPX ³ 250	40	4204 62	75880	1	4204 72	82150	1
		100	4204 65	75880	1	4204 75	82150	1
		160	4204 67	83350	1	4204 77	90320	1
		250	4204 69	88130	1	4204 79	101770	1
	DPX ³ 630	320	4221 07	■	1	4221 12	■	1
		400	4221 08	■	1	4221 13	■	1
		500	4221 09	■	1	4221 14	■	1
		630	4221 10	■	1	4221 15	■	1
DPX ³ 1600	800	4223 60	■	1	4223 66	■	1	
	1000	4223 61	■	1	4223 67	■	1	
	1250	4223 62	■	1	4223 68	■	1	
	1600	4223 63	■	1	4223 69	■	1	
70 KA	DPX ³ 250	40	4206 65	79690	1	4206 75	88200	1
		100	4206 67	79690	1	4206 77	88200	1
		160	4206 68	95260	1	4206 78	101180	1
		250	4206 69	95430	1	4206 79	138780	1
	DPX ³ 630	320	4221 17	■	1	4221 22	■	1
		400	4221 18	■	1	4221 23	■	1
		500	4221 19	■	1	4221 24	■	1
		630	4221 20	■	1	4221 25	■	1
DPX ³ 1600	800	4223 72	■	1	4223 78	■	1	
	1000	4223 73	■	1	4223 79	■	1	
	1250	4223 74	■	1	4223 80	■	1	
	1600	4223 75	■	1	4223 81	■	1	

Electronic S2 + Energy Metering + Electronic Earth Leakage Module

25 KA	DPX ³ 250	40	■	■	■	4204 22	135710	1
		100	■	■	■	4204 25	136360	1
		160	■	■	■	4204 27	144990	1
		250	■	■	■	4204 29	163310	1
36 KA	DPX ³ 250	40	■	■	■	4204 52	137450	1
		100	■	■	■	4204 55	137630	1
		160	■	■	■	4204 57	146160	1
		250	■	■	■	4204 59	163880	1
50 KA	DPX ³ 250	40	■	■	■	4204 82	142840	1
		100	■	■	■	4204 85	144040	1
		160	■	■	■	4204 87	153300	1
		250	■	■	■	4204 89	172410	1
70 KA	DPX ³ 250	40	■	■	■	4206 85	143880	1
		100	■	■	■	4206 87	145190	1
		160	■	■	■	4206 88	153770	1
		250	■	■	■	4206 89	183050	1

* MRP - Maximum Retail Price Inclusive of all taxes including GST.
 ■ Price available on request.

Bold Cat.Nos are products normally available with Legrand (India) Stockists. Cat.Nos that are not bold - delivery within 4 - 8 weeks from the date of order. Bold packing quantity is our mandatory packing. Orders to be placed by Legrand (India) Stockist in multiples of the same.

DPX³ MCCB

DPX³ MCCB with Electronic Sg (LSIg) & Energy Metering Protection Unit

- Range: 250A – 1600A, Ics=100%Icu, Two Optimum Frames
- Protection against Overloads:
 - Ir adjustable from 0.4 to 1 x In
 - tr adjustable from 3 to 30s
- Protection against Short Circuits:
 - Isd adjustable from 1.5 to 10 x Ir
 - tsd adjustable from 0 to 0.5s
- Inbuilt Instantaneous Protection:
 - li – Fixed
- Protection against Ground Fault:
 - Ig adjustable from 0.2 to 1 In & OFF
 - tg adjustable from 0.1 to 1s
- Breaking Capacity – 36kA, 50kA, 70kA & 100kA
- Integrated energy metering with accuracy class 2
- Measure for currents, voltage, frequency, power, energy and harmonics
- Internal Battery with battery measure function
- Communication Ready via COMM Port
- Logical Selectivity Ready (Zone Selective Interlocking)
- Dynamic Selectivity as per Selectivity Charts
- In Built USB Port for Software Diagnosis
- Switchable Thermal Memory
- Suitable for Isolation

Category	Type	Rated Current (A)	3P			4P		
			Cat.Nos	MRP*/₹/Unit	Pack	Cat.Nos	MRP*/₹/Unit	Pack

Electronic Sg + Energy Metering

36 KA	DPX ³ 630	320	4221 77	■	1	4221 82	■	1
		400	4221 78	■	1	4221 83	■	1
		500	4221 79	■	1	4221 84	■	1
		630	4221 80	■	1	4221 85	■	1
	DPX ³ 1600	800	4224 44	■	1	4224 50	■	1
		1000	4224 45	■	1	4224 51	■	1
		1250	4224 46	■	1	4224 52	■	1
		1600	4224 47	■	1	4224 53	■	1
50 KA	DPX ³ 630	320	4221 87	■	1	4221 92	■	1
		400	4221 88	■	1	4221 93	■	1
		500	4221 89	■	1	4221 94	■	1
		630	4221 90	■	1	4221 95	■	1
	DPX ³ 1600	800	4224 56	■	1	4224 62	■	1
		1000	4224 57	■	1	4224 63	■	1
		1250	4224 58	■	1	4224 64	■	1
		1600	4224 59	■	1	4224 65	■	1
70 KA	DPX ³ 630	320	4221 97	■	1	4222 02	■	1
		400	4221 98	■	1	4222 03	■	1
		500	4221 99	■	1	4222 04	■	1
		630	4222 00	■	1	4222 05	■	1
	DPX ³ 1600	800	4224 68	■	1	4224 74	■	1
		1000	4224 69	■	1	4224 75	■	1
		1250	4224 70	■	1	4224 76	■	1
		1600	4224 71	■	1	4224 77	■	1

Switch Disconnector

DPX ³ 160	160	4201 98	12980	1	4201 99	16310	1
	250	4202 99	25340	1	4203 00	34850	1
DPX ³ 630	400	4222 16	36540	1	4222 18	46700	1
	630	4222 17	42250	1	4222 19	58580	1
DPX ³ 1600	800	4224 91	■	1	4224 95	■	1
	1250	4224 92	■	1	4224 96	■	1
	1600	4224 93	■	1	4224 97	■	1

■ Price available on request.

* MRP - Maximum Retail Price Inclusive of all taxes including GST.

Bold Cat.Nos are products normally available with Legrand (India) Stockists. Cat.Nos that are not bold - delivery within 4 - 8 weeks from the date of order. Bold packing quantity is our mandatory packing. Orders to be placed by Legrand (India) Stockist in multiples of the same.

DPX³ MCCB

Category	Type	Rated Current (A)	3P			4P		
			Cat.Nos	MRP*/₹/Unit	Pack	Cat.Nos	MRP*/₹/Unit	Pack

Only Magnetic

16 KA	DPX ³ 160	16	4207 10	18800	1	■	■	■
		25	4207 11	18800	1	■	■	■
		50	4207 12	18800	1	■	■	■
		63	4207 13	18800	1	■	■	■
25 KA	DPX ³ 160	16	4207 14	21380	1	■	■	■
		25	4207 15	21380	1	■	■	■
		50	4207 16	21380	1	■	■	■
		63	4207 17	21380	1	■	■	■
36 KA	DPX ³ 250	100	4207 18	37160	1	■	■	■
		160	4207 19	37160	1	■	■	■
		200	4207 20	39300	1	■	■	■
		250	4207 21	41420	1	■	■	■
70 KA	DPX ³ 250	100	4207 22	36320	1	■	■	■
		160	4207 23	36320	1	■	■	■
		200	4207 24	38590	1	■	■	■
		250	4207 25	40860	1	■	■	■

Accessories

Type	Rotary handle				Shunt release											
	Direct		Vary depth		12 V		24 V		48 V		110 V		230 V		400 V	
	Cat.No	MRP	Cat.No	MRP	Cat.No	MRP	Cat.No	MRP	Cat.No	MRP	Cat.No	MRP	Cat.No	MRP	Cat.No	MRP
DPX ³ 160 DPX ³ 250	4201 60	1850	4201 61	2680	4210 12	3600	4210 13	3600	4210 14	3600	4210 15	3600	4210 16	3600	4210 17	3600
DPX ³ 630	4201 62	2960	4201 63	5090												
DPX ³ 1600	0262 61	6200	0262 83	9520	-	-	4222 39	3830	4222 40	3570	4222 41	3570	4222 42	3830	4222 43	3830

Type	U/V release													
	12 V		24 V		48 V		110 V		230 V		400 V		480 V	
	Cat.No	MRP	Cat.No	MRP	Cat.No	MRP	Cat.No	MRP	Cat.No	MRP	Cat.No	MRP	Cat.No	MRP
DPX ³ 160 DPX ³ 250	4210 18	4510	4210 19	4510	4210 20	4510	4210 21	4460	4210 22	4460	4210 24	4460	4210 25	4460
DPX ³ 630 DPX ³ 1600	-	-	4222 45	5060	4222 46	5060	4222 47	5020	4222 48	5380	4222 49	5380	-	-

Type	Rated Current (A)	Spreaders**				Motor Operator									
		3P (Set of 3)		4P (Set of 4)		24-230V Side		24V		48V		110V		230V	
		Cat.No	MRP	Cat.No	MRP	Cat.No	MRP	Cat.No	MRP	Cat.No	MRP	Cat.No	MRP	Cat.No	MRP
DPX ³ 160		6250 02	1020	6250 06	1380										
DPX ³ 250		6250 14	1020	6250 18	1380	4210 60	50880	4210 61	45700	4210 61	45700	4210 61	45700	4210 61	45700
DPX ³ 630	Upto 400 A	4226 31	2060	4226 32	2750										
	630 A	6250 04	2450	6250 08	3140	-	-	0261 40	78130	0261 41	78130	-	-	0261 44	74410
DPX ³ 1600	Upto 1250 A	4226 24	14710	4226 25	17870	-	-	0261 24	■	0261 25	■	0261 26	79700	0261 23	86160
	1600 A	0262 73	38340	0262 74	40440	-	-	0261 19	■	0261 28	■	0261 29	■	0261 27	81180

* MRP - Maximum Retail Price Inclusive of all taxes including GST.
 ■ Price available on request.

Bold Cat.Nos are products normally available with Legrand (India) Stockists.
 Cat.Nos that are not bold - delivery within 4 - 8 weeks from the date of order.
 Bold packing quantity is our mandatory packing. Orders to be placed by Legrand (India) Stockist in multiples of the same.

DPX³ 160

Equipment & Mounting Accessories

Cat.Nos	Description	MRP* ₹ / Unit	Pack
---------	-------------	------------------	------

Equipment for Plug-in Version

4210 40	For DPX ³ 160 - 3P	30520	1
4210 41	For DPX ³ 160 - 4P	40910	1
4210 44	Set of connectors for auxiliary contacts	4370	1
4210 45	Key barrel and flat key for Padlocks	27860	1
4210 46	Key barrel and star key for Padlocks	25220	1
4210 47	Padlock accessory	7740	1

Connection Accessories

4210 26	Set of 3 terminals for High capacity cage terminals	11620	1
4210 27	Set of 4 terminals for High capacity cage terminals	15350	1
4210 70	Set of 3 Insulated Shields/ Phase barriers	250	1
4210 28	Set of 3 terminals Screw terminals for copper bars connection	1320	1
4210 29	Set of 4 terminals Screw terminals for copper bars connection	1370	1
6250 02	Set of 3 spreaders for DPX ³ 160 3P	1020	1
6250 06	Set of 4 spreaders for DPX ³ 160 4P	1380	1

Connection Accessories

4210 36	Set of 3 rear terminals for DPX ³ 160 3P	6220	1
4210 37	Set of 4 rear terminals for DPX ³ 160 4P	8330	1

Sealable terminal shields

For Front Terminals

4210 54	For DPX ³ 160 3P	6790	1
4210 55	For DPX ³ 160 3P	7150	1

For Rear Terminals

4210 50	For DPX ³ 160 3P	4280	1
4210 51	For DPX ³ 160 4P	3800	1

Fixing Plates

4210 71	For DPX ³ 160 3P / 4P without earth leakage module	620	1
4210 73	For DPX ³ 160 4P with earth leakage module	1540	1
4210 68	For DPX ³ 160 3P / 4P with side mounting motor operator	1570	1

■ Price available on request.

* MRP - Maximum Retail Price Inclusive of all taxes including GST.



4210 40



4210 36



4210 58



4210 10



4210 11

DPX³ 160 and 250

Common Auxiliaries & Accessories

Cat.Nos	Description	MRP* ₹ / Unit	Pack
---------	-------------	------------------	------

Supply Inverter Type

4210 58	For fixed version	5720	1
4210 59	For plug-in and draw-out version	6100	1

Rotary Handles

4201 60	Standard handle for thermal magnetic DPX ³	1850	1
4201 61	Vari-depth standard handles	2680	1
4201 67	Key Lock for VD RH DPX ³ 160 & 250	3260	1
4201 65	Key Lock for DIR RH Type A DPX ³ 160 & 250	3160	1
4201 68	Key Lock for VD RH Type A DPX ³ 160 & 250	3260	1
4201 66	Key Lock for DIR RH Type B DPX ³ 160 & 250	3160	1
4201 69	Key Lock for VD RH Type B DPX ³ 160 & 250	3260	1

Motor-Driven Handles

4210 60	Side motor operator	50880	1
4210 61	Front motor operator	45700	1
4210 62	Ronis key barrel for front motor operator	10440	1
4210 63	Profalux key barrel for front motor operator	24800	1

DPX³ 160 and 250 common

Auxiliaries & Accessories

4210 64	Padlock for front motor operator	3540	1
4210 65	Ronis key barrel for side motor operator	27540	1
4210 66	Profalux key barrel for side motor operator	25020	1
4210 67	Padlock for side motor operator	3760	1

Auxiliary Contacts

4210 10	1 N/C + 1 N/O auxiliary contact for rotary handles	2080	1
4210 11	Auxiliary contact or fault signalling contact	1620	1
4210 48	Signalling contact plugged-in/drawn-out (for DPX ³ plug-in version)	1740	1

Locking Accessory

4210 49	Padlock for locking in "open" position	28420	1
---------	--	-------	---

Communication Interface

4210 75	Modbus	23510	1
---------	--------	-------	---

Bold Cat.Nos are products normally available with Legrand (India) Stockists. Cat.Nos that are not bold - delivery within 4 - 8 weeks from the date of order. Bold packing quantity is our mandatory packing. Orders to be placed by Legrand (India) Stockist in multiples of the same.

DPX³ 250 Equipment & Mounting Accessories

Cat.Nos	Description	MRP* ₹ / Unit	Pack
---------	-------------	------------------	------

Equipment for Plug-in Version

4210 42	For DPX ³ 250 - 3P	34180	1
4210 43	For DPX ³ 250 - 4P with or without earth leakage module	41170	1
4210 44	Set of connectors for auxiliary contacts	4370	1
4210 45	Key barrel and flat key N° ABA90GEL6149 for Padlocks	27860	1
4210 46	Key barrel and star key N° HBA90GPS6149 for Padlocks	25220	1
4210 47	Padlock accessory	7740	1

Connection Accessories

4210 30	Set of 3 cage terminals	4680	1
4210 31	Set of 4 cage terminals	6100	1
4210 70	Set of 3 phase barriers	250	1

Connection Accessories

6250 14	Set of 3 spreaders for DPX ³ 250 3P	1020	1
6250 18	Set of 4 spreaders for DPX ³ 250 4P	1380	1
4210 38	Set of 3 rear terminals for DPX ³ 250 3P	6280	1
4210 39	Set of 4 rear terminals for DPX ³ 250 4P	8450	1

Sealable Terminal Shields

For Front Terminals

4210 56	For DPX ³ 250 3P	7020	1
4210 57	For DPX ³ 250 4P	7440	1

For Rear Terminals

4210 52	For DPX ³ 250 3P	4190	1
4210 53	For DPX ³ 250 4P	4610	1

Fixing Plates

4210 72	For DPX ³ 250 3P / 4P without earth leakage module	620	1
4210 74	For DPX ³ 250 4P with earth leakage module	2660	1
4210 69	For DPX ³ 250 3P / 4P with side mounting motor operator	1560	1

DPX³ 630 Equipment & Accessories

Plug-in Version

4222 20	Set of incoming and outgoing terminals - 3P (6 terminals for 3P DPX ³ or 8 terminals for 4P DPX ³)	5570	1
---------	---	------	---

DPX³ 630 Equipment & Accessories

Cat.Nos	Description	MRP* ₹ / Unit	Pack
---------	-------------	------------------	------

Plug-in Version

4222 21	Set of incoming and outgoing terminals - 4P (6 terminals for 3P DPX ³ or 8 terminals for 4P DPX ³)	6500	1
4222 22	Front terminal mounting base for DPX ³ only - 3P	12980	1
4222 24	Flat rear terminal mounting base for DPX ³ only - 3P	20220	1
4222 23	Front terminal mounting base for DPX ³ only - 4P	16250	1
4222 25	Flat rear terminal mounting base for DPX ³ only - 4P	40120	1
4222 26	Front terminal mounting base for DPX ³ with earth leakage module - 4 P	■	1
4222 27	Flat rear terminal mounting base for DPX ³ with earth leakage module - 4P	■	1
4222 37	For fixing the signalling contact - 4P Cat.No 0265 74 on a DPX ³ plug-in version	4320	1
4222 28	Set of 2 extractor handle	6060	1
4222 29	Set of connectors (24-pin)	3400	1

Draw-out Version

4222 31	"Debro-lift" mechanism for DPX ³ base only - 3P	39860	1
4222 32	"Debro-lift" mechanism for DPX ³ base only - 4P	41740	1
4222 33	"Debro-lift" mechanism for DPX ³ base with elm - 4P	■	1
0265 76	One key for "Debro-lift" mechanism for DPX ³ only - Flat key	■	1
0265 78	Two keys (one key supplied) for "Debro-lift" mechanism for motorised DPX ³ or with rotary handle - Flat key	■	1
0263 48	One key for "Debro-lift" mechanism for DPX ³ only - Star key	■	1
0265 77	Two keys (one key supplied) for motorised DPX ³ or with rotary handle - Star key	■	1
0265 75	Handle for drawing-out for "Debro-lift" mechanism	6400	1
0265 74	Signalling contact (plugged-in/drawn-out) for "Debro-lift" mechanism	4360	1
4222 36	For fixing the signalling contact Cat.No 0265 74 on a DPX ³ draw-out version	4360	1

■ Price available on request.

* MRP - Maximum Retail Price inclusive of all taxes including GST.

Bold Cat.Nos are products normally available with Legrand (India) Stockists. Cat.Nos that are not bold - delivery within 4 - 8 weeks from the date of order. Bold packing quantity is our mandatory packing. Orders to be placed by Legrand (India) Stockist in multiples of the same.

DPX³ 630 Equipment & Accessories

Cat.Nos	Description	MRP* ₹ / Unit	Pack
---------	-------------	------------------	------

Draw-out Version

4222 30	Block of 6 automatic auxiliary contacts for DPX ³ draw-out version (up to 2 blocks by DPX ³)	1660	1
---------	---	------	---

Supply inverter type

0264 09	Plate for MCCB or trip-free switch fixed version	13930	1
0264 04	Plate for MCCB or trip-free switch plug-in and draw-out version	18800	1

Rotary Handles

4201 62	Direct rotary handle	2960	1
4201 63	Vari-depth rotary handle	5090	1
4201 70	Key Lock for VD RH DPX ³ 630	3540	1
4201 71	Key Lock for VD RH Type A DPX ³ 630	3540	1
4201 72	Key Lock for VD RH Type B DPX ³ 630	3540	1

Motor-Driven Handles

0261 40	Front operated 24 V~/=	78130	1
0261 41	Front operated 48 V~/=	78130	1
0261 44	Front operated 230 V~	74410	1
422806	Lock and flat key	■	1
0261 58	Lock and star key	19980	1

Accessories

0262 30	Set of 3 Insulated Shields/ Phase barriers	310	1
0262 44	Set of 2 sealable terminal shields - 3P	8664	1
0262 45	Set of 2 sealable terminal shields - 4P	2420	1
0262 40	Padlock for locking in "OPEN" position - 4P	3130	1
0262 46	Set of 4 adaptors + Insulated Shields/ Phase barriers for lug - 4P	■	1
0262 47	Set of 4 extended front terminals-4P	8570	1
6250 04	Set of incoming or outgoing spreaders - 3P	2450	1
6250 08	Set of incoming or outgoing spreaders - 4P	3140	1
0263 50	Set of incoming or outgoing swivel rear terminals - 3P	■	1
0263 52	Set of incoming or outgoing flat rear terminals - 3P	27660	1
0263 51	Set of incoming or outgoing swivel terminals - 4P	■	1
0263 53	Set of incoming or outgoing flat terminals - 4P	23490	1
4222 34	Set of 2 IP 20 terminal covers - 3P	1850	1
4222 35	Set of 2 IP 20 terminal covers - 4P	6410	1



0261 40



6250 04



4222 34



4222 35

DPX³ 630 Earth Leakage Module

Type and frame size	Rated Current (A)	Poles	Cat.Nos	MRP* ₹ / Unit	Pack
---------------------	-------------------	-------	---------	------------------	------

Earth Leakage Module Standard

DPX ³ 630	400 A	3 Pole	0260 60	50430	1
	630 A	3 Pole	0260 64	94510	1
	400 A	4 Pole	0260 61	89090	1
	630 A	4 Pole	0260 65	93900	1

LED Version

DPX ³ 630	400 A	4 Pole	0260 63	■	1
	630 A	4 Pole	0260 67	92000	1

DPX³ 1600 Equipment & Accessories

Cat.Nos	Description	MRP* ₹ / Unit	Pack
---------	-------------	------------------	------

Draw-out Version

4225 86	Front terminals - 3P	■	1
4225 88	Rear terminals - 3P	■	1
4225 87	Front terminals - 4P	■	1
4225 89	Rear terminals - 4P	■	1
4225 93	Debro-lift mechanism For DPX ³ 1600 - 3P	■	1
4225 94	Debro-lift mechanism for DPX ³ 1600 - 4P	■	1
4225 95	For fixing the signalling contact Cat.No 0265 74 on a DPX ³ draw-out version	■	1
0265 76	One key for "Debro-lift" mechanism for DPX ³ only - Flat key	■	1
0265 80	Two key (one key supplied) for motorised DPX ³ or with rotary handle	■	1
0263 48	One key for DPX ³ only - Starkey	■	1
0265 79	Two key (one key supplied) for motorised DPX ³ or with rotary handle	■	1
0265 75	Handle for drawing-out for "Debro-lift" mechanism	6400	1
0265 74	Signalling contact (plugged-in/drawn-out)	4360	1
4222 30	Block of 6 automatic auxiliary contacts for DPX ³ draw-out version (up to 2 blocks by DPX ³)	1660	1



4225 88
+
4225 93

■ Price available on request.

* MRP - Maximum Retail Price Inclusive of all taxes including GST.

Bold Cat.Nos are products normally available with Legrand (India) Stockists. Cat.Nos that are not bold - delivery within 4 - 8 weeks from the date of order. Bold packing quantity is our mandatory packing. Orders to be placed by Legrand (India) Stockist in multiples of the same.

DPX³ 1600

Equipment & Accessories

Cat.Nos	Description	MRP* ₹ / Unit	Pack
---------	-------------	------------------	------

Supply Inverter Type

0264 10	Plate for MCCBs or trip-free switch fixed version	16880	1
0264 05	Plate for MCCBs or trip-free switch plug-in and draw-out version	■	1

Rotary Handles

0262 61	Standard (black) direct on DPX ³	6200	1
0262 83	Standard (black) vari-depth handle IP 55	9520	1
0262 93	Key barrel and flat key	3530	1
0262 94	Key barrel and star key	18200	1

Motor-Driven Handles

0261 54	Front operated 230 V±	101280	1
0261 24	Front operated 24 V±/= for In ≤ 1250 A	■	1
0261 25	Front operated 48 V±/= for In ≤ 1250 A	■	1

Motor-Driven Handles

0261 26	Front operated 110 V±/= for In ≤ 1250 A	79700	1
0261 23	Front operated 230 V±/= for In ≤ 1250 A	86160	1
0261 19	Front operated 24 V±/= for In = 1600 A	■	1
0261 28	Front operated 48 V±/= for In = 1600 A	■	1
0261 29	Front operated 110 V±/= for In = 1600 A	■	1
0261 27	Front operated 230 V±/= for In = 1600 A	81180	1
4228 06	Mech Support DPX ³ 630/1600 Key lock	10990	1
0261 58	Key and star key	19980	1

Accessories

0262 66	Set of 3 Insulated Shields/ Phase barriers	600	1
0262 64	Set of 2 sealable terminal shields - 3P	■	1
0262 65	Set of 2 sealable terminal shields - 4P	3250	1
0262 60	Padlock for locking in "open" position	2810	1
0262 67	Set of 4 extended front short terminals for 630 - 1250 A (2 bars max. per pole)	■	1



0262 60

■ Price available on request.

* MRP - Maximum Retail Price Inclusive of all taxes including GST.

DPX³ 630 and 1600

Common Auxiliaries

Cat.Nos	Description	MRP* ₹ / Unit	Pack
---------	-------------	------------------	------

Accessories

0262 68	Set of 4 extended front Long terminals for 1600 A (3 bars max. per pole)	27690	1
4226 24	Set of incoming or outgoing spreaders for 800 A & 1000 A - 3P	14710	1
4226 25	Set of incoming or outgoing spreaders for 800 A & 1000 A - 4P	17870	1
0262 73	Set of incoming or outgoing spreaders for 1250 A & 1600 A - 3P	38340	1
0262 74	Set of incoming or outgoing spreaders for 1250 A & 1600 A - 4P	40440	1
0263 80	Short rear terminals - 3P	■	1
0263 81	Long rear terminals - 3P	■	1
0263 82	Short rear terminals - 4P	■	1
0263 83	Long rear terminals - 4P	■	1
4225 90	Set of 2 IP 20 terminal covers - 3P	2050	1
4225 91	Set of 2 IP 20 terminal covers - 4P	3330	1
4225 92	External neutral - 4P	21750	1



0262 67 + 0262 68

Common Auxiliaries

4210 11	For signalling the state of the contacts or opening of the MCCB on a fault For DPX ³ /DPX ³ -I Changeover switch 3 A - 240 V±	1620	1
---------	---	------	---

Releases

Allow remote tripping of a DPX³

Time-lag undervoltage releases (800 ms)

Prevent false tripping in the event of power supply microbreaks.

Require a time-lag module connected to the undervoltage release Cat.No 4226 23

0261 90	Time-lag module 230 VA 3 module	■	1
---------	---------------------------------	---	---

Bold Cat.Nos are products normally available with Legrand (India) Stockists. Cat.Nos that are not bold - delivery within 4 - 8 weeks from the date of order. Bold packing quantity is our mandatory packing. Orders to be placed by Legrand (India) Stockist in multiples of the same.

DPX³ 630 and 1600

Common Auxiliaries

Cat.Nos	Description	MRP* ₹ / Unit	Pack
---------	-------------	---------------------	------

Releases

0261 91	Time-lag module 400 VA	■	1
4226 23	Undervoltage release for DPX ³ 630 and 1600	■	1

Auto Transfer Controller

4226 81	Standard unit	45720	1
4226 82	Advanced unit	53350	1
4226 89	Communication module	14300	1



4226 82



0260 88

Residual Current Relay

0260 88	Residual current relay to clip on module 2 rail	31960	1
---------	--	-------	---

Current Transformer

0260 92	Coil Ø35 mm	17450	1
0260 93	Coil Ø80 mm	25460	1
0260 94	Coil Ø110 mm	39250	1
0260 95	Coil Ø140 mm	41300	1
0260 96	Coil Ø210 mm	70450	1
0260 97	Coil Ø150 mm - open	■	1
0260 98	Coil Ø300 mm - open	■	1



0260 93
coil for use
with relay



0260 98

Metal One Way Enclosures for MCCB

Cat.Nos	Description	No. of modules	MRP* ₹ / Unit	Pack
---------	-------------	-------------------	---------------------	------

5078 01	DPX ³ 160 MCCB enclosure	3&4	6242	1
5078 02	DPX ³ 250 MCCB enclosure	3&4	10976	1
5078 04	DPX ³ 630 MCCB enclosure	3&4	17050	1

■ Price available on request.

* MRP - Maximum Retail Price Inclusive of all taxes including GST.

DRX

MCCB RANGE

Powerful Protection, Compact Design Engineered for Enduring Safety



The DRX MCCB range delivers dependable circuit protection with a robust design and a wide range of accessories. Engineered for efficiency and affordability, it offers adjustable protection settings and advanced safety features to safeguard electrical installations across industrial and commercial applications up to 630A.

Features

- Accurate performance at higher temperatures with no deration up to 50°C
- Adjustable protection settings with overload and pre-alarm indication
- Integrated contact module for status indication and monitoring
- In-built neutral protection available in 4-pole configuration

Benefits

- Ensures reliable circuit protection even in demanding environments
- Enables flexible configuration for different electrical protection needs
- Improves monitoring and operational visibility of electrical systems
- Provides enhanced safety and protection for electrical installations



A COMPREHENSIVE RANGE

The robust design of DRX MCCB offer adjustable protection, different accessories for connection and remote tripping. They are the ideal choice in terms of efficiency and affordability for protection of your electrical installations of up to 630A.



QCO Certified

Scan to know more about the product.



DRX MCCB

DRX MCCB with Thermal Magnetic Protection Unit

Range – 16A to 630A

Ics = 100% Icu

Thermal Adjustable – 0.8 to 1 In

Magnetic Setting – 10 In for DRX125HP

Magnetic Setting – Adjustable 5 to 10 In for DRX250HP and DRX630

Suitable for Isolation

Category	Type	Rated Current (A)	3P			4P		
			Cat.Nos	MRP*/₹/Unit	Pack	Cat.Nos	MRP*/₹/Unit	Pack

Thermal Magnetic : O/L & S/C Protection

25 KA	DRX 125 ^{HP}	16	6697 00	10260	1	6697 10	14270	1
		20	6697 01	10260	1	6697 11	14270	1
		25	6697 02	10260	1	6697 12	14270	1
		32	6697 03	10260	1	6697 13	14270	1
		40	6697 04	10260	1	6697 14	14270	1
		50	6697 05	10260	1	6697 15	14270	1
		63	6697 06	10260	1	6697 16	14270	1
		80	6697 07	10260	1	6697 17	14270	1
		100	6697 08	10260	1	6697 18	14270	1
		125	6697 09	15200	1	6697 19	18030	1
36 KA	DRX 125 ^{HP}	16	6697 20	13360	1	6697 30	16660	1
		20	6697 21	13360	1	6697 31	16660	1
		25	6697 22	13360	1	6697 32	16660	1
		32	6697 23	13360	1	6697 33	16660	1
		40	6697 24	13360	1	6697 34	16660	1
		50	6697 25	13360	1	6697 35	16660	1
		63	6697 26	13360	1	6697 36	16660	1
		80	6697 27	13360	1	6697 37	16660	1
		100	6697 28	13360	1	6697 38	16660	1
		125	6697 29	15380	1	6697 39	19400	1
50 KA	DRX 125 ^{HP}	16	6697 40	17080	1	6697 50	21520	1
		20	6697 41	17080	1	6697 51	21520	1
		25	6697 42	17080	1	6697 52	21520	1
		32	6697 43	17080	1	6697 53	21520	1
		40	6697 44	17080	1	6697 54	21520	1
		50	6697 45	17080	1	6697 55	21520	1
		63	6697 46	17080	1	6697 56	21520	1
		80	6697 47	17080	1	6697 57	21520	1
		100	6697 48	17080	1	6697 58	21520	1
		125	6697 49	22380	1	6697 59	25780	1

* MRP - Maximum Retail Price Inclusive of all taxes including GST.

Bold Cat.Nos are products normally available with Legrand (India) Stockists. Cat.Nos that are not bold - delivery within 4 - 8 weeks from the date of order. Bold packing quantity is our mandatory packing. Orders to be placed by Legrand (India) Stockist in multiples of the same.

DRX MCCB

DRX MCCB with Thermal Magnetic Protection Unit

Category	Type	Rated Current (A)	3P			4P		
			Cat.Nos	MRP*/₹/Unit	Pack	Cat.Nos	MRP*/₹/Unit	Pack

Thermal Magnetic : O/L & S/C Protection

25 KA	DRX 250 ^{HP}	16	6690 00	■	1	6690 20	■	1	
		20	6690 01	■	1	6690 21	■	1	
		25	6690 02	■	1	6690 22	■	1	
		32	6690 03	■	1	6690 23	■	1	
		40	6690 04	15500	1	6690 24	18890	1	
		50	6690 05	15500	1	6690 25	18890	1	
		63	6690 06	15500	1	6690 26	18890	1	
		80	6690 07	15500	1	6690 27	18890	1	
		100	6690 08	16320	1	6690 28	19830	1	
		125	6690 09	17230	1	6690 29	21310	1	
		160	6690 10	21750	1	6690 30	25230	1	
		200	6690 11	24760	1	6690 31	30350	1	
250	6690 12	28800	1	6690 32	34450	1			
36 KA	DRX 250 ^{HP}	16	6690 40	■	1	6690 60	■	1	
		20	6690 41	■	1	6690 61	■	1	
		25	6690 42	■	1	6690 62	■	1	
		32	6690 43	■	1	6690 63	■	1	
		40	6690 44	15970	1	6690 64	19680	1	
		50	6690 45	15970	1	6690 65	19680	1	
		63	6690 46	15970	1	6690 66	19680	1	
		80	6690 47	15970	1	6690 67	19680	1	
		100	6690 48	16770	1	6690 68	20640	1	
		125	6690 49	18830	1	6690 69	22090	1	
		160	6690 50	21980	1	6690 70	25560	1	
		200	6690 51	27200	1	6690 71	35130	1	
	250	6690 52	31140	1	6690 72	37520	1		
		DRX 630	320	6676 50	38380	1	6676 54	46740	1
			400	6676 51	38380	1	6676 55	47610	1
			500	6676 52	49470	1	6676 56	62260	1
	630		6676 53	49470	1	6676 57	65230	1	



6676 51

■ Price available on request.

* MRP - Maximum Retail Price Inclusive of all taxes including GST.

Bold Cat.Nos are products normally available with Legrand (India) Stockists. Cat.Nos that are not bold - delivery within 4 - 8 weeks from the date of order. Bold packing quantity is our mandatory packing. Orders to be placed by Legrand (India) Stockist in multiples of the same.

DRX MCCB

DRX MCCB with Thermal Magnetic Protection Unit

Category	Type	Rated Current (A)	3P			4P		
			Cat.Nos	MRP*/₹/Unit	Pack	Cat.Nos	MRP*/₹/Unit	Pack

Thermal Magnetic : O/L & S/C Protection

50 KA	DRX 250 ^{HP}	16	6690 80	■	1	6691 00	■	1
		20	6690 81	■	1	6691 01	■	1
		25	6690 82	■	1	6691 02	■	1
		32	6690 83	■	1	6691 03	■	1
		40	6690 84	22540	1	6691 04	27090	1
		50	6690 85	22540	1	6691 05	27120	1
		63	6690 86	22540	1	6691 06	27120	1
		80	6690 87	22540	1	6691 07	27120	1
		100	6690 88	23670	1	6691 08	28470	1
		125	6690 89	24550	1	6691 09	29560	1
		160	6690 90	27430	1	6691 10	31950	1
		200	6690 91	33170	1	6691 11	41270	1
		250	6690 92	35660	1	6691 12	43920	1
		50 KA	DRX 630	320	6676 58	42250	1	6676 62
400	6676 59			42250	1	6676 63	53140	1
500	6676 60			59850	1	6676 64	74770	1
630	6676 61			59850	1	6676 65	74770	1



6690 92



6676 61

DRX MCCB

DRX MCCB with Electronic S2 (LSI) Protection Unit

- Range: 40A – 630A, Ics=100%Icu, Two Optimum Frames
- Protection against overloads:
 - Ir adjustable from 0.4 to 1 x In
 - tr adjustable from 3 to 30s#
- Protection against short circuits:
 - I_{sd} adjustable from 1.5 to 10 x Ir
 - t_{sd} adjustable from 0 to 0.5s
- Inbuilt Instantaneous Protection:
 - I_{i#} – Fixed
- Overload Alarm Indication - I > 1.05 Ir
- Pre-Overload Alarm Indication - I > 0.9 Ir
- Over temperature Alarm Indication - T > 90 °C
- Integrated Contact Module (On/Off/ Trip) for DRX 250HP Electronic MCCBs
- Suitable for Isolation

Category	Type	Rated Current (A)	3P			4P		
			Cat.Nos	MRP*/₹/Unit	Pack	Cat.Nos	MRP*/₹/Unit	Pack

Electronic S2

36 KA	DRX 250 ^{HP}	40	6691 70	23550	1	6691 80	29930	1	
		100	6691 71	23550	1	6691 81	29930	1	
		160	6691 72	30140	1	6691 82	42160	1	
		250	6691 73	41370	1	6691 83	56450	1	
	36 KA	DRX 630	320	6699 01	53390	1	6699 06	65760	1
			400	6699 02	53390	1	6699 07	65760	1
			630	6699 04	59960	1	6699 09	78530	1

* MRP - Maximum Retail Price Inclusive of all taxes including GST.
 ■ Price available on request.

Bold Cat.Nos are products normally available with Legrand (India) Stockists. Cat.Nos that are not bold - delivery within 4 - 8 weeks from the date of order. Bold packing quantity is our mandatory packing. Orders to be placed by Legrand (India) Stockist in multiples of the same.

DRX MCCB

DRX MCCB with Electronic S2 (LSI) Protection Unit

Electronic S2

50 KA	DRX 250 ^{HP}	40	6691 90	28380	1	6692 00	39190	1
		100	6691 91	28380	1	6692 01	39190	1
		160	6691 92	36870	1	6692 02	48320	1
		250	6691 93	47060	1	6692 03	60280	1
	DRX 630	320	6699 11	58410	1	6699 16	74470	1
		400	6699 12	58410	1	6699 17	74470	1
630		6699 14	64800	1	6699 19	82970	1	

DRX MCCB

DRX MCCB with Electronic Sg (LSIg) Protection Unit

- Range: 40A – 630A, Ics=100%Icu, Two Optimum Frames
- Protection against overloads:
 - Ir adjustable from 0.4 to 1 x In
 - tr adjustable from 3 to 30s#
- Protection against short circuits:
 - I_{sd} adjustable from 1.5 to 10 x Ir
 - t_{sd} adjustable from 0 to 0.5s
- Inbuilt Instantaneous Protection:
 - Ii# – Fixed
- Protection against Ground Fault:
 - Ig adjustable from 0.2 to 1 In & OFF
 - tg adjustable from 0.1 to 1s
- Overload Alarm Indication - I > 1.05 Ir
- Pre-Overload Alarm Indication - I > 0.9 Ir
- Over temperature Alarm Indication - T > 90 °C
- Integrated Contact Module (On/Off/ Trip) for DRX 250HP Electronic MCCBs
- Suitable for Isolation

Category	Type	Rated Current (A)	3P			4P		
			Cat.Nos	MRP*/₹/Unit	Pack	Cat.Nos	MRP*/₹/Unit	Pack

Electronic Sg

36 KA	DRX 250 ^{HP}	40	6691 75	42600	1	6691 85	49520	1
		100	6691 76	42600	1	6691 86	49520	1
		160	6691 77	48530	1	6691 87	59420	1
		250	6691 78	57450	1	6691 88	71300	1
	DRX 630	320	6699 21	72500	1	6699 26	83420	1
		400	6699 22	72500	1	6699 27	83420	1
630		6699 24	78450	1	6699 29	97040	1	
50 KA	DRX 250 ^{HP}	40	6691 95	46550	1	6692 05	55200	1
		100	6691 96	46550	1	6692 06	55200	1
		160	6691 97	55460	1	6692 07	65860	1
		250	6691 98	62400	1	6692 08	73610	1
	DRX 630	320	6699 31	75030	1	6699 36	90540	1
		400	6699 32	75030	1	6699 37	90540	1
630		6699 34	80980	1	6699 39	101000	1	



6691 98

* MRP - Maximum Retail Price Inclusive of all taxes including GST.

Bold Cat.Nos are products normally available with Legrand (India) Stockists. Cat.Nos that are not bold - delivery within 4 - 8 weeks from the date of order. Bold packing quantity is our mandatory packing. Orders to be placed by Legrand (India) Stockist in multiples of the same.

Accessories

Type	Rotary handle					
	Direct			Vary depth		
	Cat.No	MRP	Pack	Cat.No	MRP	Pack
DRX 125HP	6687 70	1530	1	6687 71	2330	1
DRX 250HP	6687 72	1550	1	6687 73	2420	1
DRX 630	6687 80	2750	1	6687 81	4530	1



0271 54



4222 42

Type	Shunt release					
	240V AC			415V AC		
	Cat.No	MRP	Pack	Cat.No	MRP	Pack
DRX 125HP	0271 54	2880	1	0271 55	2880	1
DRX 250HP						
DRX 630	4222 42	■	1	4222 43	■	1



0271 65

Type	Undervoltage					
	240V AC			415V AC		
	Cat.No	MRP	Pack	Cat.No	MRP	Pack
DRX 125HP	0271 64	3990	1	0271 65	3990	1
DRX 250HP						
DRX 630	4222 48	■	1	4222 49	■	1

Type	Rated Current (A)	Spreaders					
		3P One Side			4P One Side		
		Cat.No	MRP	Pack	Cat.No	MRP	Pack
DRX 125HP	125A	6250 10	330	1	6250 11	480	1
DRX 250HP	250A	6250 14	1020	1	6250 18	1380	1
DRX 630	400A	4226 31	2060	1	4226 32	2750	1
	630A	6250 04	2450	1	6250 08	3140	1

Type	Rated Current (A)	Phase Barriers					
		3P One Side			4P One Side		
		Cat.No	MRP	Pack	Cat.No	MRP	Pack
DRX 125HP	125A	6693 00	210	1	6693 01	260	1
DRX 250HP	250A						
DRX 630	400A	0262 30	310	1	0262 30	310	1
	630A						

* MRP - Maximum Retail Price Inclusive of all taxes including GST.
 ■ Price available on request.

Bold Cat.Nos are products normally available with Legrand (India) Stockists.
 Cat.Nos that are not bold - delivery within 4 - 8 weeks from the date of order.
 Bold packing quantity is our mandatory packing. Orders to be placed by Legrand (India) Stockist in multiples of the same.

Accessories



0271 80

Type	Rated Current (A)	Padlocks		
		3P One Side		
		Cat.No	MRP	Pack
DRX 125HP	125A	0271 80	2080	1
DRX 250HP	250A			
DRX 630	400A	0262 40	3130	1
	630A			

Key Locks

Type		Cat.No	MRP	Pack
For DRX 125HP/250HP for Direct Handle	Random	6687 74	3220	1
	A	6687 75	3220	1
	B	6687 76	3220	1

Key Locks

Type		Cat.No	MRP	Pack
For DRX 125HP/250HP for Vary Depth Handle	Random	6687 77	3170	1
	A	6687 78	3170	1
	B	6687 79	3170	1

Key Locks

Type		Cat.No	MRP	Pack
For DRX 630 for Vary Depth Handle	Random	6687 82	3170	1
	A	6687 83	3170	1
	B	6687 84	3170	1

Auxiliary Contact

	Cat.No	MRP	Pack
DRX 125HP DRX 250HP	0271 40	1330	1
DRX 630	4210 11	■	1

Trip Alarm Contact

DRX 125HP DRX 250HP	0271 41	1330	1
DRX 630	4210 11	■	1

Trip Alarm Contact

DRX 125HP DRX 250HP	0271 42	2320	1
------------------------	---------	------	---

* MRP - Maximum Retail Price Inclusive of all taxes including GST.
■ Price available on request.



0270 08



0271 83



0271 40

DRX™ MCCB

Type and frame size	Rated Current (A)	Poles	Cat.Nos	MRP* ₹ / Unit	Pack
---------------------	-------------------	-------	---------	---------------	------

DRX MCCBs

DRX 100 Icu = 10 kA	63 A	3 Pole	0270 39	4450	1/12
	75 A	3 Pole	0270 07	4450	1/12
	100 A	3 Pole	0270 08	4450	1/12
	125 A	3 Pole	0270 09	5840	1/12
	63 A	4 Pole	0270 29	6410	1/12
	75 A	4 Pole	0270 17	6410	1/12
	100 A	4 Pole	0270 18	6410	1/12
	125 A	4 Pole	0270 19	6890	1/12

Description	Cat.Nos	MRP* ₹ / Unit	Pack
-------------	---------	---------------	------

Din Rail Adaptor

DRX 100	0271 87	610	1
---------	---------	-----	---

Rotary Handles - Direct

DRX 100	6687 70	1530	1
---------	---------	------	---

Rotary Handles - Vary-Depth

DRX 100	6687 71	2330	1
---------	---------	------	---

Padlocking Support For Operating Handle

DRX 100	0271 80	2080	1
---------	---------	------	---

Connection Accessories

Set of 2 shields for 3 pole	0271 81	150	1
-----------------------------	---------	-----	---

Sealable Terminal Shields (Moulded Shrouds)

For DRX 100 - 3 pole	0271 83	1990	1
For DRX 100 - 4 pole	0271 84	1860	1

Cage Terminals

For DRX 100 - 3 pole	0271 71	400	1
For DRX 100 - 4 pole	0271 73	380	1

Electrical Accessories

Block with 1 auxiliary (1 AUX)	0271 40	1330	1
Block with 1 alarm (1 AL)	0271 41	1330	1
Block with 1 auxiliary + 1 alarm (1 AUX + 1 AL)	0271 42	2320	1

Current Shunt Coils

200/277 V~ and =	0271 54	2880	1
380/480 V~ and =	0271 55	2880	1

Undervoltage Release Coils

200/240 V~	0271 64	3990	1
380/415 V~	0271 65	3990	1

DRX Spreader Links

3 Links set for TP	6250 10	330	1
4 Links set for FP	6250 11	480	1

Metal One Way Enclosures For MCCB

Cat.Nos	Description	No. of modules	MRP* ₹ / Unit	Pack
5078 05	DRX 100 MCCB enclosure-TP	3	■	1
5078 06	DRX 100 MCCB enclosure-FP	3	3176	1

* MRP - Maximum Retail Price Inclusive of all taxes including GST.
Bold Cat.Nos are products normally available with Legrand (India) Stockists.
Cat.Nos that are not bold - delivery within 4 - 8 weeks from the date of order.
Bold packing quantity is our mandatory packing. Orders to be placed by Legrand (India) Stockist in multiples of the same.



0271 40

CAST RESIN

Transformers

High-Efficiency Power Distribution for Critical Installations



Green T.HE cast resin transformers are designed for efficient and reliable power distribution in indoor environments such as data centres, commercial buildings, and critical infrastructure. Engineered to reduce electrical losses and improve operational performance, they support energy-efficient installations while helping lower CO₂ emissions.

Features

- Power ratings from 100 kVA to 3150 kVA
- 10% reduced No load losses
- Copper or aluminium windings for flexible performance and cost optimisation
- Designed in compliance with IEC 60076-11 & EN 50708
- E2-C2-F1 Certified

Benefits

- High reliability for critical power distribution applications
- Reduced energy losses and operating costs
- Lower maintenance with dry-type transformer construction
- Environmentally responsible solution with reduced lifecycle impact

Scan to know more about the product.



XL³ DO

Smart Switchboard complying IEC61439 1&2



MECHANICAL STRENGTH
• 5-Fold Uprights
• 2mm Load Bearing Member



DMC Busbar Support
to handle 960° C



EXTENDABLE PANEL DESIGN
• Complete Bolted design



Design Ambient
• Designed for 50°C to withstand the harsh Indian conditions



3-WAY CORNER BLOCK
• Zero welding corners
• Higher Life



Special Hinge design
• Spacious compartment
• Easy maintenance



**IP54 /
IP43**



Mechanical Impact
• Tested for 1K10



APPLICATION



Commercial Building



Airports



Data Center



Hospital



Marine & MES



Chemical Industry

LBPLUS DATA

High-Efficiency Lighting and Power Distribution



The LB PLUS range is a modular busbar system engineered for high-performance energy distribution in commercial and industrial ceilings. Designed as a plug-and-play alternative to traditional cable trays, it enables scalable power distribution for standard LED lighting as well as advanced smart lighting management.

Features

- Dual-profile design for standard and long-span installations
- IP55 and IK07 protection for demanding environments
- DATA version supporting DALI and 1–10V lighting control
- Rapid-connect tap-off plugs in 10A, 16A, and 25A options

Benefits

- Enables flexible power distribution with quick addition or relocation of power points
- Reduces installation time with modular plug-and-play assembly
- Supports energy-efficient lighting through intelligent control systems
- Ensures dependable performance with certified safety and compliance standards

Scan to know more about
the product.



RCP IP68

Resin Cast Busbar



Reliable High-Power Energy Distribution

The RCP IP68 Resin Busbar Trunking System is engineered for high-power distribution in demanding industrial environments. Its sealed construction ensures reliable operation in areas exposed to moisture, corrosion, or temporary immersion while complying with IEC 61439-6 Busbar Trunking Systems standards.

Features

- IP68 protection against dust and water immersion
- Current ratings from 630 A to 6300 A for high-power distribution
- Fully encapsulated with Epoxy Resin
- Conductors insulated in polyester film
- Maintenance Free
- Mechanical Impact : IK10

Benefits

- Ensures reliable power distribution in harsh corrosive environments
- Reduced maintenance due to sealed, durable design
- Optimized for continuous high-current power distribution
- Long service life with robust insulation and mechanical strength

Scan to know more about the product.



DSX

Switch Disconnecter & Changeovers

Safety, Strength & Easy DIN-Rail Installation



DSX DIN Frame 2 is a range of switch disconnectors and transfer switches designed for modern power switching applications. With visible contact separation, pop-up ON/OFF indication, and robust AC23A performance, it ensures safe isolation and dependable operation.

Features

- Visible contact separation with pop-up status indication
- Compact DIN-rail or plate mounting design with ratings up to 320 A
- AC23A rated switching performance
- IEC 60947-3 compliant with accessory compatibility

Benefits

- Enhances operator safety with clear switching visibility
- Saves panel space with a compact installation footprint
- Ensures reliable switching for demanding load conditions
- Enables flexible installation with Legrand's MCCB and MCB systems



Range



SD DIN LINE



TSE DIN LINE



SD POWER LINE



TSE POWER LINE

Scan to know more about
the product.



DSX

NEW RANGE FOR POWER SWITCHING NEEDS OF MODERN INSTALLATIONS

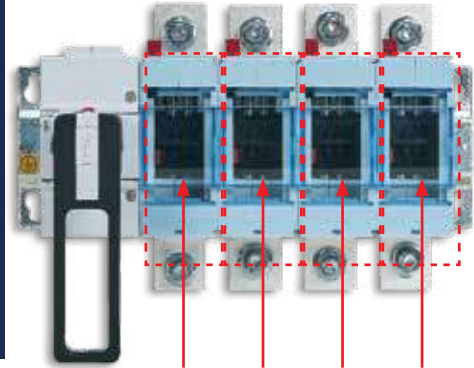

The physical separation of the main contacts is visible through a transparent cover.



Pop up indicators

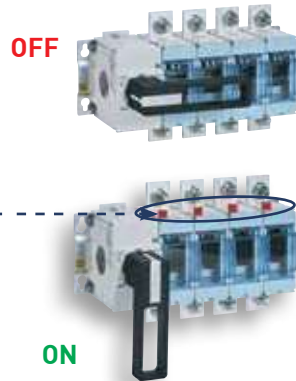

Innovative Design



Safe



Ease of Installation



Robust

DSX SD/TSE

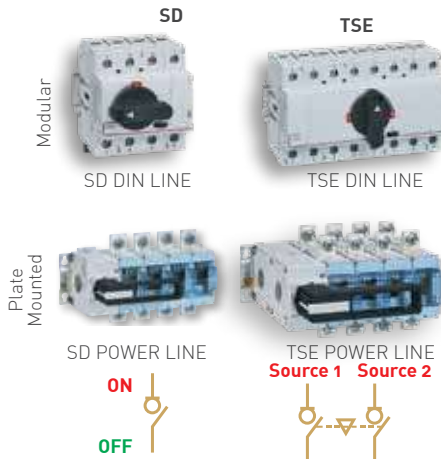

Frame -->	DIN LINE 1	DIN LINE 2	POWER LINE 1	POWER LINE 2
Ratings	32A, 40A, 63A	100A, 125A, 160A	63A, 100A, 125A, 160A	200A, 250A, 320A
Rated Operational Voltage, Ue	690V AC 250V DC	500V AC 250V DC	690V AC 250V DC	690V AC 250V DC
Rated Insulation Voltage, Ui	690V AC	690V AC	1000V AC	
Rated Impulse Voltage, Uimp	8KV	8KV	8KV	12KV
Mechanical Life	10000	7000	10000	10000
Electrical Life	2000	1000	2500	2000
Icw for 1 Sec	1.5KA	2.5KA	8KA	12.5KA

@12000 for DIN LINE 1 SD/ 10000 for DIN LINE 1 TSE

Type	Rated Current (A)	Switch Disconnecter			TSE (Changeover Switch)			TSE (Changeover Switch) with Enclosure		
		Cat.Nos	MRP*/₹/Unit	Pack	Cat.Nos	MRP*/₹/Unit	Pack	Cat.Nos	MRP*/₹/Unit	Pack
DIN Line Frame 1 (3P + N)	32A	4240 06	4040	1	4241 06	7220	1			
	40A	4240 07	4240	1	4241 07	7540	1			
	63A	4240 08	5040	1	4241 08	8800	1			
DIN Line Frame 2 (3P)	100A	4240 03	8260	1	4241 03	■	1			
	125A	4240 04	8500	1	4241 04	■	1			
	160A	4240 05	10620	1	4241 05	■	1			
DIN Line Frame 2 (4P)	100A	4240 09	8730	1	4241 09	17700	1			
	125A	4240 46	9090	1	4241 46	18880	1			
	160A	4240 47	14750	1	4241 47	25960	1			
POWER Line Frame 1 (4P)	63A	4240 82	6020	1	4241 82	10600	1	424192	15790	1
	100A	4240 83	11120	1	4241 83	13310	1	424193	19200	1
	125A	4240 84	13640	1	4241 84	18150	1	424194	22040	1
	160A	4240 85	18410	1	4241 85	20660	1	424195	28400	1
POWER Line Frame 2 (4P)	200A	4240 86	20000	1	4241 86	27620	1	424196	33890	1
	250A	4240 87	23380	1	4241 87	38140	1	424197	45680	1
	320A	4240 88	25820	1	4241 88	39070	1	424198	47870	1

Accessories

	DIN LINE 1		
	Cat.Nos	MRP*/₹/Unit	Pack
Shorting Links for TSE (set of 4)	4242 01	1120	1
Terminal Shield IP20 - 3P#	4242 02	460	1
Terminal Shield IP20 - 1P#	4242 03	370	1
Auxiliary contact (1 NO + 1 NC)	4242 08	590	1
Vary Depth Handle	4242 09	1650	1
	DIN LINE 2		
	Cat.Nos	MRP*/₹/Unit	Pack
DSX Shorting links ECO Frame 2 (160A) 4P - DIN	4242 12	2360	1
DSX DIN Shorting links 160A 3P	4242 11	2120	1

	POWER LINE 1			POWER LINE 2		
	Cat.Nos	MRP*/₹/Unit	Pack	Cat.Nos	MRP*/₹/Unit	Pack
Auxiliary contact 4 NO + 4NC	4242 45	1650	1	4242 45	1650	1
Aux Contact (1NO+1NC) Early Make/Break	4242 44	1950	1	4242 44	1950	1
Spreaders Terminals (One Side i.e. Set of 4)	4242 54	1300	1	4242 38	2580	1
Terminal Shield IP20 - 4P	4242 47	1320	1	4242 36	1520	1
Phase Barriers	4242 51	260	1	4242 43	330	1
Inter Source Barrier	4242 52	330	1	4242 39	530	1
Shorting Links for TSE (Set of 4)	4242 49	3170	1	4242 41	4770	1
Direct Handle	4242 30	1390	1	4242 30	1390	1
Vary Depth Handle	4242 31	1980	1	4242 31	1980	1
Direct Key Lock	4242 34	1390	1	4242 34	1390	1

To be Ordered together as 1 set for 4P SD and 2 sets for 4P TSE.

SD POWER LINE --> Packaging Includes SD, Phase Barriers, Vary Depth Handle.

TSE POWER LINE --> Packaging Includes TSE, Phase Barriers, Inter Source Barrier, Vary Depth Handle, Shorting Links.

■ Price available on request.

EMDX³

Smart Electricity Meters

Sustainable Energy Savings for your Installations



The EMDX³ range of smart multifunction meters enables precise energy monitoring for single-phase and three-phase electrical networks. Designed for commercial and industrial applications, the meters support direct or CT connections and integrate with supervision systems

Features

- Single-phase, three-phase, and CT-based metering options
- MID-certified models with bi-directional energy measurement
- Advanced electrical and power quality monitoring
- Modbus RS-485 and pulse output connectivity

Benefits

- Improves energy efficiency through accurate consumption monitoring
- Supports sustainable energy management and reporting
- Enables reliable sub-metering for billing and cost allocation
- Enhances network reliability with continuous power quality monitoring



A meter should be selected according to the network (single-phase or three-phase) and its maximum current, required displayed values and communication type allowing it to be run by a supervision system.

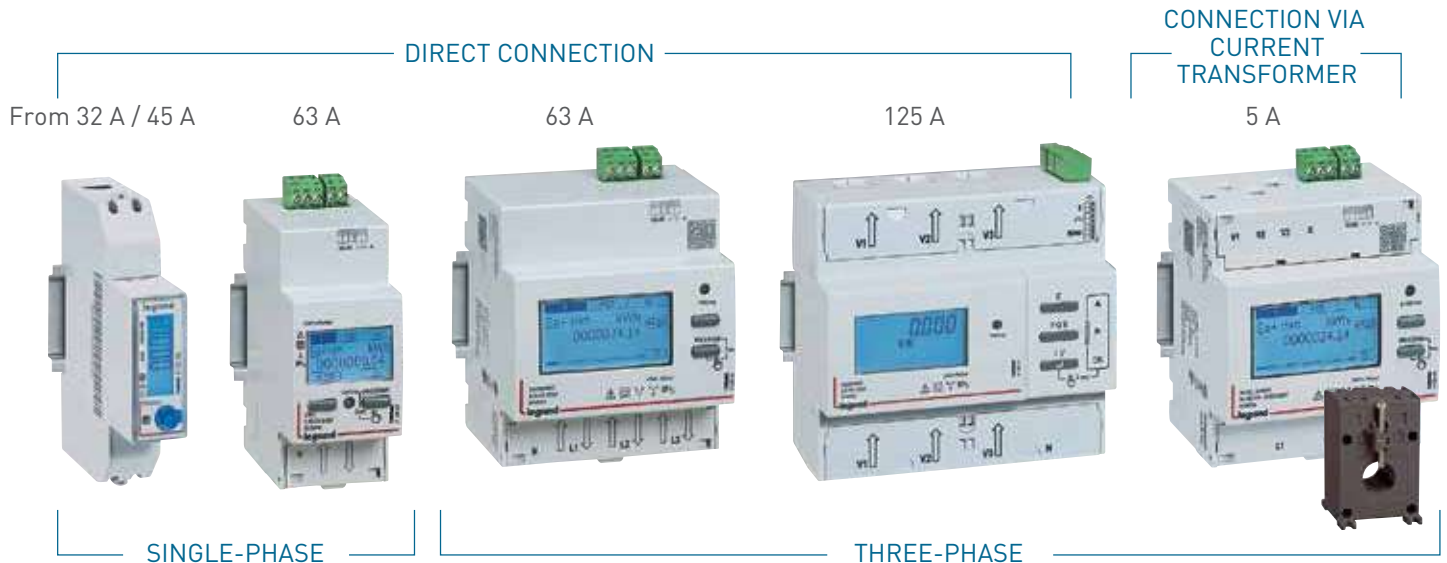

Conforming to standards IEC 61557-12, IEC 62053-21/23, IEC 62052-11, IEC 62052-31, EN 50470-1/3 [for the MID version]

Scan to know more about the product.



EMDX³
Multi-Function Meters for Smart Distribution Board

Din Rail Mounting

Din Rail Meters for Smart Distribution Board. LCD meter with bright graphical back lit display. 1P / 3P Direct connection or connection with CT. Measures kWh as well as other values like current, voltage, active energy, power etc.

Confirms to Standards: IEC 61557-12; IEC 62053-21/23; IEC 62052-11 and IEC 62052-31

MID* compliance ensures accuracy for billing

Dual Tariff meters

WAGES Enabled (1 Pulse input to connect water meter, gas meter etc.)

*MID - Measuring Instruments Directive. The meters comply to MID, ensures the highest levels of reliability and transparency, and in order to provide complete metrological assurance, applications that necessitate the installation of meters dedicated to invoicing purposes.

Direct Connection

Single Phase

Cat. Nos	Current Rating (A)	Description	No. of Modules	MRP* ₹ / Unit	Pack
0046 70	32	32A 1P Energy Meter with Pulse Output	1	■	1
4120 68	45	45A 1P Multi Function Meter with RS-485	1	■	1
4120 69	45	45A 1P Multi Function Meter with Pulse Output - MID	1	■	1
4120 80	63	63A 1P Multi Function Meter with WAGES & Pulse Output	2	■	1
4120 82	63	63A 1P Multi Function Meter with WAGES & Pulse Output - MID	2	■	1
4120 81	63	63A 1P Multi Function Meter with Dual Tariff / WAGES & RS-485	2	■	1
4120 83	63	63A 1P Multi Function Meter with Dual Tariff / WAGES & RS-485 - MID	2	■	1



4120 80

* MRP - Maximum Retail Price Inclusive of all taxes including GST.
 ■ Price available on request.

EMDX³
Multi-Function Meters for Smart Distribution Board

Cat. Nos	Current Rating (A)	Description	No. of Modules	MRP* ₹ / Unit	Pack
----------	--------------------	-------------	----------------	---------------	------

Direct Connection

Three Phase

4120 90	63	63A 3P Multi Function Meter with WAGES & Pulse Output	4	■	1
4120 92	63	63A 3P Multi Function Meter with WAGES & Pulse Output - MID	4	■	1
4120 91	63	63A 3P Multi Function Meter with Dual Tariff / WAGES & RS-485	4	■	1
4120 93	63	63A 3P Multi Function Meter with Dual Tariff / WAGES & RS-485 - MID	4	■	1
4120 74	125	125A 3P Multi Function Meter with Dual Tariff / WAGES, RS-485 & Pulse Output	6	■	1
4120 75	125	125A 3P Multi Function Meter with Dual Tariff / WAGES, RS-485 & Pulse Output - MID	6	■	1



4120 91

Connection with CT

4120 40	5	3P with CT Multi Function Meter with WAGES & Pulse Output	4	■	1
4120 42	5	3P with CT Multi Function Meter with WAGES & Pulse Output - MID	4	■	1
4120 41	5	3P with CT Multi Function Meter with Dual Tariff / WAGES & RS-485	4	■	1
4120 43	5	3P with CT Multi Function Meter with Dual Tariff / WAGES & RS-485 - MID	4	■	1

Bold Cat.Nos are products normally available with Legrand (India) Stockists. Cat.Nos that are not bold - delivery within 4 - 8 weeks from the date of order. Bold packing quantity is our mandatory packing. Orders to be placed by Legrand (India) Stockist in multiples of the same.

EMDX³ Digital Panel Meter

Cat. Nos	Description	MRP* ₹ / Unit	Pack
----------	-------------	------------------	------

Modular Multi Function Meter

LCD meter with bright graphical back lit display.
 4 Dedicated Keys (V / I / P Q S / E P F F)
 Precision class 1 / 0.5
 Connection with current transformers (CT)
 Measurement of currents, voltages, frequency, active, reactive and apparent power, power factor, active and reactive energy
 4 tariff metering
 THD voltages, currents and harmonic analysis up to order 25th (available on Modbus COM port)
 Programmable alarms on all functions
 RS 485 and pulse output
 Phase sequence correction diagnostic
 Customized display page

Cat. Nos	Current Rating (A)	Description	No. of Modules	MRP* ₹ / Unit	Pack
4120 45	5	Modular Multi Function Meter with THD - RS-485 & Pulse Output CI 1	4	■	1
4120 51	5	4 Tariff Modular Multi Function Meter with Individual THD, Programmable alarms - RS-485 & Pulse Output CI 0.5	4	■	1



4120 51

Pulse Concentrator

For collecting and transmitting measurements taken by 12 universal pulse electricity meters.
 Collects pulses from other meters (gas meters, water meters, etc.) RS-485 output

Cat. Nos	Description	No. of Modules	MRP* ₹ / Unit	Pack
4120 65	Pulse Concentrator	4	■	1



4120 65

* MRP - Maximum Retail Price Inclusive of all taxes including GST.
 ■ Price available on request.

EMDX³ Digital Panel Meter

Cat. Nos	Description	MRP* ₹ / Unit	Pack
----------	-------------	------------------	------

Communication Interface

For mounting on door or solid faceplate
 Dimensions: 96 x 96 x 62 mm
 LCD meter with bright graphical back lit display.
 4 Dedicated Keys (V / I / P Q S / E P F F)
 Measurement of currents, voltages, active, reactive and apparent power and power factor

Metering:

- Active energy consumed or produced
- Reactive energy consumed or produced
- Operating time
- Pulses
- THD voltages, currents, and individual harmonic up to order 25(1)
- RS 485 communication and Pulse output
- Phase sequence correction diagnostic
- Optorelays with potential-free SPST-NO contact
- Customized display page

Cat. Nos	Description	MRP* ₹ / Unit	Pack
4120 47	Multi Function Meter with THD - RS-485 & Pulse Output CI 1	■	1
4120 52	Advance Multi Function Meter with Individual THD - RS-485 & Pulse Output CI 0.5	■	1



4120 52

Power Quality & Network Analyzer with Data Logger

Dimensions: 96 x 96 x 62 mm
 LCD meter with bright graphical back lit display.
 Customized display page
 4 Dedicated Keys (V / I / P Q S / E P F F)
 Precision class: 0.5
 Measurement of currents, voltages, active, reactive

Bold Cat.Nos are products normally available with Legrand (India) Stockists. Cat.Nos that are not bold - delivery within 4 - 8 weeks from the date of order. Bold packing quantity is our mandatory packing. Orders to be placed by Legrand (India) Stockist in multiples of the same.

EMDX³
Power Quality & Network Analyzer with Data Logger

Cat. Nos	Description	MRP* ₹ / Unit	Pack
----------	-------------	------------------	------

and apparent power, internal temperature and power factor

Metering:

- active energy consumed or produced
- Reactive energy consumed or produced
- Operating time
- THD
- Programmable alarms on all functions
- Power quality functions: harmonics (U & I) to 50th, dips, swells, interruption, rapid voltage change and flickers
- Memory embedded (8 Mb)
- RTC (real time clock)
- Can take 4 EMDX3 optional modules

Cat. Nos	Description	MRP* ₹ / Unit	Pack
----------	-------------	------------------	------

4120 53	Power Quality & Network Analyzer with Data Logger	■	1
4120 55	R485 communication module with Modbus link	■	1
4120 59	2 Pulse output module for energy count	■	1
4120 57	2 inputs / 2 outputs module	■	1
4120 60	2 analog outputs module	■	1
4120 58	Temperature module	■	1

* MRP - Maximum Retail Price Inclusive of all taxes including GST.
 ■ Price available on request.



0046 89

EMDX³
Energy Management Multi-Support Web Servers

Cat. Nos	Description	MRP* ₹ / Unit	Pack
----------	-------------	------------------	------

RS485 / Ethernet

0046 89	IP converter For RS 485/Ethernet conversion for connecting electricity meters and measurement control units to an IP network	■	1
---------	---	---	---

Energy Management Multi-Support Web Servers

Allow remote configuration, test, control and visualization, via a web browser on PCs, smartphones, web viewers, tablet computers, of data

Features

- In-built IP converter
- Power supply: 9 to 28 V= with the help of a single-phase switching mode power supply Cat.No 1 467 21 to be ordered separately
- With the Legrand Power supervision system, circuit breakers are integrated in a supervision system
- You can therefore check the status of the circuit breakers, measure the electrical values and control the circuit breakers remotely
- MODBUS protocol

Cat. Nos	Description	MRP* ₹ / Unit	Pack
----------	-------------	------------------	------

4149 47	For 10 Modbus addresses or 10 pulse modules	■	1
4149 48	For 32 Modbus addresses or 32 pulse modules	■	1
4149 49	For 255 Modbus addresses or 255 pulse modules Supplied with external power supply and fixing" brackets	■	1



4149 48

Bold Cat.Nos are products normally available with Legrand (India) Stockists. Cat.Nos that are not bold - delivery within 4 - 8 weeks from the date of order. Bold packing quantity is our mandatory packing. Orders to be placed by Legrand (India) Stockist in multiples of the same.

PMX

DIGITAL PANEL METERS

Precise Monitoring for Smarter Energy Management



The PMX series of digital panel meters provides a comprehensive metering solution for low-voltage installations, ranging from basic volt and amp meters to advanced multifunction meters and power quality analyzers. These meters help monitor, analyse, and optimise electrical loads across panels, generators, and industrial equipment.

Features

- Wide range from basic meters to advanced multifunction models
- True RMS measurements with high accuracy
- Universal power supply with flexible CT/PT configurations
- Communication-ready with Modbus and pulse outputs

Benefits

- Improves visibility of electrical parameters for better load management
- Enables accurate energy monitoring and cost allocation
- Enhances reliability through power quality and demand tracking
- Simplifies panel design by replacing multiple analog meters with a compact digital solution



Scan to know more about the product.



PMX Digital Panel Meters

Cat.Nos	Model Series	Description	MRP* ₹ / Unit	Pack
---------	--------------	-------------	------------------	------

PMX 1000 Precise Single Function Meters

Features

- **RoHS Compliance**
- True RMS measurement
- High accuracy with class 1 as per IEC 62053-21
- Volts & Amps: $\pm 1.0\%$ of Rated Current.
- **Bright 7 Segment LED display with four digit resolution and 14mm Height**
- Auto and Manual scrolling
- **Site selectable CT/PT ratios**
- Site selectable CT Secondary 1 A/5 A
- **Site selectable 3Phase 4Wire, 3Phase 3Wire & 1Ph configuration**
- Suitable for 50/60 Hz
- Wide range of control power supply 80 - 300 V AC, 40-70 Hz
- Low burden < 0.2 VA per phase Volts & Amps
- Average & Phase wise measurements
- Password protection



4149 77



4149 78

4149 75	PMX 1100	1Ph Ammeter CI 1	1652	1
4149 76	PMX 1200	1Ph Voltmeter CI 1	1652	1
4149 77	PMX 1103	3 Ph Ammeter CI 1	2392	1
4149 78	PMX 1203	3Ph Voltmeter CI 1 + Hz	2392	1

PMX 4000 True VAF + PF Meter

Features

- **RoHS Compliance**
- **Displays Current, line to neutral & line to line Voltages, frequency & Power Factor. (VA & PF - Phase Wise & Average)**
- **Display on Hours**
- True RMS measurement with simulations sampling of Current & Voltage
- High accuracy with class 1 as per IEC 62053-21 Volts & Amps: $\pm 1.0\%$ of Rated Current.
- **3 Row Display with LED status for different parameter selection.**
- Auto and Manual scrolling
- Site selectable CT/PT ratios
- Site selectable CT Secondary 1 A/5 A
- Site selectable 3Phase 4Wire, 3Phase 3Wire & 1Ph configuration
- Suitable for 50/60 Hz
- Universal control power supply 80 - 300 V AC/DC, 40-70 Hz
- Low burden < 0.2 VA per phase Volts & Amps
- Average & Phase wise measurements
- **Password protection**
- **Seamless integration with EMS/SCADA system with RS485 serial channel communication,**



4149 82

PMX Digital Panel Meters

Cat.Nos	Model Series	Description	MRP* ₹ / Unit	Pack
---------	--------------	-------------	------------------	------

Industry standard Modbus RTU protocol.

4149 79	PMX 4000	3 Ph VAF + PF meter CI 1	4050	1
4149 80	PMX 4000	3 Ph VAF + PF meter CI 1 with RS485	4830	1



4149 80

PMX 5000 Smart Energy Meters For Smart Energy Billing

Features

- **RoHS Compliance**
- kWh/kVA
- **Old Energy register for back up of last cleared energy values**
- Bright LED with parameter name and value
- Auto scaling capability in adjustment of Kilo, Mega, Giga.
- kWh / kVA / PF / W - any one programmable
- **Positive energy accumulation even with CT polarity reversal with reverse lock program**
- High Accuracy with class 1 as per IEC 62053-21
- Site selectable CT/PT ratios
- Site selectable CT Secondary 1 A/5 A
- Universal control power supply 80 - 300 V AC/DC, 40-70 Hz
- Password protection for tamper proofing
- **Seamless integration with EMS/SCADA system with RS485 serial channel communication, Industry standard Modbus RTU protocol.**
- **Pulse output for integration into a process through PLC/DCS for online energy management**
- Provision for Tamper proofing with meter casing* *optional strip for tamper proofing.

4149 81	PMX 5000	kWh LED meter CI 1	4642	1
4149 82	PMX 5000	kWh LED meter CI 1 with RS485	5332	1
4149 83	PMX 5000	kWh LED meter CI 1 with Pulse Output	6480	1

PMX 6000 Multi Dual Source Meter

Features

- **RoHS Compliance**
- **Bright LED display for showing parameters for both EB & DG**
- **Displays full range of parameters**
Basic : VLL, VLN, A (Avg. & Phase wise), F
Power: W, PF (Avg. & Phase wise)
Energy: Wh
- **Load Hours, Run Hours, Old Wh, Old Load Hours for both EB & DG.**
- **DG Sensing input - 230 VAC**
- Auto scaling capability in adjustment of Kilo, Mega, Giga.
- Positive energy accumulation even with CT polarity reversal with reverse lock program.
- High Accuracy with class 1 as per IEC 62053-21 & class 0.5 as per IEC 62053-22

Bold Cat.Nos are products normally available with Legrand (India) Stockists. Cat.Nos that are not bold - delivery within 4 - 8 weeks from the date of order. Bold packing quantity is our mandatory packing. Orders to be placed by Legrand (India) Stockist in multiples of the same.

* MRP - Maximum Retail Price Inclusive of all taxes including GST.

PMX Digital Panel Meters

Cat.Nos	Model Series	Description	MRP* ₹ / Unit	Pack
---------	--------------	-------------	------------------	------

- Site selectable CT/PT ratios
- Site selectable CT Secondary 1 A/5 A
- Universal control power supply 80 – 300 V AC/DC, 40-70 Hz
- Password protection for tamper proofing
- **Seamless integration with EMS/SCADA system with RS485 serial channel communication, Industry standard Modbus RTU protocol.**
- Provision for Tamper proofing with meter casing*
*optional strip for tamper proofing



4149 85

4149 84	PMX 6000	Dual Source LED meter CI 1 with RS485	8280	1
4149 85	PMX 6000	Dual Source LED meter CI 0.5 with RS485	9860	1

PMX 7000 Multifunction Meter

Features

- **RoHS Compliance**
- **Bright LED display to view more than 25 parameters.**
- Displays full range of parameters
Basic : VLL, VLN, A (Avg. & Phase Wise), F
Power: W, PF, VA (Avg. & Phase Wise)
Energy: Wh,
- **Load Hours, Run Hours, Old Wh, Old Load Hours**
- Auto scaling capability in adjustment of Kilo, Mega, Giga.
- **Positive energy accumulation even with CT polarity reversal with reverse lock programmable**
- High Accuracy with class 1 as per IEC 62053-21
- Site selectable CT/PT ratios
- Site selectable CT Secondary 1 A/5 A
- Universal control power supply 80 – 300 V AC/DC, 40-70 Hz
- Password protection for tamper proofing
- **Seamless integration with EMS/SCADA system with RS485 serial channel communication, Industry standard Modbus RTU protocol**
- Provision for Tamper proofing with meter casing*
*optional strip for tamper proofing



4149 90



4149 91

4149 90	PMX 7000	MFM (VAF + W/VA/PF/Wh) LED meter CI 1 with RS485 [^]	8230	1
4149 91	PMX 7300	MFM LED meter CI 1	9950	1
4149 92	PMX 7300	MFM LED meter CI 1 with RS485	11880	1

* MRP - Maximum Retail Price Inclusive of all taxes including GST.

PMX Digital Panel Meters

Cat.Nos	Model Series	Description	MRP* ₹ / Unit	Pack
---------	--------------	-------------	------------------	------

PMX 7400

Advance Multifunction Meter / Load Manager / Demand Monitor

Features

- **RoHS Compliance**
- **Advance multifunction meter with High/Low recording of VLL, VLN, A, Hz, PF, Var with time stamp.**
- **Voltage & Current THD (Total Harmonics Distortion) with Individual harmonics up to 31st order.**
- **K-factor V & A to keep check on the losses due to harmonic load currents & their effects on transformer heating.**
- Load manager with demand monitoring
- **RTC based Demand management**
- **Import/Export/Net monitoring of Wh, VAh, VARh Inductive/Capacitive, Load hours**
- Auto scaling capability in adjustment of Kilo, Mega, Giga.
- **Positive energy accumulation even with CT polarity reversal with reverse lock programmable**
- High Accuracy with class 1 as per IEC 62053-21 & class 0.5s as per IEC 62053-22
- Site selectable CT/PT ratios
- Site selectable CT Secondary 1 A/5 A
- Universal control power supply 80-300 V AC/DC, 40-70 Hz
- Password protection for tamper proofing
- **Seamless integration with EMS/SCADA system with RS485 serial channel communication, Industry standard Modbus RTU protocol.**
- Byte order option – Field Programmable Float/ Little Endian/ Big Endian data formats



4149 96

4149 93	PMX 7400	MFM + THD LED meter CI 1 with RS485	15900	1
4149 94	PMX 7400	MFM + THD LED meter CI 0.5 with RS485	19500	1
4149 95	PMX 7410	MFM + THD + Demand monitoring LED meter CI 1 with RS485	23090	1
4149 96	PMX 7420	MFM + THD with Individual + Harmonics + Demand + Import/Export LED meter CI 1 with RS485	23930	1

Bold Cat.Nos are products normally available with Legrand (India) Stockists. Cat.Nos that are not bold - delivery within 4 - 8 weeks from the date of order. Bold packing quantity is our mandatory packing. Orders to be placed by Legrand (India) Stockist in multiples of the same.

PMX Digital Panel Meters

Cat.Nos	Model Series	Description	MRP* ₹ / Unit	Pack
4149 97	PMX 7420	MFM + THD with Individual + Harmonics + Demand + Import/Export LED meter CI 0.5s with RS485	27680	1

PMX 8000 Advance Demand Controller

Features

- RoHS Compliance
- Demand controller with 4 relay output
- High memory Data Logger (8MB) for storing multiple parameters.
- Predictive demand with date & time stamping
- Voltage & Current THD (Total Harmonics Distortion) with Individual harmonics up to 31st order.
- K-factor V & A to keep check on the losses due to harmonic load currents & their effects on transformer heating.
- Advance multifunction meter with High/Low recording of VLL, VLN, A, Hz, PF, Var with time stamp.
- RTC based Demand management
- Import/Export/Net monitoring of Wh, VAH, VARh Inductive/Capacitive, Load hours
- Auto scaling capability in adjustment of Kilo, Mega, Giga.
- Positive energy accumulation even with CT polarity reversal with reverse lock programmable
- High Accuracy with class 1 as per IEC 62053-21
- Site selectable CT/PT ratios
- Site selectable CT Secondary 1 A/5 A
- Universal control power supply 80 - 300 V AC/DC, 40-70 Hz
- Password protection for tamper proofing
- Seamless integration with EMS/SCADA system with RS485 serial channel communication, Industry standard Modbus RTU protocol.
- Byte order option - Field Programmable Float/ Little Endian/ Big Endian data formats



4149 98

4149 98	PMX 8000	Demand Controller CI 1 with data logger + Bi directional + THD with Individual Harmonics	53650	1
---------	-------------	--	-------	---

* MRP - Maximum Retail Price Inclusive of all taxes including GST.

CTX³ MINI Contactors

Ultra-Compact Contactor for Motor, Lighting & Heating Control (Up to 16 A)



CTX³ MINI contactors are compact switching devices designed for reliable control of motors, lighting, and heating circuits up to 16 A. With a space-saving design, flexible mounting options, and integrated auxiliary contacts, they provide an efficient solution for modern distribution boards and control panels where space and reliability are essential.

Features

- Ultra-compact 3-pole design up to 16 A
- DIN-rail or plate mounting options
- IP2X protected screw terminals
- Integrated auxiliary contact for control signalling

Benefits

- Enables space-efficient installation in electrical panels
- Simplifies and speeds up installation and retrofits
- Enhances safety with touch-proof terminal protection
- Ensures reliable switching for motor, lighting, and heating applications



Scan to know more about the product.

CTX³ RTX³ MPX³

Motor Control Range

Uncompromising Performance for Motor Protection and Control



The CTX³ contactors, RTX³ thermal relays and MPX³ motor protection circuit breakers form a complete and coordinated range for reliable motor protection and control. Designed for commercial and industrial applications, the range combines compact dimensions with robust performance.

Features

- CTX³ contactors and RTX³ thermal relays up to 800 A
- MPX³ motor protection circuit breakers up to 100 A
- High endurance with reliable overload and short-circuit protection
- Compact design with flexible mounting and accessories

Benefits

- Enables simpler motor control architecture with an integrated solution
- Optimises panel layout with reduced wiring complexity
- Enhances system reliability with robust motor protection
- Supports flexible installations across diverse motor applications



Scan to know more about the product.



Mini Contactors CTX³ 6 to 16 A Industrial Contactors

Cat.Nos	Max. opt. current AC 3	Max. opt. current AC 1	Control voltage	MRP* ₹ / Unit	Pack
---------	------------------------	------------------------	-----------------	---------------	------

An Ultra Compact Solution Upto 16A (AC3) 3P & 4P

For Switching Motors, Lighting and Heating Circuits
Ultra High Reliability
Ultra High Endurance
Ultra Low Wattloss

Features

Conforms to IEC/EN 60947-4-1
CE & UL Certified
Range From 6A to 16A AC3
Available in 3P & 4P
Click fit accessories
Ultra Compact design
Front and side add on auxiliary contact
Mechanical Interlock unit
mini Thermal Overload Relay

Spare Coils available

RoHS Compliant

3 Pole Mini Contactors

With integrated auxiliary contact
Power terminals: screw terminals



4170 00



4170 01

6 A - Integrated auxiliary contact 1 NO

4170 00	6 A	20 A	24 V~	1810	1
4170 01	6 A	20 A	24 V=	2470	1
4170 04	6 A	20 A	110 V~	1810	1
4170 06	6 A	20 A	230 V~	1810	1
4170 09	6 A	20 A	415 V~	1810	1

6 A - Integrated auxiliary contact 1 NC

4170 10	6 A	20 A	24 V~	1810	1
4170 11	6 A	20 A	24 V=	2470	1
4170 14	6 A	20 A	110 V~	1810	1
4170 16	6 A	20 A	230 V~	1810	1
4170 19	6 A	20 A	415 V~	1810	1

9 A - Integrated auxiliary contact 1 NO

4170 20	9 A	20 A	24 V~	1980	1
4170 21	9 A	20 A	24 V=	2630	1
4170 24	9 A	20 A	110 V~	1980	1
4170 26	9 A	20 A	230 V~	1980	1
4170 29	9 A	20 A	415 V~	1980	1

9 A - Integrated auxiliary contact 1 NC

4170 30	9 A	20 A	24 V~	1980	1
4170 31	9 A	20 A	24 V=	2630	1
4170 34	9 A	20 A	110 V~	1980	1
4170 36	9 A	20 A	230 V~	1980	1
4170 39	9 A	20 A	415 V~	1980	1

12 A - Integrated auxiliary contact 1 NO

4170 40	12 A	20 A	24 V~	2150	1
4170 41	12 A	20 A	24 V=	3210	1
4170 44	12 A	20 A	110 V~	2150	1
4170 46	12 A	20 A	230 V~	2150	1
4170 49	12 A	20 A	415 V~	2150	1

12 A - Integrated auxiliary contact 1 NC

4170 50	12 A	20 A	24 V~	2150	1
4170 51	12 A	20 A	24 V=	3210	1
4170 54	12 A	20 A	110 V~	2150	1
4170 56	12 A	20 A	230 V~	2150	1
4170 59	12 A	20 A	415 V~	2150	1

* MRP - Maximum Retail Price Inclusive of all taxes including GST.
■ Price available on request.

Mini Contactors CTX³ 6 to 16 A Industrial Contactors

Cat.Nos	Max. opt. current AC 3	Max. opt. current AC 1	Control voltage	MRP* ₹ / Unit	Pack
---------	------------------------	------------------------	-----------------	---------------	------

16 A - Integrated auxiliary contact 1 NO

4170 60	16 A	20 A	24 V~	2580	1
4170 61	16 A	20 A	24 V=	3720	1
4170 64	16 A	20 A	110 V~	2580	1
4170 66	16 A	20 A	230 V~	2580	1
4170 69	16 A	20 A	415 V~	2580	1

16 A - Integrated auxiliary contact 1 NC

4170 70	16 A	20 A	24 V~	2580	1
4170 71	16 A	20 A	24 V=	3720	1
4170 74	16 A	20 A	110 V~	2580	1
4170 76	16 A	20 A	230 V~	2580	1
4170 79	16 A	20 A	415 V~	2580	1

4-Pole Mini Contactors

Without integrated auxiliary contact
Power terminals: screw terminals

Cat.Nos	Max. opt. current AC 1	Max. opt. current AC 3	Control voltage	MRP* ₹ / Unit	Pack
---------	------------------------	------------------------	-----------------	---------------	------

20 A

4171 40	20 A	16 A	24 V~	2340	1
4171 41	20 A	16 A	24 V=	2960	1
4171 44	20 A	16 A	110 V~	2340	1
4171 46	20 A	16 A	230 V~	2340	1
4171 49	20 A	16 A	415 V~	2340	1

Mini Thermal Overload Relays RTX³ mini

For Mini Contactors

Cat.Nos	Setting Range	MRP* ₹ / Unit	Pack
---------	---------------	---------------	------

Features

Conforms to IEC/EN 60947-4-1
CE & UL Certified
Thermal protection of circuits against overload, long starting times, and phase failure
Trip Class 10A
Trip Indication
Manual/Automatic Reset
Integrated auxiliary contacts 1 NO & 1 NC

Thermal Overload Relays For 3 Pole Mini Contactors

Class 10 A - Integrated auxiliary contacts 1 NO + 1 NC

4170 80	0.1~0.16 A	2090	1
4170 81	0.16~0.25 A	2090	1
4170 82	0.25~0.4 A	2090	1
4170 83	0.4~0.63 A	2090	1
4170 84	0.63~1 A	2090	1
4170 85	1~1.6 A	2090	1
4170 86	1.6~2.5 A	2090	1
4170 87	2.5~4 A	2090	1
4170 88	4~6 A	2090	1
4170 89	5~8 A	2090	1
4170 90	6~9 A	2090	1
4170 91	7~10 A	2090	1
4170 92	9~13 A	2090	1
4170 93	12~16 A	2090	1



4170 88

Bold Cat.Nos are products normally available with Legrand (India) Stockists.
Cat.Nos that are not bold - delivery within 4 - 8 weeks from the date of order.
Bold packing quantity is our mandatory packing. Orders to be placed by Legrand (India) Stockist in multiples of the same.

Mini Thermal Overload Relays

RTX³ mini

Accessories for Mini Contactors CTX³

Cat.Nos	Setting Range	MRP* ₹ / Unit	Pack
---------	---------------	------------------	------

Add on Auxiliary Blocks for Mini Contactors

High Thermal current - 10 A
Ith: 10 A

Front Mounting

4171 50	1 NO + 1 NC	610	10
4171 51	2 NO	610	10
4171 52	2 NC	610	10
4171 53	4 NO	940	10
4171 54	3 NO + 1 NC	940	10
4171 55	2 NO + 2 NC	940	10
4171 56	1 NO + 3 NC	940	10
4171 57	4 NC	940	10

Side Mounting

4171 58	1 NO	610	10
4171 59	1 NC	610	10

Interlock Unit

4171 60	Mechanical interlock for mini contactors	980	5
---------	--	-----	---

Spare Coils

4171 70	24 V~	1090	5
4171 71	24 V=	1480	5
4171 74	110 V~	1090	5
4171 76	230 V~	1090	5
4171 79	415 V~	1090	5

Power Contactors CTX³

Uncompromising Performance For Motor

Protection & Control

Range from 9A to 800A (AC3) Contactors

Features

Conforms to IEC/EN 60947-4-1

CE & UL Certified

Extra Mechanical life upto 15 Million

Extra Electrical life upto 2.5 Million

Extra Low Consumption

Compact size

integrated auxiliary contacts

Front safety Cover to prevent dust entry

Direct Clipping on Din Rail

Both Sides Terminal connection

Click fit accessories

Interlocking kits

Spare Coils

RoHS Complaint

3 Pole Contactors CTX³

9 A To 100 A Industrial Contactors

Cat.Nos	Max. opt. current AC 3	Max. opt. current AC 1	Control voltage	MRP* ₹ / Unit	Pack
---------	------------------------	------------------------	-----------------	------------------	------

CTX³ 22

With integrated auxiliary contacts

Power terminals: screw terminals

9 A - Integrated auxiliary contacts 1 NO + 1 NC

4160 80	9 A	25 A	24 V~	1940	1
4160 81	9 A	25 A	24 V=	3190	1
4160 82	9 A	25 A	48 V~	1940	1
4160 83	9 A	25 A	48 V=	3190	1
4160 84	9 A	25 A	110 V~	1940	1
4160 86	9 A	25 A	230 V~	1940	1
4160 88	9 A	25 A	380 V~	1940	1
4160 89	9 A	25 A	415 V~	1940	1

* MRP - Maximum Retail Price Inclusive of all taxes including GST.

3 Pole Contactors CTX³

9 A to 100 A Industrial Contactors

Cat.Nos	Max. opt. current AC 3	Max. opt. current AC 1	Control voltage	MRP* ₹ / Unit	Pack
---------	------------------------	------------------------	-----------------	------------------	------

12 A - Integrated auxiliary contacts 1 NO + 1 NC

4160 90	12 A	25 A	24 V~	2190	1
4160 91	12 A	25 A	24 V=	3450	1
4160 92	12 A	25 A	48 V~	2190	1
4160 93	12 A	25 A	48 V=	3450	1
4160 94	12 A	25 A	110 V~	2190	1
4160 96	12 A	25 A	230 V~	2190	1
4160 98	12 A	25 A	380 V~	2190	1
4160 99	12 A	25 A	415 V~	2190	1

18 A - Integrated auxiliary contacts 1 NO + 1 NC

4161 00	18 A	40 A	24 V~	2580	1
4161 01	18 A	40 A	24 V=	4200	1
4161 02	18 A	40 A	48 V~	2580	1
4161 03	18 A	40 A	48 V=	4200	1
4161 04	18 A	40 A	110 V~	2580	1
4161 06	18 A	40 A	230 V~	2580	1
4161 08	18 A	40 A	380 V~	2580	1
4161 09	18 A	40 A	415 V~	2580	1

22 A - Integrated auxiliary contacts 1 NO + 1 NC

4161 10	22 A	40 A	24 V~	3190	1
4161 11	22 A	40 A	24 V=	5400	1
4161 12	22 A	40 A	48 V~	3190	1
4161 13	22 A	40 A	48 V=	5400	1
4161 14	22 A	40 A	110 V~	3190	1
4161 16	22 A	40 A	230 V~	3190	1
4161 18	22 A	40 A	380 V~	3190	1
4161 19	22 A	40 A	415 V~	3190	1

CTX³ 40

With integrated auxiliary contacts

Power terminals: screw terminals

32 A - Integrated auxiliary contacts 2 NO + 2 NC

4161 20	32 A	50 A	24 V~	6670	1
4161 21	32 A	50 A	24 V=	11540	1
4161 22	32 A	50 A	48 V~	6670	1
4161 23	32 A	50 A	48 V=	11540	1
4161 24	32 A	50 A	110 V~	6670	1
4161 26	32 A	50 A	230 V~	6670	1
4161 28	32 A	50 A	380 V~	6670	1
4161 29	32 A	50 A	415 V~	6670	1

40 A - Integrated auxiliary contacts 2 NO + 2 NC

4161 30	40 A	60 A	24 V~	9880	1
4161 31	40 A	60 A	24 V=	14460	1
4161 32	40 A	60 A	48 V~	9880	1
4161 33	40 A	60 A	48 V=	14460	1
4161 34	40 A	60 A	110 V~	9880	1
4161 36	40 A	60 A	230 V~	9880	1
4161 38	40 A	60 A	380 V~	9880	1
4161 39	40 A	60 A	415 V~	9880	1

CTX³ 65

With integrated auxiliary contacts

50 A - Integrated auxiliary contacts 2 NO + 2 NC

Screw terminals

4161 40	50 A	70 A	24 V~	12080	1
4161 41	50 A	70 A	24 V=	16640	1
4161 42	50 A	70 A	48 V~	12080	1
4161 43	50 A	70 A	48 V=	16640	1
4161 44	50 A	70 A	110 V~	12080	1
4161 46	50 A	70 A	230 V~	12080	1
4161 48	50 A	70 A	380 V~	12080	1
4161 49	50 A	70 A	415 V~	12080	1

Bold Cat.Nos are products normally available with Legrand (India) Stockists.

Cat.Nos that are not bold - delivery within 4 - 8 weeks from the date of order.

Bold packing quantity is our mandatory packing. Orders to be placed by Legrand (India) Stockist in multiples of the same.



4171 55



4160 96



4161 26



4161 46

3 pole contactors CTX³ 9 A To 100 A Industrial Contactors

Cat.Nos	Max. opt. current AC 3	Max. opt. current AC 1	Control voltage	MRP* ₹ / Unit	Pack
---------	------------------------	------------------------	-----------------	---------------	------

65 A - Integrated auxiliary contacts 2 NO + 2 NC
Screw terminals

4161 60	65 A	100 A	24 V~	16060	1
4161 61	65 A	100 A	24 V=	18700	1
4161 62	65 A	100 A	48 V~	16060	1
4161 63	65 A	100 A	48 V=	18700	1
4161 64	65 A	100 A	110 V~	16060	1
4161 66	65 A	100 A	230 V~	16060	1
4161 68	65 A	100 A	380 V~	16060	1
4161 69	65 A	100 A	415 V~	16060	1

CTX³ 100

With integrated auxiliary contacts

75 A - Integrated auxiliary contacts 2 NO + 2 NC
Screw terminals

4161 80	75 A	110 A	24 V~	19940	1
4161 81	75 A	110 A	24 V=	22370	1
4161 82	75 A	110 A	48 V~	19940	1
4161 83	75 A	110 A	48 V=	22370	1
4161 84	75 A	110 A	110 V~	19940	1
4161 86	75 A	110 A	230 V~	19940	1
4161 88	75 A	110 A	380 V~	19940	1
4161 89	75 A	110 A	415 V~	19940	1

85 A - Integrated auxiliary contacts 2 NO + 2 NC
Screw terminals

4162 00	85 A	135 A	24 V~	20640	1
4162 01	85 A	135 A	24 V=	23660	1
4162 02	85 A	135 A	48 V~	20640	1
4162 03	85 A	135 A	48 V=	23660	1
4162 04	85 A	135 A	110 V~	20640	1
4162 06	85 A	135 A	230 V~	20640	1
4162 08	85 A	135 A	380 V~	20640	1
4162 09	85 A	135 A	415 V~	20640	1

100 A - Integrated auxiliary contacts 2 NO + 2 NC
Screw terminals

4162 20	100 A	160 A	24 V~	25720	1
4162 21	100 A	160 A	24 V=	28920	1
4162 22	100 A	160 A	48 V~	25720	1
4162 23	100 A	160 A	48 V=	28920	1
4162 24	100 A	160 A	110 V~	25720	1
4162 26	100 A	160 A	230 V~	25720	1
4162 28	100 A	160 A	380 V~	25720	1
4162 29	100 A	160 A	415 V~	25720	1

3 Pole Contactors CTX³ 130 A To 800 A Industrial Contactors

CTX 150

With integrated auxiliary contacts

130 A - Integrated auxiliary contacts 2 NO + 2 NC
Screw terminals

4162 40	130 A	160 A	24 V~	38240	1
4162 41	130 A	160 A	24 V=	42020	1
4162 42	130 A	160 A	48 V~	38240	1
4162 43	130 A	160 A	48 V=	42020	1
4162 46	130 A	160 A	100-240 V~/=	38240	1
4162 49	130 A	160 A	400-440 V~	38240	1

150 A - Integrated auxiliary contacts 2 NO + 2 NC
Screw terminals

4162 60	150 A	210 A	24 V~	38760	1
4162 61	150 A	210 A	24 V=	41470	1
4162 62	150 A	210 A	48 V~	38760	1
4162 63	150 A	210 A	48 V=	41470	1

* MRP - Maximum Retail Price Inclusive of all taxes including GST.

3 Pole Contactors CTX³ 130 A To 800 A Industrial Contactors

Cat.Nos	Max. opt. current AC 3	Max. opt. current AC 1	Control voltage	MRP* ₹ / Unit	Pack
---------	------------------------	------------------------	-----------------	---------------	------

150 A - Integrated auxiliary contacts 2 NO + 2 NC
Screw terminals

4162 66	150 A	210 A	100-240 V~/=	38760	1
4162 69	150 A	210 A	400-440 ~A	38760	1

CTX³ 225

With integrated auxiliary contacts - Screw terminals

185 A - Integrated auxiliary contacts 2 NO + 2 NC

4162 80	185 A	230 A	24 V~/=	48930	1
4162 82	185 A	230 A	48 V~/=	48930	1
4162 86	185 A	230 A	100-240 V~/=	44120	1
4162 89	185 A	230 A	380-450 V~	44120	1

225 A - Integrated auxiliary contacts 2 NO + 2 NC

4162 90	225 A	275 A	24 V~/=	50500	1
4162 92	225 A	275 A	48 V~/=	50500	1
4162 96	225 A	275 A	100-240 V~/=	44650	1
4162 99	225 A	275 A	380-450 V~	44650	1

CTX³ 400

With integrated auxiliary contacts - Screw terminals

265 A - Integrated auxiliary contacts 2 NO + 2 NC

4163 06	265 A	300 A	100-240 V~/=	58550	1
4163 09	265 A	300 A	380-450 V~	58550	1

330 A - Integrated auxiliary contacts 2 NO + 2 NC

4163 16	330 A	350 A	100-240 V~/=	68290	1
4163 19	330 A	350 A	380-450 V~	68290	1

400 A - Integrated auxiliary contacts 2 NO + 2 NC

4163 26	400 A	450 A	100-240 V~/=	83530	1
4163 29	400 A	450 A	380-450 V~	83530	1

CTX³ 800

With integrated auxiliary contacts - Screw terminals

500 A - Integrated auxiliary contacts 2 NO + 2 NC

4163 36	500 A	580 A	200-240 V~/=	125520	1
4163 39	500 A	580 A	380-450 V~	125520	1

630 A - Integrated auxiliary contacts 2 NO + 2 NC

4163 46	630 A	660 A	200-240 V~/=	178730	1
4163 49	630 A	660 A	380-450 V~	178730	1

800 A - Integrated auxiliary contacts 2 NO + 2 NC

4163 56	800A	900 A	200-240 V~/=	266540	1
4163 59	800 A	900 A	380-450 V~	266540	1

Bold Cat.Nos are products normally available with Legrand (India) Stockists. Cat.Nos that are not bold - delivery within 4 - 8 weeks from the date of order. Bold packing quantity is our mandatory packing. Orders to be placed by Legrand (India) Stockist in multiples of the same.



4161 86



4162 96



4162 46



4163 56

Thermal Relays RTX³ For CTX³ 3 Pole Industrial Contactors

Cat.Nos	I min. (A)	I max. (A)	MRP* ₹ / Unit	Pack
---------	---------------	---------------	---------------------	------

Features

Conforms to IEC/EN 60947-4-1

CE & UL Certified

Thermal protection of circuits against overload, long starting times, and phase failure

Trip Class 10A

Trip Indication

Manual/Automatic Reset

Integrated Auxiliary Contacts 1 NO & 1 NC

Standard type:

- Overload detecting bimetal is used all for three phases

Differential type:

- Standard type characteristics + phase failure protection

Thermal Overload Relays

Class 10A - Integrated auxiliary contacts 1 NO + 1 NC

RTX³ 40 - for CTX³ 22 and 40

Standard type with screw terminals

Cat.Nos	I min. (A)	I max. (A)	MRP* ₹ / Unit	Pack
4166 40	0.1	0.16	2600	1
4166 41	0.16	0.25	2600	1
4166 42	0.25	0.4	2600	1
4166 43	0.4	0.63	2600	1
4166 44	0.63	1	2600	1
4166 45	1	1.6	2600	1
4166 46	1.6	2.5	2600	1
4166 47	2.5	4	2600	1
4166 48	4	6	2600	1
4166 49	5	8	2600	1

RTX³ 40 - for CTX³ 22 and 40

Standard type with screw terminals

Cat.Nos	I min. (A)	I max. (A)	MRP* ₹ / Unit	Pack
4166 50	6	9	2600	1
4166 51	7	10	2600	1
4166 52	9	13	2600	1
4166 53	12	18	2600	1
4166 54	16	22	2710	1
4166 55	18	25	2750	1
4166 56	22	32	3120	1
4166 57	28	40	3360	1

* MRP - Maximum Retail Price Inclusive of all taxes including GST.



4167 31



4167 65

Thermal Relays RTX³ For CTX³ 3 Pole Industrial Contactors

Cat.Nos	I min. (A)	I max. (A)	MRP* ₹ / Unit	Pack
---------	---------------	---------------	---------------------	------

RTX³ 40 - for CTX³ 22 and 40

Differential type with screw terminals

Cat.Nos	I min. (A)	I max. (A)	MRP* ₹ / Unit	Pack
4166 60	0.1	0.16	3170	1
4166 61	0.16	0.25	3170	1
4166 62	0.25	0.4	3170	1
4166 63	0.4	0.63	3210	1
4166 64	0.63	1	3210	1
4166 65	1	1.6	3210	1
4166 66	1.6	2.5	3210	1
4166 67	2.5	4	3210	1
4166 68	4	6	3220	1
4166 69	5	8	3220	1
4166 70	6	9	3220	1
4166 71	7	10	3220	1
4166 72	9	13	3220	1
4166 73	12	18	3370	1
4166 74	16	22	3370	1
4166 75	18	25	3370	1
4166 76	22	32	4110	1
4166 77	28	40	4110	1

RTX³ 65 - for CTX³ 65

Standard type with screw terminals

Cat.Nos	I min. (A)	I max. (A)	MRP* ₹ / Unit	Pack
4166 83	9	13	5230	1
4166 84	12	18	5230	1
4166 85	16	22	5230	1
4166 86	18	25	5230	1
4166 87	24	36	5230	1
4166 88	28	40	5230	1
4166 89	34	50	5230	1
4166 90	45	65	5230	1

RTX³ 100 - for CTX³ 100

Standard type with screw terminals

Cat.Nos	I min. (A)	I max. (A)	MRP* ₹ / Unit	Pack
4167 23	18	25	8460	1
4167 24	24	36	8460	1
4167 25	28	40	8460	1
4167 26	34	50	8460	1
4167 27	45	65	8460	1
4167 28	54	75	8460	1
4167 29	63	85	8460	1
4167 30	70	95	8460	1
4167 31	80	100	8460	1

RTX³ 150 - for CTX³ 150

Standard type with screw terminals

Cat.Nos	I min. (A)	I max. (A)	MRP* ₹ / Unit	Pack
4167 60	45	65	12450	1
4167 61	54	75	12450	1
4167 62	63	85	12450	1
4167 63	80	105	12450	1
4167 64	95	130	12450	1
4167 65	110	150	12450	1

Bold Cat.Nos are products normally available with Legrand (India) Stockists. Cat.Nos that are not bold - delivery within 4 - 8 weeks from the date of order. Bold packing quantity is our mandatory packing. Orders to be placed by Legrand (India) Stockist in multiples of the same.

Thermal Relays RTX³ For CTX³ 3 Pole Industrial Contactors

Cat.Nos	Description	MRP* ₹ / Unit	Pack
---------	-------------	------------------	------

Separate Mounting Units

To mount the relays separately from contactors, on DIN rail or panel by fixing screws

4165 91	For RTX ³ 40 up to 32 A	970	1
4165 92	For RTX ³ 40 40 A	970	1
4165 93	For RTX ³ 65 with screw terminals	1200	1
4165 94	For RTX ³ 65 with cage terminals	1200	1
4165 95	For RTX ³ 100 with screw terminals	1520	1
4165 96	For RTX ³ 100 with cage terminals	1520	1
4165 97	For RTX ³ 150 with screw terminals	2410	1
4165 98	For RTX ³ 150 with cage terminals	2410	1

Thermal Overload Relays

Class 10 A - Integrated auxiliary contacts 1 NO + 1 NC

Cat.Nos	I min. (A)	I max. (A)	MRP* ₹ / Unit	Pack
---------	------------	------------	------------------	------

RTX³ 225 - for CTX³ 225

Differential type with screw terminals

4167 80	65	100	16920	1
4167 81	85	125	16920	1
4167 82	100	160	18760	1
4167 83	120	185	18760	1
4167 84	160	240	19480	1



4167 84

RTX³ 400 - for CTX³ 400

Differential type with screw terminals

4167 86	85	125	24840	1
4167 87	100	160	24840	1
4167 88	120	185	24840	1
4167 89	160	240	24840	1
4167 90	200	330	24840	1
4167 91	260	400	24840	1

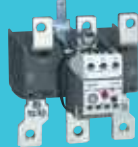

4167 91

RTX³ 800 - for CTX³ 800

Differential type with screw terminals

4167 92	200	300	38630	1
4167 93	260	400	38630	1
4167 94	400	630	38630	1
4167 95	520	800	38630	1



4164 36

4-pole contactors CTX³ 40 A to 900 A Industrial Contactors and Spare Coils

Cat.Nos	Max. opt. current AC 1	Max. opt. current AC 3	Control voltage	MRP* ₹ / Unit	Pack
---------	------------------------	------------------------	-----------------	------------------	------

Contactors CTX³

Power terminals: screw terminals

Without integrated auxiliary contact

4164 26	40 A	22 A	230 V~	4190	1
4164 36	60 A	40 A	230 V~	10420	1
4164 46	100 A	65 A	230 V~	17890	1
4164 56	135 A	85 A	230 V~	22010	1



4164 56

* MRP - Maximum Retail Price Inclusive of all taxes including GST.

4-Pole Contactors CTX³ 40 A to 900 A Industrial Contactors and Spare Coils

Cat.Nos	Max. opt. current AC 1	Max. opt. current AC 3	Control voltage	MRP* ₹ / Unit	Pack
---------	------------------------	------------------------	-----------------	------------------	------

With Integrated Auxiliary Contacts

Auxiliary contacts: 2 NO + 2 NC

4164 66	165 A	130 A	100-240 V~/=	36470	1
4164 76	250 A	150 A	100-240 V~/=	49010	1
4164 86	330 A	225 A	100-240 V~/=	54530	1
4164 96	420 A	330 A	100-240 V~/=	100830	1
4165 06	500 A	400 A	100-240 V~/=	110330	1
4165 16	750 A	630 A	200-240 V~/=	221780	1
4165 26	900 A	800 A	200-240 V~/=	268130	1



4164 86

Spare Coils for CTX³ 4P Contactors

Cat.Nos	Description	MRP* ₹ / Unit	Pack
---------	-------------	------------------	------

Control voltage 230 V~

4165 46	For CTX ³ 40 A to 60 A (AC-1)	2050	1
4165 56	For CTX ³ 100 A to 135 A (AC-1)	2440	1
4165 66	For CTX ³ 165 A to 330 A (AC-1)	12810	1
4165 76	For CTX ³ 420 A to 500 A (AC-1)	23930	1
4165 86	For CTX ³ 750 A to 900 A (AC-1)	35900	1

CTX³ Add-On Auxiliary Contact Blocks

Front Mounting

For CTX³ 3P form 9 A to 150 A (AC-3) and CTX³ 4P from 40 A to 135 A (AC-1) - 2 and 4 pole - lth: 16 A

4168 50	1 NO + 1 NC	650	10
4168 51	2 NO	650	10
4168 52	2 NC	650	10
4168 53	4 NO	1030	10
4168 54	3 NO + 1 NC	1030	10
4168 55	2 NO + 2 NC	1030	10
4168 56	1 NO + 3 NC	1030	10
4168 57	4 NC	1030	10



4168 50



4168 55

Side Mounting

2 pole - Mounting on both sides

4168 58	For CTX ³ 3P Form 9 A to 150 A (AC-3) 1 NO + 1 NC - lth: 16 A	1120	10
4168 59	For CTX ³ 3P Form 185 A to 800 A (AC-3) and CTX ³ 4P from 165 A to 900 A (AC-1) 1 NO + 1 NC - lth: 16 A	1120	10
4168 49	For CTX ³ 4P From 40 A to 135 A (AC-1) 1 NO + 1 NC - lth: 16 A	1120	10

Bold Cat.Nos are products normally available with Legrand (India) Stockists. Cat.Nos that are not bold - delivery within 4 - 8 weeks from the date of order. Bold packing quantity is our mandatory packing. Orders to be placed by Legrand (India) Stockist in multiples of the same.

4-Pole Contactors CTX³

40 A to 900 A Industrial Contactors and Spare Coils



Cat.Nos	Description	MRP* ₹ / Unit	Pack
---------	-------------	------------------	------

CTX³ Time Delay Blocks

For CTX³ 3P from 9 A to 150 A (AC-3)

Time delay: 1 to 30 s

Front mounting

On Delay

4168 70	24-48 V~/=	3000	1
4168 71	110-230 V~	3000	1

Off Delay

4168 72	24-48 V~/=	4110	1
4168 73	110-230 V~	3920	1

CTX³

capacitor Switching Units Cat.Nos 4168 74/75/76/77
Capacitor Unit Is Connected To The Terminals Of The Contactor To Reduce The High Inrush Current.

IEC 60947-4-1 AC 6b

Type	Contactor		Maximum operating power (kVAr)			Max. Peak current (A)
			220 - 240 V	400 - 480 V	500 - 550 V	
4168 74	CTX ³ 22	9 A	5	9.7	14	560
	CTX ³ 22	12 A	6.7	12.5	18	560
	CTX ³ 22	18 A	8.5	16.7	24	850
	CTX ³ 22	22 A	10	18	26	1250
	CTX ³ 40	32 A	15	25	36	1900
	CTX ³ 40	40 A	20	33.3	48	2160
4168 75/76	CTX ³ 65	50 A	20	40	58	2160
	CTX ³ 65	65 A	25	45.7	66	3040
4168 77	CTX ³ 100	75 A	29.7	54	78	3040
	CTX ³ 100	85 A	35	60	92	3040
	CTX ³ 100	100 A	37	62	94	3040
Without Capacitor Switching Unit as per IEC 60947-4-1 AC 6b	CTX ³ 150	150 A		70		3300
	CTX ³ 225	185 A		84	120	3500
	CTX ³ 225	225 A		115	130	4000
	CTX ³ 400	265 A		125	140	5000
	CTX ³ 400	330 A		139	185	6500
	CTX ³ 400	400 A		185	195	8000
	CTX ³ 800	500 A		220	330	10000
	CTX ³ 800	630 A		291	340	12000
	CTX ³ 800	800 A		369	370	14200

Note:

- When the switch is closed capacitor must be discharged before recharged. (Maximum residual voltage at terminals ≤ 50 V)
- To prevent short current, gG type fuse must be 1.5 - 2 times than rated current

* MRP - Maximum Retail Price Inclusive of all taxes including GST.

CTX³ Accessories

Cat.Nos	Description	MRP* ₹ / Unit	Pack
---------	-------------	------------------	------

CTX³ Capacitor Switching Units

AC-6b

Operating power from 9.7 kVAr to 62 kVAr (400/440 V)

4168 74	For contactors CTX ³ 3P from 9 to 40 A, upto 33.3 kVAr at 440 V / 48 kVAr at 525 V	2840	1
4168 75	For contactors CTX ³ 3P 50 and 65 A with screw terminals upto 45.7 kVAr at 440 V / 66 kVAr at 525 V	3870	1
4168 76	For contactors CTX ³ 3P 50 and 65 A with cage terminals upto 45.7 kVAr at 440 V / 66 kVAr at 525 V	4190	1
4168 77	For contactors CTX ³ 3P 75 to 100 A with screw terminals upto 62 kVAr at 440 V / 94 kVAr at 525 V	4190	1

CTX³ Interlocking

Component parts for assembling by customer
Horizontal mounting

Interlock Units

4168 79	Mechanical interlocks for CTX ³ 4P from 40 to 135 A (AC-1)	1700	5
---------	---	------	---

Interlock Units

4168 80	Mechanical interlocks for CTX ³ 3P from 9 to 150 A Provides 2 NC contacts for use in electrical interlocking	3450	1
4168 87	Mechanical interlocks for CTX ³ 3P from 185 to 400 A and CTX ³ 4P from 165 to 500 A	5980	1

Interlock Units

4168 88	Mechanical interlocks for CTX ³ 3P from 500 to 800 A	8000	1
4168 89	Mechanical interlocks for CTX ³ 4P from 750 to 900 A	8460	1

Wire Kits

Used for making reversing between two 3P contactors

4168 82	For CTX ³ 22	1750	5
4168 83	For CTX ³ 40	2360	5
4168 84	For CTX ³ 65	2900	5
4168 85	For CTX ³ 100	4860	5

Bold Cat.Nos are products normally available with Legrand (India) Stockists. Cat.Nos that are not bold - delivery within 4 - 8 weeks from the date of order. Bold packing quantity is our mandatory packing. Orders to be placed by Legrand (India) Stockist in multiples of the same.

CTX³ Accessories



4168 91



4168 97



4168 40

Cat.Nos	Description	MRP* ₹ / Unit	Pack
---------	-------------	------------------	------

Boxes for Motor Starter

For CTX³ 22 equipped with RTX³ 40 (0.1 - 22 A)

4168 90	Without pushbuttons	4440	1
4168 91	With pushbuttons	5440	1

CTX³ Transient Voltage Suppressor Blocks

Absorbs the surge arisen out of the coil of the contactor

4168 95	24-48 V~/=	860	10
4168 96	100-125 V~/=	860	10
4168 97	200-240 V~/=	860	10
4168 98	380-400 V~	860	10

CTX³ Terminals Covers

4168 42	For CTX ³ 3P from 185 to 225 A (AC-3)	780	5
4168 43	For CTX ³ 3P from 265 to 400 A (AC-3)	1160	5
4168 44	For CTX ³ 3P from 500 to 900 A (AC-3)	1760	5
4168 45	For CTX ³ 4P from 165 to 330 A (AC-1)	970	5
4168 46	For CTX ³ 4P from 420 to 500 A (AC-1)	1480	5
4168 47	For CTX ³ 4P from 750 to 900 A (AC-1)	2500	5

CTX³ Safety Front Cover

4168 40	For CTX ³ 3P from 9 to 150 A (AC-3) and CTX ³ 4P from 40 to 135 A (AC-1)	50	50
4168 41	For CTX ³ 3P from 85 to 800 A (AC-3) and CTX 4P from 165 to 900 A (AC-1)	200	50

Distant Reset Flexible Cables for Thermal Relays

4168 92	400 mm	1460	1
4168 93	500 mm	1590	1
4168 94	600 mm	1620	1

CTX³ spare coils

Spare Coils for CTX³ 3P Contactors

For CTX³ 22

4169 00	24 V~	1100	5
4169 02	48 V~	1100	5
4169 04	110 V~	1100	5
4169 06	230 V~	1100	5
4169 08	380 V~	1100	5
4169 09	415 V~	1100	5

* MRP - Maximum Retail Price Inclusive of all taxes including GST.
 ■ Price available on request.

CTX³ Accessories

Cat.Nos	Description	MRP* ₹ / Unit	Pack
---------	-------------	------------------	------

For CTX³ 40

4169 20	24 V~	1100	5
4169 21	24 V=	1100	5
4169 22	48 V~	1100	5
4169 23	48 V=	1100	5
4169 24	110 V~	1100	5
4169 26	230 V~	1100	5
4169 28	380 V~	1100	5
4169 29	415 V~	1100	5

For CTX³ 65

4169 30	24 V~	1690	5
4169 31	24 V=	1690	5
4169 32	48 V~	1690	5
4169 33	48 V=	1690	5
4169 34	110 V~	1690	5
4169 36	230 V~	1690	5
4169 38	380 V~	1690	5
4169 39	415 V~	1690	5

For CTX³ 100

4169 40	24 V~	2070	3
4169 41	24 V=	2070	3
4169 42	48 V~	2070	3
4169 43	48 V=	2070	3
4169 44	110 V~	2070	3
4169 46	230 V~	2070	3
4169 48	380 V~	2070	3
4169 49	415 V~	2070	3

For CTX³ 150

4169 50	24 V~	7820	1
4169 51	24 V=	7820	1
4169 52	48 V~	7820	1
4169 53	48 V=	7820	1
4169 56	100-240 V~/=	7820	1
4169 59	400-440 V~	7820	1

Bold Cat.Nos are products normally available with Legrand (India) Stockists. Cat.Nos that are not bold - delivery within 4 - 8 weeks from the date of order. Bold packing quantity is our mandatory packing. Orders to be placed by Legrand (India) Stockist in multiples of the same.

Auxillary Contactor / Control Relays CTX³



4169 66

Cat.Nos	Description	MRP* ₹ / Unit	Pack
---------	-------------	------------------	------

For CTX³ 225

4169 60	24 V~/=	11320	1
4169 62	48 V~/=	11320	1
4169 66	100-240 V~/=	11320	1
4169 69	400-440 V~	11320	1

For CTX³ 400

4169 76	100-240 V~/=	17020	1
4169 79	380-450 V~	17020	1

For CTX³ 800

4169 86	200-240 V~/=	37050	1
4169 89	380-450 V~	37050	1

Auxillary Contactor / Control Relays CTX³

4 pole

Conform to IEC 60 947-1, IEC 60 947-4-1 and IEC 60 947-5-1 for the auxiliary contacts

CE & UL Certified

Ultra High Ith = 10 A

Ultra Low consumption coil

Click fit accessories

Spare Coils available

RoHS Complaint

CTX³ Control Relays

4 NO

4168 00	24 V~	2220	1
4168 01	24 V=	3370	1
4168 02	48 V~	2220	1
4168 03	48 V=	3370	1
4168 04	110 V~	2220	1
4168 06	230 V~	2220	1
4168 09	415 V~	2220	1

3 NO + 1 NC

4168 10	24 V~	2220	1
4168 11	24 V=	3370	1
4168 12	48 V~	2220	1
4168 13	48 V=	3370	1
4168 14	110 V~	2220	1
4168 16	230 V~	2220	1
4168 19	415 V~	2220	1



4168 10

Accessories for Auxiliary Contactor / Control Relays

Cat.Nos	Description	MRP* ₹ / Unit	Pack
---------	-------------	------------------	------

2 NO + 2 NC

4168 20	24 V~	2220	1
4168 21	24 V=	3400	1
4168 22	48 V~	2220	1
4168 23	48 V=	3370	1
4168 24	110 V~	2220	1
4168 26	230 V~	2220	1
4168 29	415 V~	2220	1

High Thermal Current - 10 A

Ith : 10 A

Front Mounting

4171 50	1 NO + 1 NC	610	10
4171 51	2 NO	610	10
4171 52	2 NC	610	10
4171 53	4 NO	940	10
4171 54	3 NO + 1 NC	940	10
4171 55	2 NO + 2 NC	940	10
4171 56	1 NO + 3 NC	940	10
4171 57	4 NC	940	10

Side Mounting

4171 58	1 NO	610	10
4171 59	1 NC	610	10

Interlock Unit

4171 60	Mechanical Interlock	980	5
---------	----------------------	-----	---

Spare Coils

4171 70	24 V~	1090	5
4171 71	24 V=	1480	5
4171 74	110 V~	1090	5
4171 76	230 V~	1090	5
4171 79	415 V~	1090	5

* MRP - Maximum Retail Price Inclusive of all taxes including GST.

Bold Cat.Nos are products normally available with Legrand (India) Stockists. Cat.Nos that are not bold - delivery within 4 - 8 weeks from the date of order. **Bold packing quantity** is our mandatory packing. Orders to be placed by Legrand (India) Stockist in multiples of the same.

CX³

EMS (Energy Management System)

Smart Energy Management, Simplified



CX³ EMS is a compact modular system for local or remote monitoring and control of electrical installations.

Features

- Energy measurement for single & three-phase networks
- Modbus RS-485 & Ethernet communication

Benefits

- Better energy visibility and cost control
- Improved operational reliability with real-time alerts



Scan to know more about the product.

CX³ Contactors

Cat.Nos	Description	MRP* ₹ / Unit	Pack
---------	-------------	------------------	------

Power Contactors CX³

Conform to IEC/EN 61095
Space for power supply busbar on top (up to 25 A)

4125 44	25 A 2 NO contactor	3260	1
4125 45	40 A 2 NO contactor	5560	1
4125 47	63 A 2 NO contactor	6470	1
4125 48	63 A 2 NC contactor	6470	1
4125 49	40 A 3 NO contactor	9300	1
4125 50	63 A 3 NO contactor	10500	1
4125 51	25 A 4 NO contactor	3840	1
4125 53	40 A 4 NO contactor	9810	1
4125 56	63 A 4 NO contactor	11610	1
4125 57	63 A 4 NC contactor	11720	1

Signalling Auxiliaries For Contactors Auxiliary Changeover Switch

4124 29	For 1 module contactors 16 A to 25 A	4770	1
4124 30	For 2 module contactors 25 A	4790	1

* MRP - Maximum Retail Price Inclusive of all taxes including GST.



4173 08

MPCBs MPX³

Cat.Nos	Rated 3Ph Motor	Magnetic release operating current (A)	MRP* ₹ / Unit	Pack
---------	-----------------------	---	---------------------	------

Motor Protection Circuit Breakers From 0.16 A To 100 A Upto 45 KW

Maximum Efficiency In A Compact Unit

Conform to IEC 60947-1, IEC 60947-2, IEC 60947-4

Adjustable thermal release

Magnetic Release 13 le max

High breaking capacity

toggle handle

Fixing on rail or by screw

Wide Range Of Accessories

Undervoltage Release

Shunt Release

Auxiliary Contacts

IP 65 Enclosure

Thermal Magnetic MPCBs

Adjustable thermal release Magnetic release 13 le max.

MPX³ 32S - 3P

Standard breaking capacity with toggle handle

Fixing on rail □

415 V breaking capacity Icu (kA) - 100

Cat.Nos	Rated 3Ph Motor (KW)	Thermal release adj. range (A)	Magnetic release operating current (A)	MRP* ₹ / Unit	Pack
4173 00	0.02	0.1 to 0.16	2.1	5120	1
4173 01	0.06	0.16 to 0.25	3.3	5120	1
4173 02	0.09	0.25 to 0.4	5.2	5120	1
4173 03	0.12	0.4 to 0.63	8.2	5960	1
4173 04	0.18 / 0.25	0.63 to 1	13	5960	1
4173 05	0.37 / 0.55	1 to 1.6	20.8	5990	1
4173 06	0.75	1.6 to 2.5	32.5	6110	1
4173 07	1.5	2.5 to 4	52	6210	1
4173 08	2.2	4 to 6	78	6240	1
4173 09	3	5 to 8	104	6240	1

415 V breaking capacity Icu (kA) - 50

4173 10	4	6 to 10	130	6240	1
4173 11	5.5	9 to 13	169	6300	1

415 V breaking capacity Icu (kA) - 20

4173 12	7.5	11 to 17	221	7410	1
---------	-----	----------	-----	------	---

415 V breaking capacity Icu (kA) - 15

4173 13	7.5	14 to 22	286	7870	1
4173 14	11	18 to 26	338	8460	1
4173 15	15	22 to 32	416	14050	1

Bold Cat.Nos are products normally available with Legrand (India) Stockists. Cat.Nos that are not bold - delivery within 4 - 8 weeks from the date of order. **Bold packing quantity** is our mandatory packing. Orders to be placed by Legrand (India) Stockist in multiples of the same.

MPCBs MPX³

Cat.Nos	Description	MRP* ₹ / Unit	Pack
---------	-------------	---------------------	------

MPX³ 32H - 3P

High breaking capacity with rotary handle
415 V breaking capacity Icu (kA) - 100

4173 20	0.02	0.1 to 0.16	2.1	6320	1
4173 21	0.06	0.16 to 0.25	3.3	6320	1
4173 22	0.09	0.25 to 0.4	5.2	6320	1
4173 23	0.12	0.4 to 0.63	8.2	6950	1
4173 24	0.18 / 0.25	0.63 to 1	13	6950	1
4173 25	0.37 / 0.55	1 to 1.6	20.8	6950	1
4173 26	0.75	1.6 to 2.5	32.5	6950	1
4173 27	1.5	2.5 to 4	52	7160	1
4173 28	2.2	4 to 6	78	7190	1
4173 29	3	5 to 8	104	7760	1
4173 30	4	6 to 10	130	7840	1
4173 31	5.5	9 to 13	169	8610	1

415 V breaking capacity Icu (kA) - 50

4173 32	7.5	11 to 17	221	9220	1
4173 33	7.5	14 to 22	286	10790	1
4173 34	11	18 to 26	338	10880	1
4173 35	15	22 to 32	416	16900	1

MPX³ 63H - 3P

High breaking capacity with rotary handle
Fixing on rail or by screw
415 V breaking capacity Icu (kA) - 100

4173 60	4	6 to 10	130	16400	1
4173 61	5.5	9 to 13	169	16400	1

415 V breaking capacity Icu (kA) - 50

4173 62	7.5	11 to 17	221	16400	1
4173 63	7.5	14 to 22	286	18590	1
4173 64	11	18 to 26	338	18590	1
4173 65	15	22 to 32	416	18590	1
4173 66	18.5	28 to 40	520	20770	1
4173 67	22	34 to 50	650	25510	1
4173 68	30	45 to 63	819	27220	1

MPX³ 100H - 3P

High breaking capacity with rotary handle
Fixing on rail or by screw
415 V breaking capacity Icu (kA) - 100

4173 70	7.5	11 to 17	221	22670	1
4173 71	7.5	14 to 22	286	22670	1
4173 72	11	18 to 26	338	26940	1



4173 79



4173 48



4174 00

MPCBs MPX³

Cat.Nos	Description	MRP* ₹ / Unit	Pack
---------	-------------	---------------------	------

Used to connect MPX³ directly with the contactor

4173 73	15	22 to 32	416	22670	1
4173 74	18.5	28 to 40	520	22670	1
4173 75	22	34 to 50	650	26940	1
4173 76	30	45 to 63	819	28250	1

415 V breaking capacity Icu (kA) - 75

4173 77	37	55 to 75	975	30360	1
4173 78	45	70 to 90	1170	30360	1
4173 79	45	80 to 100	1300	30360	1

Magnetic only MPCBs

Without thermal release
Magnetic release 13 x Ie max.

MPX³ 32MA - 3P

High breaking capacity with rotary handle
Fixing on rail
415 V breaking capacity Icu (kA) - 100

4173 40	0.02	2.1	5790	1
4173 41	0.06	3.3	5790	1
4173 42	0.09	5.2	5790	1
4173 43	0.12	8.2	6450	1
4173 44	0.18 / 0.25	13	6450	1
4173 45	0.37 / 0.55	20.8	6450	1
4173 46	0.75	32.5	6450	1
4173 47	1.5	52	6540	1
4173 48	2.2	78	6540	1
4173 49	3	104	6540	1
4173 50	4	130	6890	1
4173 51	5.5	169	7330	1

415 V breaking capacity Icu (kA) - 50

4173 52	7.5	221	9430	1
4173 53	7.5	286	9430	1
4173 54	11	338	9430	1
4173 55	15	416	15590	1

MPCBs MPX³ Accessories

Cat.Nos	Description	MRP* ₹ / Unit	Pack
---------	-------------	---------------------	------

Auxiliary Contacts

2 pole

Side Mounting

Mounting on the left side of MPCBs
Two auxiliary contacts per MPCB

4174 00	1 NO + 1 NC	1240	5
4174 01	2 NO	1240	5
4174 02	2 NC	1240	5

Front mounting

One auxiliary contact per MPCB

4174 03	1 NO + 1 NC	1270	5
4174 04	2 NO	1270	5
4174 05	2 NC	1270	5

* MRP - Maximum Retail Price Inclusive of all taxes including GST.

Bold Cat.Nos are products normally available with Legrand (India) Stockists.
Cat.Nos that are not bold - delivery within 4 - 8 weeks from the date of order.
Bold packing quantity is our mandatory packing. Orders to be placed by Legrand (India) Stockist in multiples of the same.

MPCBs MPX³ Accessories

Cat.Nos	Description	MRP* ₹ / Unit	Pack
---------	-------------	---------------------	------

Alarm Contacts

1 NO + 1 NC

Any Trip Alarm Contact

Operates in case of trip

Mounting on the left side of MPCBs

Set alarm contact first in case of using auxiliary contact together (MPX³ 63H can not accept auxiliary contact and alarm contact together)

4174 06	For MPX ³ 32	2010	1
4174 08	For MPX ³ 63 and 100	2010	1

Magnetic Trip Alarm Contact

Operates in case of instantaneous trip

Mounting on the left side of MPCBs

Set alarm contact first in case of using auxiliary contact together

4174 07	1 NO + 1 NC	2010	1
---------	-------------	------	---

Shunt Release

Mounting On The Right Side Of MPCBs

One release per MPCB

4174 10	24 V~ 50 Hz / 28 V~ 60 Hz	3190	1
4174 11	110 V~ 50 Hz / 120 V~ 60 Hz	3190	1
4174 12	220-230 V~ 50 Hz / 240-260 V~ 60 Hz	3190	1
4174 13	380-400 V~ 50 Hz / 440-460 V~ 60 Hz	3190	1



4174 12

Undervoltage Release

Mounting On The Right Side Of MPCBs

One release per MPCB

Without Auxiliary Contact

4174 20	24 V~ 50 Hz / 28 V~ 60 Hz	3190	1
4174 21	110 V~ 50 Hz / 120 V~ 60 Hz	3190	1
4174 22	220-230 V~ 50 Hz / 240-260 V~ 60 Hz	3190	1
4174 23	380-400 V~ 50 Hz / 440-460 V~ 60 Hz	3190	1



4174 22

* MRP - Maximum Retail Price Inclusive of all taxes including GST.

MPCBs MPX³ Accessories

Cat.Nos	Description	MRP* ₹ / Unit	Pack
---------	-------------	---------------------	------

With 2 NO Auxiliary Contacts

Can not attach to MPX³ 32S

4174 30	24 V~ 50 Hz / 28 V~ 60 Hz	4250	1
4174 31	110 V~ 50 Hz / 120 V~ 60 Hz	4250	1
4174 32	220-230 V~ 50 Hz / 240-260 V~ 60 Hz	4250	1
4174 33	380-400 V~ 50 Hz / 440-460 V~ 60 Hz	4250	1

Dial Cover

Sealable cover to protect the set value from the operation that is not intended

Without Auxiliary Contact

4174 79	For all types of MPX ³	140	50
---------	-----------------------------------	-----	----

Direct Adaptor and Mounting unit

For mounting CTX³ contactors under MPX³ MPCBs

Direct Adaptors

Used to connect MPX³ directly with the contactor

4174 40	For MPX ³ 32S with CTX ³ mini AC	740	2
4174 41	For MPX ³ 32S with CTX ³ mini DC	740	2
4174 42	For MPX ³ 32H/32MA with CTX ³ mini AC	740	2
4174 43	For MPX ³ 32H/32MA with CTX ³ mini DC	740	2
4174 48	For MPX ³ 32S with CTX ³ 22 AC	890	2
4174 49	For MPX ³ 32S with CTX ³ 22 DC	890	2
4174 50	For MPX ³ 32H/32MA with CTX ³ 22 AC	890	2

Bold Cat.Nos are products normally available with Legrand (India) Stockists. Cat.Nos that are not bold - delivery within 4 - 8 weeks from the date of order. **Bold packing quantity** is our mandatory packing. Orders to be placed by Legrand (India) Stockist in multiples of the same.

MPCBs MPX³ Accessories

Cat.Nos	Description	MRP* ₹ / Unit	Pack
---------	-------------	---------------------	------

Direct Adaptors

Used To Connect MPX³ Directly with the Contactor

4174 51	For MPX ³ 32H/32MA with CTX ³ 22 DC	890	2
4174 52	For MPX ³ 32S with CTX ³ 40 AC	1090	2
4174 53	For MPX ³ 32S with CTX ³ 40 DC	1090	2
4174 54	For MPX ³ 32H/32MA with CTX ³ 40 AC	1090	2
4174 55	For MPX ³ 32H/32MA with CTX ³ 40 DC	1090	2
4174 56	For MPX ³ 63H with CTX ³ 65 AC with cage type terminals	1300	2
4174 57	For MPX ³ 63H with CTX ³ 65 DC with cage type terminals	1300	2
4174 58	For MPX ³ 100H with CTX ³ 100 AC with cage type terminals	1300	1
4174 59	For MPX ³ 100H with CTX ³ 100 DC with cage type terminals	1300	1

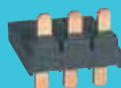

4174 56



4174 61

Mounting Unit

This device is used for joining together MPX³ MCPBs and CTX³ contactors

4174 60	For MPX ³ 32S/32H/32MA	1010	2
4174 61	For MPX ³ 63H	1850	1
4174 62	For MPX ³ 100H	2230	1

MPCBs MPX³ Accessories

Cat.Nos	Description	MRP* ₹ / Unit	Pack
---------	-------------	---------------------	------

Rotary Handle

Mounting On Panel's Door To Control The MPX³

4174 63	For MPX ³ 32H and 32 MA	2630	1
4174 64	For MPX ³ 63H	2630	1
4174 65	For MPX ³ 100H	3330	1



4174 63

Phase Busbar

For Parallel Connection of MPX³

For MPX³ 32S, 32H and 32MA

Rated Current 63 A

4174 71	2 devices	1040	5
4174 73	3 devices	2600	5
4174 75	4 devices	2600	5
4174 76	5 devices	2600	5
4174 77	Feeder for phase busbar 32 A	720	5



4174 73

For MPX³ 63H

Rated Current 108 A

4174 72	2 devices	1850	5
4174 74	3 devices	2780	5

Enclosures for MPX³ 32H and 32MA

IP 65 enclosure to use in dusty areas as well as in presence of corrosive gas or liquid

4174 80	Yellow/red with rotary handle	2150	5
4174 81	With black rotary handle	2780	5



4174 81

* MRP - Maximum Retail Price Inclusive of all taxes including GST.

Bold Cat.Nos are products normally available with Legrand (India) Stockists. **Cat.Nos that are not bold** - delivery within 4 - 8 weeks from the date of order. **Bold packing quantity** is our mandatory packing. Orders to be placed by Legrand (India) Stockist in multiples of the same.

Alpx³

Capacitors

Reliable and Efficient Power Factor Correction with Alpx³



Alpx³ is a premium range of power capacitors designed for reliable reactive power compensation in modern electrical installations. With robust construction, compact design, and high-quality components, they ensure efficient performance and long service life even in networks with demanding harmonic conditions.

Features

- Self-healing capacitor technology
- Suitable for networks with harmonic distortion
- Compact design for easy panel integration
- Low-loss construction for improved efficiency

Benefits

- Reduces electricity costs by improving power factor
- Increases system capacity by freeing transformer and cable kVA
- Improves voltage stability for better equipment performance
- Enhances overall system efficiency and reliability



Scan to know more about the product.



Alpx³ Resin Filled Capacitors

Cat.Nos	Description	MRP* ₹ / Unit	Pack
---------	-------------	---------------------	------

Confirms to IS13340-1&2 , IEC60831-1&2
ISI Mark
Compact Design
Self healing metallized polypropylene film
Over pressure device for disconnection
Low energy losses
Resistance to high temperature
Resin filled

Can be used in system with <= 10% THDi

Standard Duty Can-Type 440 V

5150 00	1 kVAr Resin std duty 440 V	410	1
5150 01	2 kVAr Resin std duty 440 V	860	1
5150 02	3 kVAr Resin std duty 440 V	1230	1
5150 03	4 kVAr Resin std duty 440 V	1720	1
5150 04	5 kVAr Resin std duty 440 V	2010	1
5150 05	7.5 kVAr Resin std duty 440 V	2960	1
5150 06	10 kVAr Resin std duty 440 V	3950	1
5150 07	12.5 kVAr Resin std duty 440	4940	1
5150 08	15 kVAr Resin std duty 440 V	5920	1
5150 09	20 kVAr Resin std duty 440 V	7750	1
5150 10	25 kVAr Resin std duty 440 V	9780	1
5150 11	30 kVAr Resin std duty 440 V	11790	1



5150 04



5150 06

Standard Duty Can-Type 480 V

5150 24	4.2 kVAr Resin 480 V	3030	1
5150 25	6.9 kVAr Resin 480 V	4880	1
5150 26	8.7 kVAr Resin 480 V	6180	1
5150 27	10.4 kVAr Resin 480 V	7430	1
5150 28	14 kVAr Resin 480 V	9900	1
5150 29	17.4 kVAr Resin 480 V	11720	1
5150 30	20.8 kVAr Resin 480 V	13930	1

Alpx³ Resin Filled Capacitors

Cat.Nos	Description	MRP* ₹ / Unit	Pack
---------	-------------	---------------------	------

Standard Duty Can-Type 525 V

5150 31	5 kVAr Resin 525 V	3600	1
5150 32	8.3 kVAr Resin 525 V	6180	1
5150 33	10.4 kVAr Resin 525 V	7440	1
5150 34	12.5 kVAr Resin 525 V	9140	1
5150 35	16.7 kVAr Resin 525 V	11540	1
5150 36	20.8 kVAr Resin 525 V	14760	1
5150 37	25 kVAr Resin 525 V	17280	1

Standard Duty Box-Type 440 V

5150 40	1 kVAr Std box Capacitor 440 V	550	1
5150 41	2 kVAr Std box Capacitor 440 V	1100	1
5150 42	3 kVAr Std box Capacitor 440 V	1660	1
5150 43	4 kVAr Std box Capacitor 440 V	2210	1
5150 44	5 kVAr Std box Capacitor 440 V	2720	1
5150 45	7.5 kVAr Std box Capacitor 440 V	4010	1
5150 46	8.33 kVAr Std box Capacitor 440 V	4520	1
5150 47	10 kVAr Std box Capacitor 440 V	5350	1
5150 48	12.5 kVAr Std box Capacitor 440 V	6690	1
5150 49	15 kVAr Std box Capacitor 440 V	8020	1
5150 50	20 kVAr Std box Capacitor 440 V	10500	1
5150 51	25 kVAr Std box Capacitor 440 V	13120	1
5150 52	50 kVAr Std box Capacitor 440 V	27250	1



5150 47

* MRP - Maximum Retail Price Inclusive of all taxes including GST.

Bold Cat.Nos are products normally available with Legrand (India) Stockists. **Cat.Nos that are not bold** - delivery within 4 - 8 weeks from the date of order. **Bold packing quantity** is our mandatory packing. Orders to be placed by Legrand (India) Stockist in multiples of the same.

Reactors

Cat.Nos	Description	MRP* ₹ / Unit	Pack
---------	-------------	------------------	------

Can be used in system with <= 15% THDi

Heavy Duty Can-Type 440 V

5150 12	1 kVAr Resin heavy duty 440 V	780	1
5150 13	2 kVAr Resin heavy duty 440 V	1630	1
5150 14	3 kVAr Resin heavy duty 440 V	2340	1
5150 15	4 kVAr Resin heavy duty 440 V	3250	1
5150 16	5 kVAr Resin heavy duty 440 V	3510	1
5150 17	7.5 kVAr Resin heavy duty 440	5270	1
5150 18	10 kVAr Resin heavy duty 440	6890	1
5150 19	12.5 kVAr Resin heavy duty 44	8620	1
5150 20	15 kVAr Resin heavy duty 440	10350	1
5150 21	20 kVAr Resin heavy duty 440	13280	1
5150 22	25 kVAr Resin heavy duty 440	16600	1
5150 23	30 kVAr Resin heavy duty 440	20010	1



5150 23

Reactors

Cat.Nos	Description	MRP* ₹ / Unit	Pack
---------	-------------	------------------	------

Heavy Duty Box-Type 440 V

5150 53	5 kVAr HD box 440 V	4300	1
5150 54	7.5 kVAr HD box 440 V	6280	1
5150 55	8.33 kVAr HD box 440 V	6950	1
5150 56	10 kVAr HD box 440 V	8370	1
5150 57	12.5 kVAr HD box 440 V	10470	1
5150 58	15 kVAr HD box 440 V	12560	1
5150 59	20 kVAr HD box 440 V	15940	1
5150 60	25 kVAr HD box 440 V	19930	1
5150 61	50 kVAr HD box 440 V	39850	1



5150 61



4151 50

Reactors 7 % Duty

4151 48	Reactor 10 kVAr	22350	1
4151 49	Reactor 12.5 kVAr	29270	1
4151 50	Reactor 25 kVAr	37260	1
4151 51	Reactor 50 kVAr	60610	1
4151 52	Reactor 100 kVAr	121400	1

Reactors 14 % Duty

4151 53	Reactor 12.5 kVAr	39500	1
4151 54	Reactor 25 kVAr	65830	1
4151 55	Reactor 50 kVAr	87040	1

Power Factor Controller Eco

4151 95	4 step controller	26310	1
4151 96	6 step controller	23860	1
4151 97	8 step controller	26760	1
4151 98	12 step controller	31820	1

* MRP - Maximum Retail Price Inclusive of all taxes including GST.

Warranty

- The Company, at its discretion, will replace products if they have any manufacturing defect within 1 years for capacitor, Reactor & APFC controller.
- The above guarantee is applicable when the products are selected taken into consideration all the technical characteristics of the product published in our catalogue.
- The guarantee is only applicable when the products are installed as per the Company's instructions and not tampered in any manner.
- The guarantee states the Company's entire liability. It does not extend to cover consequential loss or damage or installation costs arising from defective products.

Alpx³ range of capacitor - Selection Chart

DETERMINING THE CAPACITOR BANK TYPE ACCORDING TO THE LEVEL OF HARMONICS

For supplies with a high level of harmonic pollution, Legrand recommends capacitor banks with detuned reactors.

The detuned reactor performs a threefold role:



- Increasing the capacitor impedance in relation to the harmonic currents
- Shifting the parallel resonance frequency (Fr.p) of the source and capacitor to below the main frequencies of the harmonic currents that are causing interference.

Tuning frequency (Hz)	Blocking factor (P%)	Tuning number (n)
189	7	3.78
135	14	2.7

- Helping to reduce harmonic levels in the supply.

The table opposite can be used to select the capacitor bank type according to the degree of harmonic pollution, by measuring the percentage of THDi and THDu or by estimating the percentage total power of SH/ST non-linear loads.

Measurements		Estimates	Type of capacitor to be used	Reactor to be used
THDU %	THDI %	SH/ST %		
≤ 3	≤ 10	≤ 15	Standard Duty	-
≤ 4	≤ 15	≤ 25	Heavy Duty	-
≤ 6	≤ 30	≤ 35	Standard Duty	7% Reactor *14% Reactor if high level of 3rd order harmonics
≤ 8	≤ 40	≤ 50	Heavy Duty	7% Reactor

SH (kVA) is the weighted total power of the harmonic generators present at the transformer secondary.

ST (kVA) is the power rating of the HV/LV transformer.

THDi = Total Harmonic Distortion (THD) is the ratio of the rms value of the harmonic currents In of the order n to the rms value of the fundamental.

THDu = Voltage Distortion (THDu) is caused mainly by the high level of Current Distortion (THDi) and the level of THDu is dependent on the source impedance.

* for example if -

- Ih5 > 0.2x145
- Ih3 : 3rd order harmonic currents
- Ih5 : 5th order harmonic currents

Note: These statements are based on our knowledge of typical application. We clearly point out that these statements cannot be regarded as binding statements about the suitability of our products for a particular customer application. It is necessary that the customer should check and decide whether the product is suitable for use in a particular application.

DX³

Modular Protection Devices

Complete Protection for Residential, Commercial & Industrial Applications



DX³ protective devices deliver a comprehensive circuit protection solution built for modern electrical systems. Designed to support efficient panel building and consistent performance, they provide a dependable foundation for safe and streamlined electrical distribution across diverse applications.

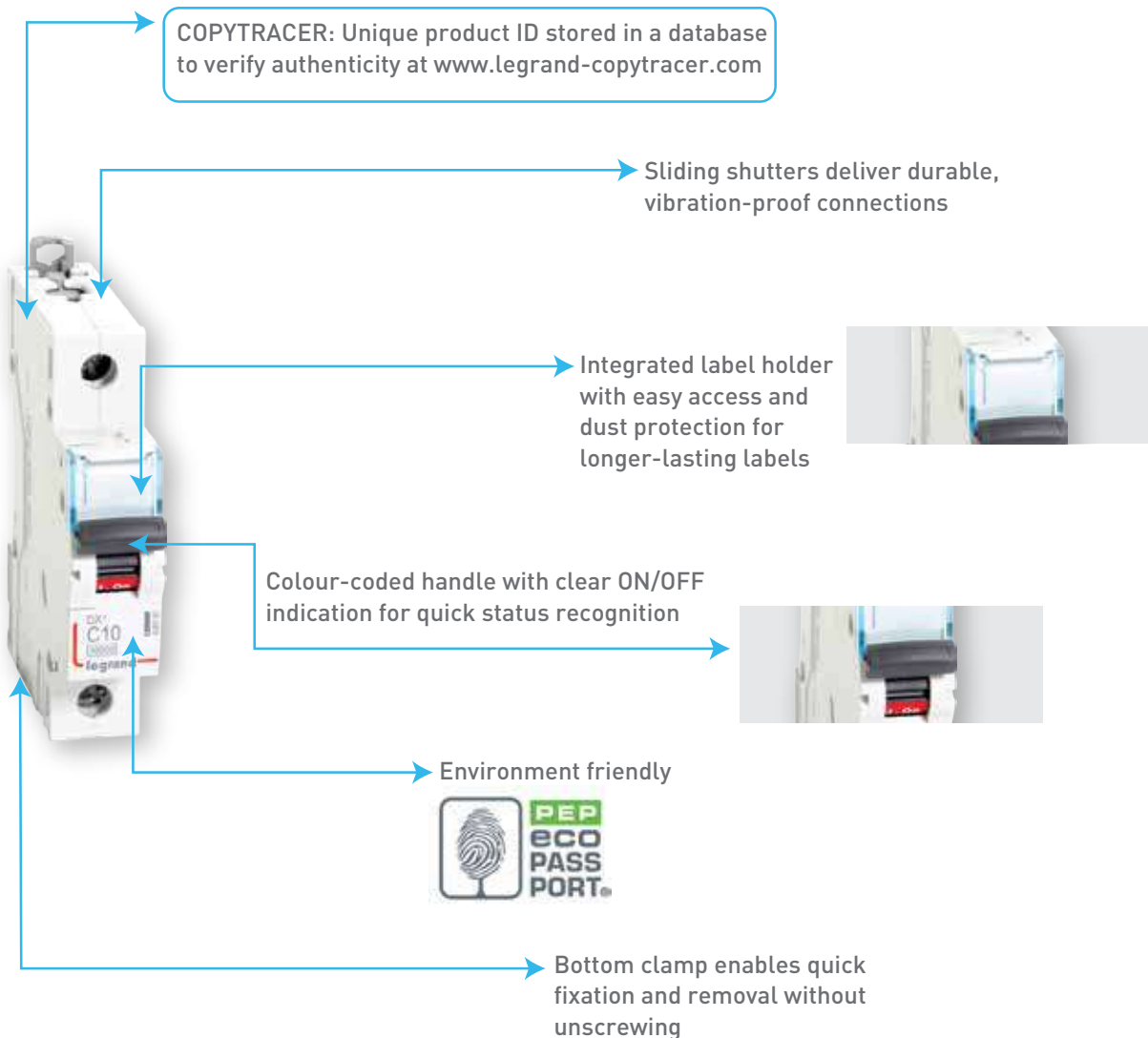

Range

The DX³ range has a selection of electrical auxiliaries for monitoring and controlling circuits remotely

Auxiliary contacts and fault signal contacts, shunt trips, undervoltage releases, motorised controls and automatic reclosers.

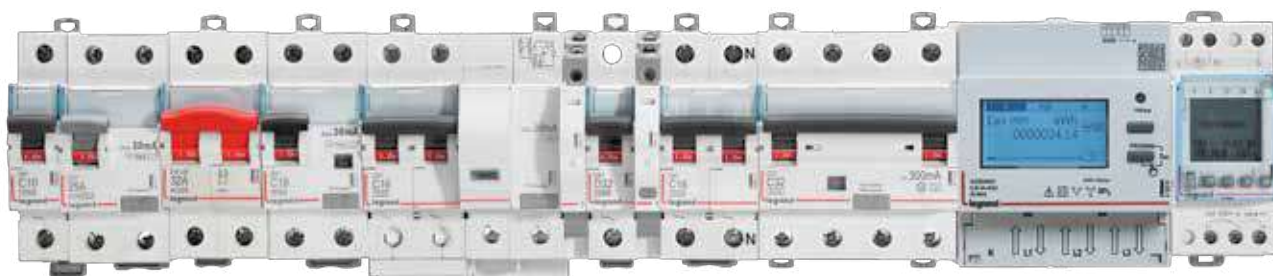

Scan to know more about the product.



DX³ AC MCBs

Cat.Nos	Nominal Rating	Number of 17.5 mm modules	MRP* ₹ / Unit	Pack
---------	----------------	---------------------------	---------------	------

MCBs for AC Applications till 63A

10 kA ISI marked as per IS/IEC 60898-1 2002
 Integrated label holder
 Sliding bottom clamp
 Efficient air channels
 Color coded On/Off indication on dolly
 Biconnect lower terminals
 IP 20 protected terminals
 Sliding shutters
 Compatible with signal and control Auxiliaries

DC-80 V per pole - 1 kA

C Curve

Single Pole 240/410V

4085 80	0.5	1	736	1/10/120
4085 81	1	1	736	1/10/120
4085 83	2	1	729	1/10/120
4085 84	3	1	729	1/10/120
4085 85	4	1	729	1/10/120
4085 87	6	1	449	1/10/120
4085 90	10	1	449	1/10/120
4085 92	16	1	449	1/10/120
4085 93	20	1	449	1/10/120
4085 94	25	1	449	1/10/120
4085 95	32	1	449	1/10/120
4085 96	40	1	1026	1/10/120
4085 97	50	1	1026	1/10/120
4085 98	63	1	1026	1/10/120



4085 90

Single Pole + Neutral 240V

4086 02	0.5	2	1925	1/5/60
4086 03	1	2	1925	1/5/60
4086 05	2	2	1925	1/5/60
4086 06	3	2	1925	1/5/60
4086 07	4	2	1925	1/5/60
4086 09	6	2	1362	1/5/60
4086 12	10	2	1362	1/5/60
4086 14	16	2	1362	1/5/60
4086 15	20	2	1362	1/5/60
4086 16	25	2	1362	1/5/60
4086 17	32	2	1362	1/5/60
4086 18	40	2	2203	1/5/60
4086 19	50	2	2203	1/5/60
4086 20	63	2	2203	1/5/60



4086 14

DX³ AC MCBs

Cat.Nos	Nominal Rating	Number of 17.5 mm modules	MRP* ₹ / Unit	Pack
---------	----------------	---------------------------	---------------	------

Double Pole 415V

4086 21	0.5	2	1999	1/40
4086 22	1	2	1999	1/40
4086 24	2	2	1999	1/40
4086 25	3	2	1999	1/40
4086 26	4	2	1999	1/40
4086 28	6	2	1472	1/40
4086 31	10	2	1472	1/40
4086 33	16	2	1472	1/40
4086 34	20	2	1472	1/40
4086 35	25	2	1472	1/40
4086 36	32	2	1472	1/40
4086 37	40	2	2316	1/40
4086 38	50	2	2316	1/40
4086 39	63	2	2316	1/40



4086 37

Triple Pole 415V

4086 43	0.5	3	2944	1/32
4086 44	1	3	2944	1/32
4086 46	2	3	2944	1/32
4086 47	3	3	2944	1/32
4086 48	4	3	2944	1/32
4086 50	6	3	2387	1/32
4086 53	10	3	2387	1/32
4086 55	16	3	2387	1/32
4086 56	20	3	2387	1/32
4086 57	25	3	2387	1/32
4086 58	32	3	2387	1/32
4086 59	40	3	3623	1/32
4086 60	50	3	3623	1/32
4086 61	63	3	3623	1/32



4086 55

Triple Pole + Neutral 415V

4086 65	0.5	4	3735	1/32
4086 66	1	4	3735	1/32
4086 68	2	4	3735	1/32
4086 69	3	4	3735	1/32
4086 70	4	4	3735	1/32
4086 72	6	4	3112	1/32
4086 75	10	4	3112	1/32
4086 77	16	4	3112	1/32
4086 78	20	4	3112	1/32
4086 79	25	4	3112	1/32
4086 80	32	4	3112	1/32
4086 81	40	4	4451	1/32
4086 82	50	4	4451	1/32
4086 83	63	4	4451	1/32



4086 77

* MRP - Maximum Retail Price Inclusive of all taxes including GST.

Bold Cat.Nos are products normally available with Legrand (India) Stockists. Cat.Nos that are not bold - delivery within 4 - 8 weeks from the date of order. Bold packing quantity is our mandatory packing. Orders to be placed by Legrand (India) Stockist in multiples of the same.

DX³ AC MCBs

Cat.Nos	Nominal Rating	Number of 17.5 mm modules	MRP* ₹ / Unit	Pack
---------	----------------	---------------------------	------------------	------

Four Pole 415V

4086 84	0.5	4	3687	1/32
4086 85	1	4	3687	1/32
4086 87	2	4	3687	1/32
4086 88	3	4	3687	1/32
4086 89	4	4	3687	1/32
4086 91	6	4	3243	1/32
4086 94	10	4	3243	1/32
4086 96	16	4	3243	1/32
4086 97	20	4	3243	1/32
4086 98	25	4	3243	1/32
4086 99	32	4	3243	1/32
4087 00	40	4	4614	1/32
4087 01	50	4	4614	1/32
4087 02	63	4	4614	1/32



4086 94

D Curve

Single Pole 240/415V

4087 06	0.5	1	741	1/10/120
4087 07	1	1	741	1/10/120
4087 09	2	1	741	1/10/120
4087 10	3	1	741	1/10/120
4087 11	4	1	741	1/10/120
4087 12	6	1	616	1/10/120
4087 14	10	1	616	1/10/120
4087 16	16	1	616	1/10/120
4087 17	20	1	616	1/10/120
4087 18	25	1	616	1/10/120
4087 19	32	1	616	1/10/120
4087 20	40	1	■	1/10/120
4087 21	50	1	■	1/10/120
4087 22	63	1	■	1/10/120



4087 19

Single Pole + Neutral 240V

4087 26	0.5	2	1925	1/5/60
4087 27	1	2	1925	1/5/60
4087 29	2	2	1925	1/5/60
4087 30	3	2	1925	1/5/60
4087 31	4	2	1925	1/5/60

Double Pole 415V

4087 32	0.5	2	2017	1/40
4087 33	1	2	2017	1/40
4087 35	2	2	2017	1/40
4087 36	3	2	2017	1/40
4087 37	4	2	2017	1/40
4087 38	6	2	1525	1/40
4087 40	10	2	1525	1/40
4087 42	16	2	1525	1/40
4087 43	20	2	1525	1/40
4087 44	25	2	1525	1/40
4087 45	32	2	1525	1/40
4087 46	40	2	■	1/40
4087 47	50	2	■	1/40
4087 48	63	2	■	1/40



4087 46

D Curve

Cat.Nos	Nominal Rating	Number of 17.5 mm modules	MRP* ₹ / Unit	Pack
---------	----------------	---------------------------	------------------	------

Triple Pole 415V

4087 52	0.5	3	3004	1/32
4087 53	1	3	3004	1/32
4087 55	2	3	3004	1/32
4087 56	3	3	3004	1/32
4087 57	4	3	3004	1/32
4087 58	6	3	2461	1/32
4087 60	10	3	2461	1/32
4087 62	16	3	2461	1/32
4087 63	20	3	2461	1/32
4087 64	25	3	2461	1/32
4087 65	32	3	2461	1/32
4087 66	40	3	■	1/32
4087 67	50	3	■	1/32
4087 68	63	3	■	1/32



4087 52

Triple Pole + Neutral 415V

4087 72	0.5	4	3662	1/32
4087 73	1	4	3662	1/32
4087 75	2	4	3662	1/32
4087 76	3	4	3662	1/32
4087 77	4	4	3662	1/32

Four Pole 415V

4087 78	0.5	4	3652	1/32
4087 79	1	4	3652	1/32
4087 81	2	4	3652	1/32
4087 82	3	4	3652	1/32
4087 83	4	4	3652	1/32
4087 84	6	4	3220	1/32
4087 86	10	4	3220	1/32
4087 88	16	4	3220	1/32
4087 89	20	4	3220	1/32
4087 90	25	4	3220	1/32
4087 91	32	4	3220	1/32
4087 92	40	4	■	1/32
4087 93	50	4	■	1/32
4087 94	63	4	■	1/32



4087 90

Circuit Breakers AC Applications 80 - 125A

10 kA as per IEC 60947-2
Integrated label holder
Sliding insulating shield
Color coded contact indication window
IP 20 protected terminals
50 sq mm terminals

Single Pole 230V / 400V

4085 99	80	1.5	3977	1/5/160
4086 00	100	1.5	4352	1/5/161
4086 01	125	1.5	4722	1/5/162



4086 00

* MRP - Maximum Retail Price Inclusive of all taxes including GST.
■ Price available on request.

Bold Cat.Nos are products normally available with Legrand (India) Stockists. Cat.Nos that are not bold - delivery within 4 - 8 weeks from the date of order. Bold packing quantity is our mandatory packing. Orders to be placed by Legrand (India) Stockist in multiples of the same.

DX³ MCBs



4086 40



4086 63



4087 05

Cat.Nos	Nominal Rating	Number of 17.5 mm modules	MRP* ₹ / Unit	Pack
---------	----------------	---------------------------	---------------	------

Double Pole 230V / 400V*

4086 40	80	3	8814	1/5/60
4086 41	100	3	9393	1/5/60
4086 42	125	3	10228	1/5/60

Triple Pole 400V*

4086 62	80	4.5	14163	1/9
4086 63	100	4.5	15086	1/9
4086 64	125	4.5	16581	1/9

Four Pole 400V*

4087 03	80	6	18264	1/9
4087 04	100	6	19030	1/9
4087 05	125	6	21319	1/9

DX³ DC MCBs

Circuit breakers DC applications upto 63A

6 kA as per IEC 60947-2
 Integrated label holder
 Sliding bottom clamp
 Improved air channels
 Color coded On/Off indication on dolly
 Biconnect lower terminals
 IP 20 protected terminals
 Sliding shutters

Single Pole 250V

4087 98	0.5	1	1095	1/10/120
4087 99	1	1	1095	1/10/120
4088 01	2	1	1095	1/10/120
4088 02	3	1	1095	1/10/120
4088 03	4	1	1095	1/10/120
4088 04	6	1	906	1/10/120
4088 06	10	1	906	1/10/120
4088 08	16	1	906	1/10/120
4088 09	20	1	906	1/10/120
4088 10	25	1	906	1/10/120
4088 11	32	1	915	1/10/120
4088 12	40	1	1210	1/10/120
4088 13	50	1	1210	1/10/120
4088 14	63	1	1210	1/10/120



4088 12

Double Pole 250V

4088 15	0.5	1	2284	1/5/60
4088 16	1	1	2284	1/5/60
4088 18	2	1	2284	1/5/60
4088 19	3	1	2284	1/5/60
4088 20	4	1	2284	1/5/60
4088 21	6	1	2118	1/5/60
4088 23	10	1	2118	1/5/60
4088 25	16	1	2118	1/5/60
4088 26	20	1	2118	1/5/60
4088 27	25	1	2118	1/5/60
4088 28	32	1	2118	1/5/60
4088 29	40	1	2498	1/5/60
4088 30	50	1	2498	1/5/60
4088 31	63	1	2498	1/5/60

* MRP - Maximum Retail Price Inclusive of all taxes including GST.
 ♦ For further details on product contact nearest Legrand Sales Office.

DX³ MCBs

Cat.Nos	Nominal Rating	Number of 17.5 mm modules	MRP* ₹ / Unit	Pack
---------	----------------	---------------------------	---------------	------

DX³ RDSO DC MCB

Single Pole

4088 32	0.5	1	1122	1/10/120
4088 33	1	1	1122	1/10/120
4088 34	1.5	1	1122	1/10/120
4088 35	1.6	1	1122	1/10/120
4088 36	2.5	1	1122	1/10/120
4088 37	3	1	821	1/10/120
4088 38	4	1	821	1/10/120
4088 39	5	1	998	1/10/120
4088 40	10	1	998	1/10/120
4088 41	15	1	998	1/10/120
4088 42	20	1	998	1/10/120
4088 43	25	1	998	1/10/120
4088 44	30	1	1139	1/10/120
4088 45	35	1	1139	1/10/120
4088 46	40	1	1267	1/10/120
4088 47	50	1	1267	1/10/120
4088 48	60	1	1267	1/10/120

DX³ Isolators

Isolators for AC Applications upto 125A

ISI marked as per IEC 60947-3
 Integrated label holder
 Ergonomic red color dolly
 Sliding bottom clamp
 Double break mechanism
 Improved air channels
 Color coded On/Off indication on dolly
 Biconnect lower terminals
 IP 20 protected terminals
 Compatible with signal and control Auxiliaries
 Sliding shutters

Double Pole 240V

4065 00	32	2	780	1/5/60
4065 01	40	2	858	1/5/60
4065 02	63	2	1134	1/5/60
4065 04	100	2	1557	1/5/60
4065 05	125	2	1771	1/5/60



4065 00

Triple Pole 415V

4065 09	32	3	1405	1/40
4065 10	40	3	1507	1/40
4065 11	63	3	1794	1/40
4065 13	100	3	1980	1/40
4065 14	125	3	2284	1/40



4065 10

Four Pole 415V

4065 18	32	4	1541	1/32
4065 19	40	4	1914	1/32
4065 20	63	4	2111	1/32
4065 22	100	4	2551	1/32
4065 23	125	4	2811	1/32



4065 20

Bold Cat.Nos are products normally available with Legrand (India) Stockists. Cat.Nos that are not bold - delivery within 4 - 8 weeks from the date of order. Bold packing quantity is our mandatory packing. Orders to be placed by Legrand (India) Stockist in multiples of the same.

RCD

Advanced Protection for Human Safety and Fire Prevention



DX³ RCDs provide fast, precise earth leakage protection that safeguards people from electric shock and helps prevent fire risks caused by faulty wiring or insulation. They integrate seamlessly within distribution boards, enabling reliable circuit monitoring, advanced control, and remote signalling through modular auxiliary devices.

Features

- Earth leakage protection from 30 mA to 300 mA
- Clip-on auxiliary modules for signalling, shunt release, undervoltage protection, and motorized control
- Integrated test button and robust assembly for reliable fault detection

Benefits

- Simplifies upgrades with tool-free auxiliary installation and modular compatibility
- Improves reliability through precise fault detection



Variants

Type AC

Detects residual alternating currents for standard applications with sinusoidal fault currents

Type A

Detects AC and pulsating DC residual currents for circuits with electronic devices and rectifiers

Type S

Time-delayed tripping for selectivity with downstream RCDs

Type Hpi

High-immunity protection designed to prevent unwanted tripping in disturbed environments (generators, computers, printers)



Scan to know more about the product.

RCCBs for AC Applications Upto 63A

Cat.Nos	Nominal Rating	Number of 17.5 mm modules	MRP* ₹ / Unit	Pack
---------	----------------	---------------------------	---------------	------

DX³ RCCBs

RCCBs for AC Applications Upto 63A

ISI marked as per IS 12640-1
Integrated label holder
Ergonomic Grey color dolly
Sliding bottom clamp
Compatible with signal and control Auxiliaries
Color coded On/Off indication on dolly
Biconnect lower terminals
IP 20 protected terminals
35 sq mm terminals
Sliding shutters

Type - AC

Sensitive to residual alternating currents
Use : standard applications

Double Pole 240V

30 mA

4118 51	25	2	4565	1/5/60
4118 52	40	2	5300	1/5/60
4118 53	63	2	6515	1/5/60

100 mA

4118 56	25	2	5028	1/5/60
4118 57	40	2	5807	1/5/60
4118 58	63	2	6914	1/5/60

300 mA

4118 61	25	2	5114	1/5/60
4118 62	40	2	6100	1/5/60
4118 63	63	2	6942	1/5/60

Four Pole 415V

30 mA

4118 76	25	4	6451	1/32
4118 77	40	4	6613	1/32
4118 78	63	4	7357	1/32

100 mA

4118 81	25	4	6802	1/32
4118 82	40	4	6882	1/32
4118 83	63	4	8094	1/32

300 mA

4118 86	25	4	7006	1/32
4118 87	40	4	7109	1/32
4118 88	63	4	8122	1/32

Type- S

Delayed trip for discrimination with other residual current devices.

Use : for discrimination with a downstream device

Double Pole 415V, A-S

300 mA

4118 66	25	2	9058	1/5/60
4118 67	40	2	9510	1/5/60
4118 68	63	2	9786	1/5/60

Four Pole 415 V, A-S

300 mA

4118 91	25	4	10200	1/5/60
4118 92	40	4	10331	1/5/60
4118 93	63	4	10794	1/5/60



4118 57



4118 77



4118 83



4118 93

* MRP - Maximum Retail Price Inclusive of all taxes including GST.

RCCBs for AC Applications Upto 63A

Cat.Nos	Nominal Rating	Number of 17.5 mm modules	MRP* ₹ / Unit	Pack
---------	----------------	---------------------------	---------------	------

Type HPI

Enhanced immunity to unwanted tripping in environments with disturbances. eg. diesels, computers, printers, etc.

• Detects faults with DC components eg. thyristors, triac etc.

Double Pole 240V HPI

30 mA

4118 71	25	2	9905	1/5/60
4118 72	40	2	10399	1/5/60
4118 73	63	2	10701	1/5/60

Four Pole 415V HPI

30 mA

4118 96	25	4	11220	1/32
4118 97	40	4	11574	1/32
4118 98	63	4	11873	1/32



4118 97

DX³ RCBOs

RCBOs Assembled for AC Applications upto 63A

ISI marked as per IS 12640-2

Integrated label holder
Ergonomic design
Color coded On/Off indication on dolly
Compatible with signal and control Auxiliaries
Front face indication for earth leakage fault
IP 20 protected terminals
35 sq mm terminals
Sliding shutters

Type - AC

Sensitive to residual alternating currents
Use : standard applications

Double Pole 240V AC Type

30 mA

4113 22	6	4	5812	1/32
4113 23	10	4	5812	1/32
4113 24	16	4	5812	1/32
4113 25	25	4	5812	1/32
4113 26	32	4	5812	1/32
4113 27	40	4	6983	1/32
4113 28	63	4	8508	1/32

100 mA

4113 29	6	4	6991	1/32
4113 30	10	4	6991	1/32
4113 31	16	4	6991	1/32
4113 32	25	4	6991	1/32
4113 33	32	4	6991	1/32
4113 34	40	4	7926	1/32
4113 35	63	4	9147	1/32

300 mA

4113 36	16	4	7213	1/32
4113 37	25	4	7213	1/32
4113 38	32	4	7213	1/32
4113 39	40	4	8133	1/32
4113 40	63	4	9163	1/32



4113 24

Bold Cat.Nos are products normally available with Legrand (India) Stockists. Cat.Nos that are not bold - delivery within 4 - 8 weeks from the date of order. Bold packing quantity is our mandatory packing. Orders to be placed by Legrand (India) Stockist in multiples of the same.

RCBOs Assembled for AC Applications Upto 63A

Cat.Nos	Nominal Rating	Number of 17.5 mm modules	MRP* ₹ / Unit	Pack
---------	----------------	---------------------------	---------------	------

Four Pole 415V, AC Type 30 mA

4113 65	16	7	7781	1/16
4113 66	25	7	7781	1/16
4113 67	32	7	7781	1/16
4113 68	40	7	8167	1/16
4113 69	63	7	9368	1/16

Four Pole 415V, AC Type 100 mA

4113 70	16	7	8770	1/16
4113 71	25	7	8770	1/16
4113 72	32	7	8770	1/16
4113 73	40	7	9099	1/16
4113 74	63	7	10013	1/16

Four Pole 415V, AC Type 300 mA

4113 75	16	7	9122	1/16
4113 76	25	7	9122	1/16
4113 77	32	7	9112	1/16
4113 78	40	7	9547	1/16
4113 79	63	7	10189	1/16



4113 79

RCBOs Compact for AC Applications

upto 32A, 6kA

Conforms to IEC 60947

Integrated label holder

Ergonomic design

Color coded On/Off indication on dolly

Front face indication for earth leakage fault

IP 20 protected terminals

35 sq mm terminals

Sliding shutters

Type- AC

Sensitive to residual alternating currents

Use : standard applications

Double Pole 240V, AC Type

30 mA

4113 90	6	2	6909	1/32
4113 91	10	2	6909	1/32
4113 92	16	2	6909	1/32
4113 93	20	2	6909	1/32
4113 94	25	2	6909	1/32
4113 95	32	2	6909	1/32



4113 94

300 mA

4113 97	6	2	7243	1/32
4113 98	10	2	7243	1/32
4113 99	16	2	7243	1/32
4114 00	20	2	7243	1/32
4114 01	25	2	7243	1/32
4114 02	32	2	7243	1/32

* MRP - Maximum Retail Price Inclusive of all taxes including GST.

RCBOs Compact for AC Applications

Cat.Nos	Description	Number of 17.5 mm modules	MRP* ₹ / Unit	Pack
---------	-------------	---------------------------	---------------	------

Four Pole 415V, AC Type 30 mA

4114 18	10	4	9440	1/16
4114 19	16	4	9440	1/16
4114 20	20	4	9440	1/16
4114 21	25	4	9440	1/16

Four Pole 415V, AC Type 300 mA

4114 23	10	4	10846	1/16
4114 24	16	4	10846	1/16
4114 25	20	4	10846	1/16
4114 26	25	4	10846	1/16

Type HPI

Enhanced immunity to unwanted tripping in environments with disturbances. eg. diesels, computers, printers, etc.

• Detects faults with DC components eg. thyristors, trio etc.

Double Pole 240V, HPI Type

30 mA

4114 15	25	2	13395	1/32
4114 16	32	2	13395	1/32

Type A

Sensitive to residual alternating currents and residual currents with a DC component.

Use : special applications

- if it is possible that the fault currents are not purely sinusoidal (rectifier bridge, etc.)

Four Pole 415V, A Type

30 mA

4114 28	10	4	10646	1/16
4114 29	16	4	10646	1/16
4114 30	20	4	10646	1/16
4114 31	25	4	10646	1/16

Four Pole 415V, A Type

300 mA

4114 33	10	4	12001	1/16
4114 34	16	4	12001	1/16
4114 35	20	4	12001	1/16
4114 36	25	4	12001	1/16

DX³ RCD Add on Module

For 125A

Conform to IEC 61009-1

AC type : detect AC components faults

Hpi type : detect faults with AC and DC components, increased

Immunity to false tripping

For mounting on the right-hand side of 1.5 module per pole DX³ MCBs

Easy & fast association mechanism

Terminal cover for locking

70 sq mm terminals

Bold Cat.Nos are products normally available with Legrand (India) Stockists. Cat.Nos that are not bold - delivery within 4 - 8 weeks from the date of order. Bold packing quantity is our mandatory packing. Orders to be placed by Legrand (India) Stockist in multiples of the same.

DX³ RCD Add on Module

Cat.Nos	Nominal Rating	Number of 17.5 mm modules	MRP* ₹ / Unit	Pack
---------	----------------	---------------------------	---------------	------

Double pole 240V, AC type

30 mA

4105 68	125 A	4	20780	1
---------	-------	---	-------	---

100 mA

4105 69	125 A	4	23433	1
---------	-------	---	-------	---

300 mA

4105 71	125 A	4	23433	1
---------	-------	---	-------	---

Four Pole 415V, AC Type

30 mA

4106 25	125 A	4	30967	1
---------	-------	---	-------	---

100 mA

4106 26	125 A	4	34604	1
---------	-------	---	-------	---

300 mA

4106 29	125 A	4	34604	1
---------	-------	---	-------	---

Double Pole 240V, HPI Type

30 mA

4105 78	125 A	6	25957	1
---------	-------	---	-------	---

100 mA

4105 79	125 A	6	29014	1
---------	-------	---	-------	---

300 mA

4105 82	125 A	6	29014	1
---------	-------	---	-------	---

Four Pole 415V, HPI Type

30 mA

4106 38	125 A	6	42911	1
---------	-------	---	-------	---

100 mA

4106 39	125 A	6	45306	1
---------	-------	---	-------	---

300 mA

4106 42	125 A	6	45306	1
---------	-------	---	-------	---

DX³ Auxiliaries

Auxiliaries Common for MCBs, Isolators, RCCBs & RCBOs

Easy & fast fixation on site

On site clip on mounting

Clip on fitting on left side

Signalling Auxiliaries

4062 50	Auxiliary changeover switch 6 A	0.5	1490	1
4062 52	Fault signalling changeover switch 6 A	0.5	1737	1
4062 64	Changeover + fault signalling switch	1	2751	1



4105 68



4105 78



4062 50



4062 52

DX³ Auxiliaries

Cat.Nos	Description	Number of 17.5 mm modules	MRP* ₹ / Unit	Pack
---------	-------------	---------------------------	---------------	------

Control Auxiliaries

4062 76	Shunt release 12 /48 V AC/ DC	1	3827	1
4062 78	Shunt release 110/415 V V AC	1	3827	1
4062 80	Undervoltage release 24/48 V AC/DC	1	3259	1
4062 82	Undervoltage release 230 V AC	1	3259	1



4062 78



4062 82

Control Auxiliaries

4062 86	POP over voltage release	1	4154	1
4062 90	Motor control 24/48 V AC/ DC	1	14975	1
4062 91	Motor control 110/415 V AC	1	14975	1
4062 93	Motor control 24/48 V AC/ DC	2	28193	1
4062 95	Motor control 110/415 V AC	2	26629	1
4062 88	Automatic resetter	2	19886	1
4062 89	Automatic resetter with autotest	2	24888	1

Rotary Handle

4063 19	Black rotary handle	-	3110	10
4063 20	Yellow/red rotary handle	-	3365	10

Support for Padlock

4063 03	Support for padlock till 63 A	-	720	10
---------	-------------------------------	---	-----	----

Sealable Screw Cover

4063 04	Devices upto 63 A	-	713	10
4063 06	For 80-125 A devices	-	1244	10

1/2 Module Spacing Unit

4063 07	1/2 module spacing unit	0.5	262	10
---------	-------------------------	-----	-----	----

5 mm Padlock

4063 13	5 mm Padlock	0.5	610	10
---------	--------------	-----	-----	----

* MRP - Maximum Retail Price Inclusive of all taxes including GST.

Bold Cat.Nos are products normally available with Legrand (India) Stockists. Cat.Nos that are not bold - delivery within 4 - 8 weeks from the date of order. Bold packing quantity is our mandatory packing. Orders to be placed by Legrand (India) Stockist in multiples of the same.

DX³ Auxiliaries

Cat.Nos	Description	Number of 17.5 mm modules	MRP* ₹ / Unit	Pack
---------	-------------	---------------------------	---------------	------

Manual Changerover Switch

Compact design
Manual switching operation
Easy to assemble
Ergonomic design

For 1 Mod/Pole Devices

4063 14	Manual change-over switch for DP	1	3531	5
4063 15	Manual change-over switch for TP	1	4078	5
4063 16	Manual change-over switch for FP	1	4531	5

DX³ RCD add on Module

With Measurement & Metering

Cat.Nos	Nominal Rating	Number of 17.5 mm modules	MRP* ₹ / Unit	Pack
---------	----------------	---------------------------	---------------	------

Conform to IEC 61009-1
Hpi type: detect faults with AC and DC components, increased
Immunity to false tripping
Inbuilt measurement/metering option
Measurement - V, A, F, PF, KWh, KVA, KVAr, THD
Metering - V, A, F, KWh
RS 485 port for remote reading
Di-electric test button inbuilt
Ergonomic test button
Scroll button for easy readings
RLCD display on front facia
For mounting on the right-hand side of 1.5 module per pole DX3 MCBs
Easy & fast association mechanism
70 sq mm terminals

Adjustable Metering, Four Pole 415 V

4106 57	63 A	7	22772	1
4106 58	125 A	7	40861	1

Adjustable Measurement

4106 59	125 A	7	44518	1
---------	-------	---	-------	---

DX³ Time Switches

Cat.Nos	Description	No. of Modules	MRP* ₹ / Unit	Pack
---------	-------------	----------------	---------------	------

For Switching an Electric Circuit (Lighting, Heating) on Or Off at Selected Times During a Pre-Programmed Time Period.

Alpharex3 Digital Time Swiches Weekly Time Switch

Time-saving programming by selection of daily blocks, daily blocks individually adjustable or selection from preset blocks Mo-Fr and Mo-Su
Permanent ON or OFF
Circuit anticipation
Power reserve 3 years for date, time and switching program
Accuracy +/- 1 sec./Day

* MRP - Maximum Retail Price Inclusive of all taxes including GST.

DX³ Time Switches

Cat.Nos	Description	No. of Modules	MRP* ₹ / Unit	Pack
---------	-------------	----------------	---------------	------

0037 10	Power supply 230 V \sim 50/60Hz 1 NO contact 250 V/50 Hz 16 A - cos ϕ = 1 28 programmes Shortest switching-time 1 min	1	7514	1
---------	--	---	------	---

Multiple Functions - Daily or Weekly Time Switch Programme - 5 Years Clock Working Reserve

Programme settings: on daily or weekly basis
15 languages
A programme consists of a on and off time and their assignement to certain days
Option to suspend the programme for a specific period to set-up with start and date
Minimum programme setting: 1 s.
High precision clock: \pm 0.1 sec per day
Particularly suited to irregular cycles:
- security installations (access point, alarms, etc.),
- industrial installations (pump stations, etc.)
Programmed directly on keypad, or using program transfer key Cat.No 4 128 72
Additional functions including random (irregular cycles), hour counters

4126 31	1 output 16 A - 250 V \sim 50/60 Hz 56 programmes 1 Channel	2	8765	1
4126 41	2 output 16 A - 250 V \sim 50/60Hz 2x28 programmes 2 Channel	2	12451	1



4126 41

Digital Time Switch with Astronomical Function

- For switching on/off lights and other electric devices according to the rising/setting of the sun
- With combination function for creating switching programs in which the devices are switched according to astronomical time and/or fixed preset times
- Daily astronomical calculation of the sunrise/sunset times based on the entered location or location coordinates

4126 54	1 output 16 A - 250 V \sim 50/60 Hz Astronomical function 56 Programmes 1 Channel	2	15512	1
4126 57	2 output 16 A - 250 V \sim 50/60 Hz Astronomical function 2x28 programmes 2 Channel	2	17702	1



4126 54



4126 57

Alpharex³ Yearly Time Switch

- Yearly and weekly time switch with additional astronomical function for all channels
- 84 switching programs per channel, comprising:
 - 28 weekly programs
 - 28 yearly programs
 - 28 special programs (priority program)

4126 30	2 outputs - 230 V \sim 50/60 Hz Astronomical function 2 x 3 x 28 = 168 programmes	2	29037	1
---------	---	---	-------	---

Bold Cat.Nos are products normally available with Legrand (India) Stockists. Cat.Nos that are not bold - delivery within 4 - 8 weeks from the date of order. Bold packing quantity is our mandatory packing. Orders to be placed by Legrand (India) Stockist in multiples of the same.



4106 57

Dx³ Time Switches

Cat.Nos	Description	MRP* ₹ / Unit	Pack
Programming Accessories			
4128 72	Programming transfer key Can be used to store programme settings made: Directly on a multifunction and multi-programme time switch Cat.Nos 4 126 30/31/32/33/41/54/57 (loading on device) -with the programming software installed on a PC running Windows (loading on data loader)	3262	1
4128 73	Programming software Kit Can be used to create, save and transfer program settings for multifunction and multi-program time switches. Data is transferred to the program transfer key using the data loader connected to the USB port of the PC. 4128 73 Kit comprising software on CD-ROM, data loader and transfer key Windows XP, Windows 7, Windows 8 compatible"	6960	1

Twilight Switches

- Light sensitive switches
- Can be used to switch a lighting circuit "ON" and "OFF" based on light conditions (nightfall, daybreak)
- Supplied with IP 65 weatherproof photoelectric cell
- Adjustable from 1 to 100 000 lux

4126 23	Luxo Switch / Light sensitive switch with Lux Sensor - Output 16 A 250 V~	11092	1
---------	---	-------	---

MicroRex Analog Time Switches

Programmed via captive segment
Power supply: 230 V~ 50/60 Hz
3-position override switch "ON-AUTO-OFF" on front panel

Manual changeover to summer/winter time
1 outlet 16 A - 250 V~ - $\mu \cos = 1$

Analog Time Switch Daily Programme

1 segment = 15 minutes

Accuracy: ± 5 minutes

1 outlet 16 A - 250 V~ - $\mu \cos = 1$

4127 80	Vertical Dial N/O Contact - without working Reserve -Minimum switching time: 15 minutes	1	4571	1
4127 90	Vertical Dial N/O Contact - with 100 h working Reserve -Minimum switching time: 15 minutes	1	5383	1

* MRP - Maximum Retail Price Inclusive of all taxes including GST.



4128 12

Power Contactors / Modular Contactors CX³

Cat.Nos	Description	MRP* ₹ / Unit	Pack	
4128 12	Horizontal Dial Changeover Switch - without working Reserve -Minimum switching time: 15 minutes	3	6768	1
4128 13	Horizontal Dial Changeover Switch - with 100 h working Reserve -Minimum switching time: 15 minutes	3	8383	1

Analog Time Switch Weekly Programme

1 segment = 2 hours

Accuracy: ± 30 minutes

1 outlet 16 A - 250 V~ - $\mu \cos = 1$

4127 94	Vertical Dial N/O Contact - with 100 h working Reserve -Minimum switching time: 2 hours	1	5848	1
4127 95	Horizontal Dial Changeover Switch - with 100 h working Reserve -Minimum switching time: 4 hours	3	8470	1

DX³ Contactors

Power Contactors / Modular Contactors CX³

Conform to IEC/EN 61095

Space for power supply busbar on top (up to 25 A)

Power contactors with 230 V~ coil and handle

Manual override for test and repair function, carried out via the handle

Permanent "ON" or "OFF" without automatic closing of the contactor

4125 44	25 A 2 NO contactor	3260	1
4125 45	40 A 2 NO contactor	5560	1
4125 47	63 A 2 NO contactor	6470	1
4125 48	63 A 2 NC contactor	6470	1
4125 49	40 A 3 NO contactor	9300	1
4125 50	63 A 3 NO contactor	10500	1
4125 51	25 A 4 NO contactor	3840	1
4125 53	40 A 4 NO contactor	9810	1
4125 56	63 A 4 NO contactor	11610	1
4125 57	63 A 4 NC contactor	11720	1

Signalling Auxiliaries for Contactors

Auxiliary changeover switch

4124 29	For 1 module contactors 16 A to 25 A	4770	1
4124 30	For 2 module contactors 25 A	4790	1
4124 31	For 2 module contactors 25 A	6280	1

Bold Cat.Nos are products normally available with Legrand (India) Stockists. Cat.Nos that are not bold - delivery within 4 - 8 weeks from the date of order. Bold packing quantity is our mandatory packing. Orders to be placed by Legrand (India) Stockist in multiples of the same.

DX³ for Photovoltaic Applications

Cat.Nos	Description	MRP* ₹ / Unit	Pack
---------	-------------	---------------------	------

DC MCBs

Breaking capacity 4.5 kA according to EN 60947-2

800 V= Circuit Breakers

4144 24	6 A	9232	1
4144 25	8 A	9232	1
4144 26	10 A	9232	1
4144 27	13 A	9232	1
4144 28	16 A	9232	1
4144 29	20 A	9232	1

1000 V= Circuit Breakers

4144 46	10 A	24738	1
4144 47	13 A	24738	1
4144 48	16 A	24738	1
4144 49	20 A	24738	1

DC Rotary Handle Isolating Switches

Category of use DC 21B according to EN 60947-3

Double break contacts

600 V= isolating switches

4142 61	16 A	10408	1
4142 62	25 A	11756	1
4142 63	32 A	11756	1

* MRP - Maximum Retail Price Inclusive of all taxes including GST.

Cat.Nos	Description	MRP* ₹ / Unit	Pack
---------	-------------	---------------------	------

1000 V= Isolating Switches

4142 81	16 A	20154	1
4142 82	25 A	20110	1
4142 83	32 A	20902	1

Accessories

4063 05	Pole separation divider	196	1
4063 07	Spacing unit 0.5 unit	262	10

Bold Cat.Nos are products normally available with Legrand (India) Stockists. Cat.Nos that are not bold - delivery within 4 - 8 weeks from the date of order. Bold packing quantity is our mandatory packing. Orders to be placed by Legrand (India) Stockist in multiples of the same.

Surge Protective Devices (SPDs)

Reliable Protection Against Lightning & Power Surges



Surge Protective Devices protect electrical installations from lightning-induced overvoltages and power surges. Designed for residential, commercial, industrial, and photovoltaic systems, they safely divert surge energy to earth to help maintain reliable and continuous power distribution.

Features

- Type 1 and T1+T2 SPDs with impulse current capacity from 12.5 kA to 100 kA
- Type 2 SPDs with surge capacity from 20 kA to 45 kA
- PV and DC SPDs supporting photovoltaic systems up to 1500 V
- Plug-in modular design with status indicators for quick replacement and easy maintenance

Benefits

- Prevents damage to costly electrical & electronic equipment
- Improves system reliability by reducing downtime and power interruptions
- Enables faster installation and maintenance with modular design
- Supports a wide range of electrical and solar power installations



T1 SPDs

are designed to provide protection in the main distribution board.

T1+T2 SPDs

are increasingly used at the supply end of installations and comply with the specifications of both T1 and T2 SPDs.

T2 SPDs

typically provide protection in secondary distribution boards or consumer units.

Scan to know more about the product.



Low Voltage SPDs

Cat.Nos	Number of poles	Neutral position	I total (10/350)	Remote status monitoring (logging contact)	Number of modules	MRP* ₹ / Unit
---------	-----------------	------------------	------------------	--	-------------------	---------------

SPDs for General Protection of Main Distribution Board

T1+T2 - limp 12,5 kA/pole T2 - 60 kA

4122 70	1P	-	12.5 kA	No	1	10582
4122 76 ¹	1P+N	Right	25 kA	Yes	2	18619
4122 71	2P	-	25 kA	No	2	20433
4122 72	3P	-	37.5 kA	Yes	3	25332
4122 77 ¹	3P+N	Right	50 kA	Yes	4	33944
4122 73	4P	-	50 kA	No	4	35000

T1+T2 - limp 8 kA/pole T2 - 60 kA

4122 50	1P	-	8 kA	No	1	■
4122 56 ¹	1P+N	Right	16 kA	No	2	■
4122 51	2P	-	16 kA	No	2	■
4122 52	3P	-	25 kA	No	3	■
4122 57 ¹	3P+N	Right	25 kA	No	4	■
4122 53	4P	-	32 kA	No	4	■

SPDs for High Risk Level Installations

T1 - limp 35 kA/pole - 440 V± (IT) - Plug-in

4122 80	1P	-	35 kA	Yes	2	23419
---------	----	---	-------	-----	---	-------

T1 - limp 25 kA/pole

4122 81 ¹	1P+N	Right	50 kA	Yes	4	30429
4122 82	3P	-	75 kA	Yes	6	72748
4122 83 ¹	3P+N	Right	100 kA	Yes	8	83500

Replacement Plug-In Modules

Cat.Nos	Description	MRP* ₹ / Unit	Pack
---------	-------------	---------------	------

4123 02	For SPDs T1+T2 - 8 kA Cat.Nos 4122 50/ 51/52/53/56/57	8314	1
4123 03	For SPDs T1+T2 - 12.5 kA Cat.Nos 4122 70/ 71/72/73/76/77	7844	1
4122 84	For SPDs T1 - 25 kA Cat.Nos 4122 81/82/83 and 0030 20/22/23/27	22791	1
4122 85	N-PE module for SPDs T1 - 25 kA Cat.Nos 4122 81/83 and 0030 23	30931	1
4122 86	For SPDs T1 - 35 kA Cat.No 4122 80	7644	1

Bold Cat.Nos are products normally available with Legrand (India) Stockists. Cat.Nos that are not bold - delivery within 4 - 8 weeks from the date of order. Bold packing quantity is our mandatory packing. Orders to be placed by Legrand (India) Stockist in multiples of the same.

Low Voltage SPDs

Cat.Nos	Description	MRP* ₹ / Unit	Pack
---------	-------------	---------------	------

Cabling Accessories

4123 10	Ready to use cabling kit consisting of 5 conductors (including the earth conductor) Cross section :16 mm ² Lenght : 40 cm For cabling SPDs in industrial enclosures (for EN/IEC 61439 compliance).	1636	1
---------	--	------	---

T2 SPDs

T2 - I_{max} 40 kA/pole

4122 40	1P	-	No	1	■	1
4122 46 ¹	1P+N	Right	No	2	■	1
4122 41	2P	-	No	2	■	1
4122 42	3P	-	Yes	3	■	1
4122 47 ¹	3P+N	Right	No	4	■	1
4122 43	4P	-	No	4	■	1

T2 - I_{max} 40 kA/pole - 440 V~ (IT)

4122 30	1P	-	No	1	■	1
4122 32	3P	-	Yes	3	■	1
4122 33	4P	-	Yes	4	■	1

T2 - I_{max} 20 kA/pole

4122 20	1P	-	No	1	■	1
4122 26 ¹	1P+N	Right	No	2	■	1
4122 21	2P	-	No	2	■	1
4122 27 ¹	3P+N	Right	No	4	■	1
4122 23	4P	-	No	4	■	1

Replacement Plug-In Modules

4122 99	For SPDs T2 - 40 kA Cat.Nos 4122 40/ 41/42/43/44/45/ 46/47/66/67	5401	1
4123 00	N-PE module for SPDs T2 - 40 kA Cat.Nos 4122 46/47	10813	1
4123 01	For SPDs T2 - 440 V Cat.Nos 4122 30/32/33	■	1
4122 97	For SPDs T2 - 20 kA Cat.Nos 4122 20/ 21/23/26/27/62/63	■	1

* MRP - Maximum Retail Price Inclusive of all taxes including GST.
■ Price available on request.



4122 57



4122 43



4122 83



4123 03



4122 84



4122 99

Low voltage SPDs

Without Short-Circuit Protection

Cat.Nos	Description	MRP* ₹ / Unit
---------	-------------	---------------------

T1+T2 - limp 12.5 kA - Uc 385 VA

Up 1.9 kV, Uc 385 VA

Type 1 characteristics: limp 12.5 kA

Type 2 characteristics: In 30 kA and I_{max} 60 kA

Neutral earthing systems: TT, TN

Protection against short-circuited end of life to be added: gG/gL fuse: 125 A

4103 70	Spd T1+T2/12.5kA 1P 385V	4860
4103 74	Spd T1+T2/12.5kA 1P+N 385V	7020
4143 74	Spdt1+T2/12.5kA1P+N 385v With Status Feedback	8100
4103 71	Spd T1+T2/12.5kA 2P 385V	9720
4103 72	Spd T1+T2/12.5kA 3P 385V	14580
4103 75	Spd T1+T2/12.5kA 3p+N 385V	16740
4143 75	SPD T1+T2/12.5kA 3P+N3 85V with Status Feedback	17820
4103 73	Spd T1+T2/12.5kA 4P 385V	19440



4103 73

Protection for N-PE Application

T1+T2 - limp 25 kA - Uc 260 VA for 1P+N Installations

Up 1.4 kV, Uc 260 VA

Type 1 characteristics: limp 25 kA

Type 2 characteristics: In 30 kA and I_{max} 60 kA

Neutral earthing systems: TT, TN

To be used in combination with one 1P varistor SPD

T1+T2 limp 12.5 kA Uc 175 VA or 385 VA

Cat. Nos 4 103 70 and 4 143 06 to protect the neutral branch

4103 10	1P GDT N-EAR SPD T1+T2/12.5kA	7020
---------	-------------------------------	------

T1+T2 - limp 50 kA - Uc 260 VA for 3P+N Installations

Up 1.5 kV, Uc 260 VA

Type 1 characteristics: limp 50 kA

Type 2 characteristics: In 30 kA and I_{max} 60 kA

Neutral earthing systems: TT, TN

To be used in combination with three 1P varistor SPDs

T1+T2 limp 12.5 kA Uc 175 VA or 385 VA

Cat. Nos 4 103 70 and 4 143 06 to protect the neutral branch

4103 12	1P GDT N-EAR SPD T1+T2/12.5kA	7020
---------	-------------------------------	------

* MRP - Maximum Retail Price Inclusive of all taxes including GST.

1 1P+N and 3P+N: L-N and N-PE protection modes (common and differential modes), the N pole being protected by encapsulated spark gaps. Also called sometimes 1+1 and 3+1

Low voltage SPDs

Without Short-Circuit Protection

Cat.Nos	Description	MRP* ₹ / Unit
---------	-------------	---------------------

Plug-in Replacement Modules

4122 86	For T1+T2/35 kA SPDs	7644
4122 84	For T1+T2/25 kA SPDs	22791
4122 85	For T1+T2/25 kA SPDs (N-PE module)	30931
4103 01	Plugin Mod SPDT1+T2/12.5KA385V	3780
4103 11	Plugin Mod for 410310	5940
4103 13	Plug-In Module for 410310	5940



4122 84



4103 01



4103 13

T1+T2 - T2 - I_{max} 45 kA - Uc 460 VA

Up 2.5 kV, Uc 460 VA

Type 2 characteristic: In 10 kA, I_{max} 20 kA

Neutral earthing systems: TT, TN, IT (PN < 120 V)

Protection against short-circuited end of life to be added: gG/gL fuse: 80 A

4143 60	SPD T2/45 kA1P 460V with Status Feedback	3780
4143 61	SPD T2/45 kA 2P 460V with Status Feedback	7020
4143 62	SPD T2/45 kA 3P 460V with Status Feedback	9990
4143 63	SPD T2/45 kA 4P 460V with Status Feedback	12960

T2 - I_{max} 45 kA - Uc 320 VA

Up 1.8 kV, Uc 320 VA

Type 2 characteristic: In 20 kA, I_{max} 45 kA

Neutral earthing systems: TT, TN

Protection against short-circuited end of life to be added: gG/gL fuse: 80 A

4103 40	SPD T2/45 kA 1P 320V	2970
4103 44	SPD T2/45 kA 1P+N 320V	4050
4143 44	SPD T2/45 kA 1P+N 320V with Status Feedback	5130
4103 41	SPD T2/45 kA 2P 320V	5940
4103 42	SPD T2/45 kA 3P 320V	8910
4103 45	SPD T2/45 kA 3P+N 320V	9990
4143 45	SPD T2/45 kA 3P+N 320V with Status Feedback	11070
4103 43	SPD T2/45 kA 4P 320V	11880



4103 45

Bold Cat.Nos are products normally available with Legrand (India) Stockists. Cat.Nos that are not bold - delivery within 4 - 8 weeks from the date of order. Bold packing quantity is our mandatory packing. Orders to be placed by Legrand (India) Stockist in multiples of the same.

Type 2 (T2) SPDs

Without Short-Circuit Protection

Cat.Nos	Description	MRP* ₹ / Unit	Pack
---------	-------------	------------------	------

T2 - I_{max} 20 kA - Uc 460 VA

Up 2 kV, Uc 460 VA

Type 2 characteristic: In 20 kA, I_{max} 45 kA

Neutral earthing systems: TT, TN, IT (PN < 120 V)

Protection against short-circuited end of life to be added: gG/gL fuse: 80 A

4143 50	SPD T2/20 kA 1P 460V with Status Feedback	3618	
4143 51	SPD T2/20 kA 2P 460V with Status Feedback	6156	
4143 52	SPD T2/20 kA 3P 460V with Status Feedback	8694	
4143 53	SPD T2/20 kA 4P 460V with Status Feedback	10152	

SPDs Without Short-Circuit Protection

T2 - I_{max} 20 kA - Uc 320 VA

Up 1.2 kV, Uc 320 VA

Type 2 characteristic: In 10 kA, I_{max} 20 kA

Neutral earthing systems: TT, TN

Protection against short-circuited end of life to be added: gG/gL fuse: 80 A

4103 20	SPD T2/20 kA 1P 320V	2538	
4103 24	SPD T2/20 kA 1P+N 320V	3618	
4143 24	SPD T2/20 kA 1P+N 320V with Status Feedback	4698	
4103 21	SPD T2/20 kA 2P 320V	5076	
4103 22	SPD T2/20 kA 3P 320V	7614	
4103 25	SPD T2/20 kA 3P+N 320V	8694	
4143 25	SPD T2/20 kA 3P+N 320V with Status Feedback	9774	
4103 23	SPD T2/20 kA 4P 320V	10152	

Plug-In Replacement Modules

4103 05	Plugin Mod for SPD T2/45 kA 460V	2700	
4103 04	Plugin Mod for SPD T2/45 kA 320V	2700	
4103 03	Plugin Module SPD T2/20 kA 460V	2160	
4103 02	Plugin Module SPD T2/20 kA 320V	2160	
4103 15	Plugin Mod for 410314	2700	
4103 17	Plug-In Module for 410316	2970	



4103 20



4103 24



4103 23



4103 02

Type 2 (T2) SPDs

Without Short-Circuit Protection

Cat.Nos	Description	MRP* ₹ / Unit	Pack
---------	-------------	------------------	------

Spark Gap SPDs Without Short-Circuit Protection for N-PE Applications

T2 - I_{max} 20 kA - Uc 260 VA for 1P+N Installations

Up 2 kV, Uc 260 VA

Type 2 characteristic: In 20 kA, I_{max} 45 kA

Neutral earthing systems: TT, TN

To be used in combination with one or three 1P varistor

SPD T2 I_{max} 20 kA Uc 175 VA or 385 VA

Cat. Nos 4 103 20/80 to protect the neutral branch

4103 14	1P GDT N-Earth SPD T2/20 kA 260V	2700	
---------	----------------------------------	------	--

T2 - I_{max} 45 kA - Uc 260 VA for 1P+N Installations

Up 2 kV, Uc 260 VA

Type 1 characteristics: I_{imp} 50 kA

Type 2 characteristics: In 30 kA and I_{max} 60 kA

Neutral earthing systems: TT, TN

To be used in combination with one or three 1P varistor

SPD T2 I_{max} 45 kA Uc 175 VA or 385 VA

Cat. Nos 4 103 40/90 to protect the neutral branch

4103 16	1P GDT N-EAR SPD T2/45 kA 260V	3240	
---------	--------------------------------	------	--



4103 16



4103 15

Plug-In Replacement Modules

4103 15	Plugin Mod for 410314	2700	
4103 17	Plug-In Module for 410316	2970	

SPDs Without Short-Circuit Protection

T2 - I_{max} 40 kA - Uc 1500 V_{DC}

Up 5 kV, Uc 1500 V_{DC}

Type 2 characteristic: In 18 kA, I_{max} 40 kA

4103 58	SPD for PV T2/40 kA 1500V DC	9720	
---------	------------------------------	------	--

T2 - I_{max} 40 kA - Uc 1040 V_{DC}

Up 3.5 kV, Uc 1040 V_{DC}

Type 2 characteristic: In 18 kA, I_{max} 40 kA

4103 57	SPD for PV T2/40 kA 1040V DC	8640	
---------	------------------------------	------	--



4103 57

Plug-In Replacement Modules

4103 98	Plugin Mod PV SPD T2/40 kA 1500V DC	4320	
4103 97	Plugin Mod PV SPD T2/40 kA 1040V DC	3780	



4103 97

ACCL

Automatic Changeover with Current Limiter

Seamless Power Switching for Smart Electrical Systems



ACCL ensures uninterrupted power by automatically switching between mains and generator supply. Designed with intelligent control and built-in current limiting, it protects the generator from overload while maintaining reliable power continuity for residential and commercial installations.

Features

- Intelligent microcontroller-based design
- Built-in current limiter to prevent generator overload
- Break-before-make switching mechanism with neutral isolation
- LED status indicators with buzzer alerts and manual reset function

Benefits

- Ensures continuous power supply during mains failure
- Protects generator systems from overload damage
- Improves safety through controlled and reliable power transfer
- Simplifies monitoring with clear visual and audible status alerts

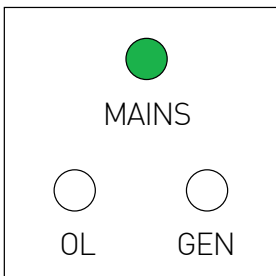

Mains ON

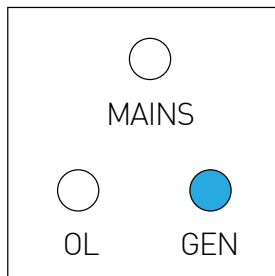

Genset ON

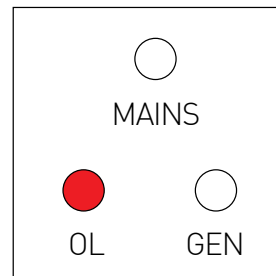

Overload



Scan to know more about the product.

DX³ Changeover Switches

Cat.Nos	Description	MRP* ₹ / Unit	Pack
---------	-------------	------------------	------

Changeover Switches

Single Pole - Two Way - 250V AC

4129 00	32 A	4791	10/100
---------	------	------	--------

Double Pole - Two Way - 400V AC

4129 01	32 A	4791	5/50
---------	------	------	------

Double Pole - Two Way with Centre Off - 400V AC

4129 03	32 A	5016	5/50
---------	------	------	------

Four Pole - Two Way with Centre Off - 400V AC

6040 22	40 A	7769	2/20
---------	------	------	------

Automatic Changeover with Current Limiter(ACCL)

Intelligent micro controller based design

Automatic source change over between Mains & Generator supply

Break before make change over system

Buzzer and Led Indication of status

Current limitation prevents overloading of the generator

4053 00	SPN 30/3A	3220	1/15
4053 01	SPN 30/4A	3220	1/15
4053 02	SPN 30/5A	3220	1/15
4053 03	SPN 30/6A	3220	1/15
4053 04	SPN 30/9A	3220	1/15
4053 05	SPN 30/12A	3220	1/15
4053 06	SPN 30/15A	3220	1/15
4053 07	SPN 30/20A	3220	1/15
4053 08	SPN 30/30A	3220	1/15

DX³ Push Button Push Button Cum Switch - 1 Module - 20A-250V AC

Single Function

4129 08	Contact 1 NO	3958	10/100
4129 09	Contact 1 NC	3958	10/60
4129 10	Contact 2 NO	3958	10/60

* MRP - Maximum Retail Price Inclusive of all taxes including GST.

DX³ Indicators

Cat.Nos	Description	MRP* ₹ / Unit	Pack
---------	-------------	------------------	------

Dual Function

4129 14	Contact - 1 NO + green indicator	3958	10/60
4129 15	Contact - 1 NC + red indicator	3958	10/60

Single Indicators - 1 Module - 250 V AC

Possible to replace E10 lamps and diffusers. E10 - 1.2 Watt, 230 V AC

4129 26	Colour - Green	1152	10/100
4129 27	Colour - Red	1152	10/100
4129 28	Colour - Orange	1152	10/100
4129 29	Colour - Blue	1152	10/100
4129 32	White + White + White	2102	10/100
4129 33	Red + Red + Red	2102	10/100
4129 34	Red + Yellow + Green	2102	10/100
4129 35	Red + Yellow + Blue	2141	10/100

MaxiRex

6499 15	MaxiRex 4QT (daily)	9100	1/30
---------	---------------------	------	------

EconoRex

0499 86	EconoRex MQT (24hrs.)	8803	1/30
---------	-----------------------	------	------

Current Transformers

- Used with ammeters, electricity meters
- Supply a current of 5 A to the secondary which is proportional to the primary current.
- Fix to plate or rail EN 60715

4121 01	50/5 Precision in % - 1 Power in VA - 1.5	3852	1/12
4121 03	100/5 Precision in % - 1 Power in VA - 1.5	5240	1/12
4121 06	200/5 Precision in % - 0.5 Power in VA - 4	5240	1/12
4121 24	200/5 Precision in % - 0.5 Power in VA - 5	4960	1/12
4121 25	400/5 Precision in % - 0.5 Power in VA - 8	5140	1/12
4121 36	600/5 Precision in % - 0.5 Power in VA - 12	5220	1/12
4121 38	800/5 Precision in % - 0.5 Power in VA - 8	7640	1/12
4121 39	1000/5 Precision in % - 0.5 Power in VA - 10	8080	1/12
4121 42	1250/5 Precision in % - 0.5 Power in VA - 12	9420	1/12

Bold Cat.Nos are products normally available with Legrand (India) Stockists. Cat.Nos that are not bold - delivery within 4 - 8 weeks from the date of order. Bold packing quantity is our mandatory packing. Orders to be placed by Legrand (India) Stockist in multiples of the same.

Ekinox

Reinvent The New

Safety Styled for
Modern Spaces



MAKE A **SECOND** GLANCE

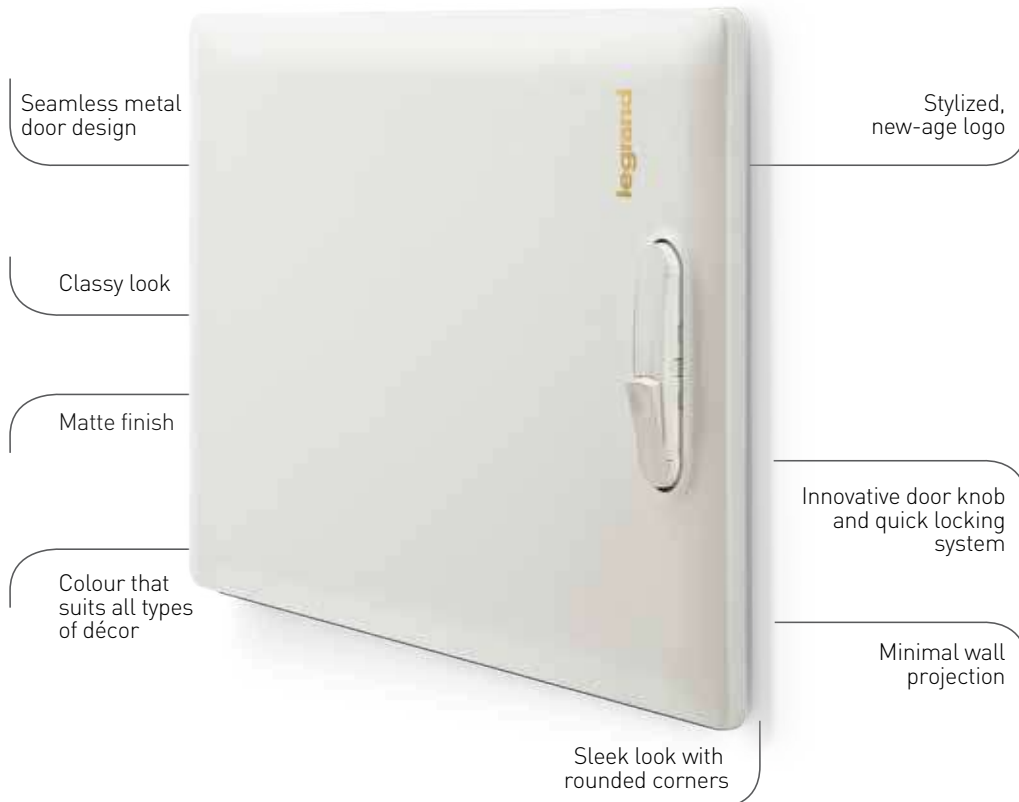

Scan to know more about the product.



Features and benefits

Maximum reliability & excellent safety-
Designed in accordance with IEC 61439-3



Integrated earthing system in order to avert risky contact



Completely insulated bus bars guarantee safety from severe shocks

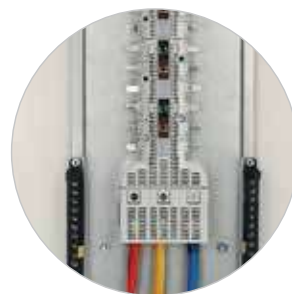

Shrouded neutral bars and insulated din rail for complete isolation



Reversible door can be easily removed



Normal lock convertible to key lock, so that it isn't tampered with



Colour-coded neutral bars for easy identification



Plastic plugs for mounting holes

Ekinox³™

Distribution Board

Built for Mivan Construction Environments



The Ekinox³ Mivan Compatible Distribution Board is designed to simplify electrical installations in modern Mivan construction projects. Its robust construction and compact form factor support reliable installation within concrete wall systems while maintaining a clean and minimal appearance for finished interiors.

Scan to know more about the product.



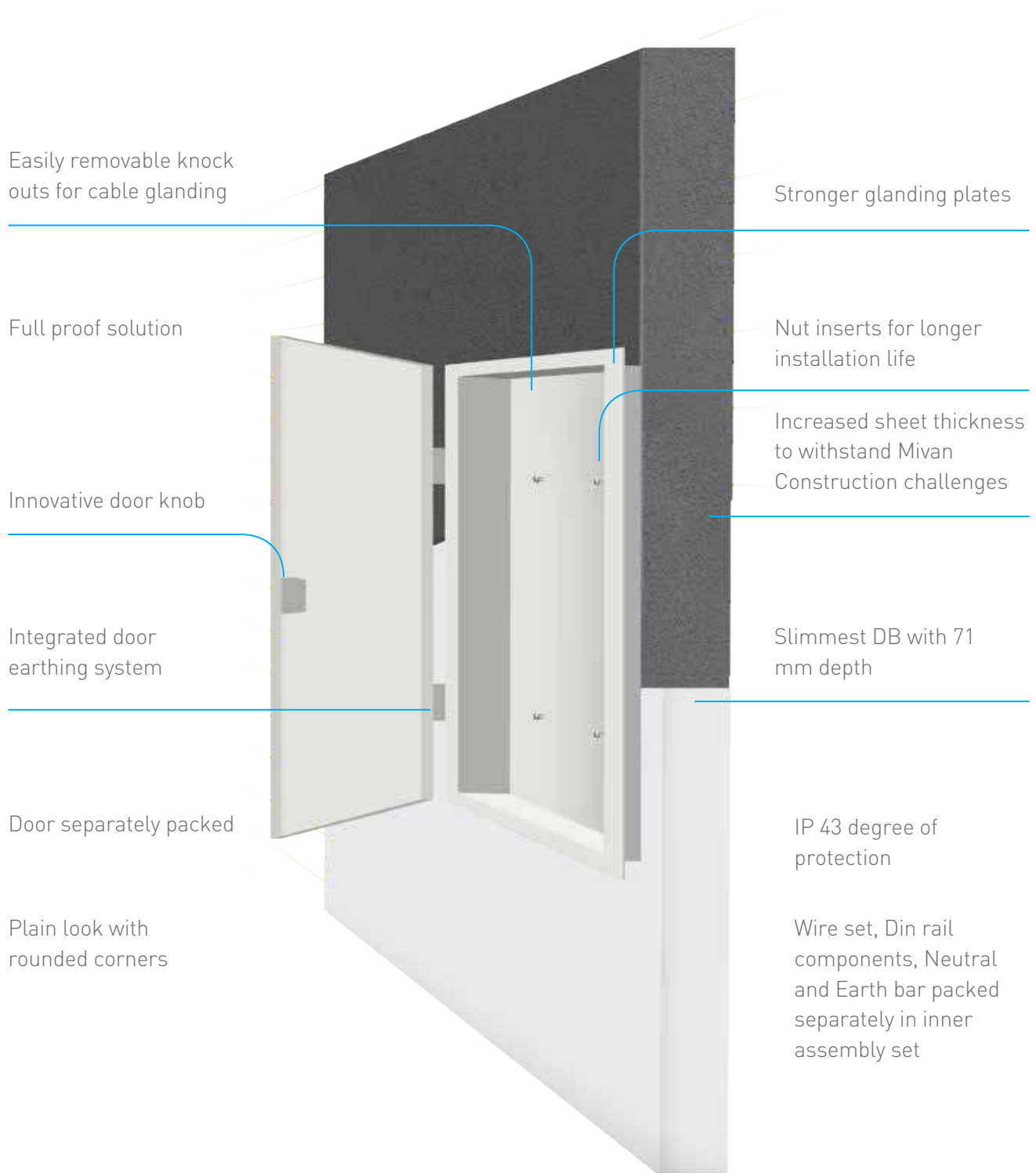

Ekinox³ SPN DB's

For DX³ MCB, Isolator, RCCB and RCBO

Cat.Nos	Number ofWs	No. of modules	MRP* ₹ / Unit	Pack
---------	-------------	----------------	---------------	------

- As per IEC 61439-3
- Suitable for Flush Mounting and Surface Mounting
- With 100 A Copper Busbar
- With Neutral bar, Earthbar and Cable ties for Cable management
- Fully shrouded Neutral bars
- Prefitted masking sheet
- Reversible Door for IP 43 & IP 54 DB's

IP 30 - #IK 08

5076 00	4W	4	2128	1
5076 01	8W	8	2581	1
5076 02	12W	12	3050	1
5076 03	16W	16	3726	1
5076 04	18W	18	4334	1
5076 05	20W	20	4834	1



5076 05



5076 12

IP 43 - #IK 09 with Metal Door

5076 10	4W	4	2788	1
5076 11	8W	8	3597	1
5076 12	12W	12	4322	1
5076 13	16W	16	5415	1
5076 14	18W	18	5690	1
5076 15	20W	20	6573	1

IP 43 - #IK 09 with Acrylic Door

5076 20	4W	4	3726	1
5076 21	8W	8	4316	1
5076 22	12W	12	5245	1
5076 23	16W	16	6514	1
5076 24	18W	18	6815	1
5076 25	20W	20	7216	1



5076 42

IP 54 - #IK 09

5076 40	4W	4	9579	1
5076 41	8W	8	11386	1
5076 42	12W	12	13080	1
5076 43	16W	16	14525	1
5076 44	18W	18	14684	1
5076 45	20W	20	15958	1

Ekinox³ ETPN DB's

For DX³ MCB, Isolator, RCCB and RCBO

- As per IEC 61439-3
- Suitable for Flush Mounting and Surface Mounting
- With 100 A Copper Busbar for each phase
- With Neutral bar, Earthbar and Cable ties for Cable management
- Fully insulated busbar & shrouded Neutral bars
- Improved Pan assembly for ease of installation
- Prefitted masking sheet
- Reversible Door for IP 43 & IP 54 DB's
- With provision for FP MCB/Isolator/RCCB/RCBO as incomer and SP MCB's as outgoing
- Supplied with wireset
- Can be converted to PPI DB at site using conversion kit

IP 30 - #IK 08

5076 60	4W	8+12	6131	1
5076 61	6W	8+18	7605	1
5076 62	8W	8+24	8981	1
5076 63	12W	8+36	12805	1
5076 64	16W	8+48	15596	1
5076 66	20W	8+60	21766	1



5076 61



5076 82



5077 01



5077 11

Ekinox³ ETPN DB's

For DX³ MCB, Isolator, RCCB and RCBO

Cat.Nos	Number ofWs	No. of modules	MRP* ₹ / Unit	Pack
---------	-------------	----------------	---------------	------

IP 43 - #IK 09 with Metal Door

5076 70	4W	8+12	7335	1
5076 71	6W	8+18	8841	1
5076 72	8W	8+24	10593	1
5076 73	12W	8+36	15709	1
5076 74	16W	8+48	19664	1
5076 76	20W	8+60	27398	1

IP 43 - #IK 09 with Acrylic Door

5076 80	4W	8+12	9237	1
5076 81	6W	8+18	11292	1
5076 82	8W	8+24	13289	1
5076 83	12W	8+36	20584	1
5076 84	16W	8+48	24787	1
5076 86	20W	8+60	33509	1

IP 54 - #IK 09

5076 90	4W	8+12	22966	1
5076 91	6W	8+18	27636	1
5076 92	8W	8+24	30224	1
5076 93	12W	8+36	43009	1
5076 94	16W	8+48	51114	1
5076 96	20W	8+60	60809	1

Ekinox³ Flexy DB

For DX³ DIN Modular Products

Cat.Nos	Number of row	No. of modules	MRP* ₹ / Unit	Pack
---------	---------------	----------------	---------------	------

- As per IEC 61439-3
- Suitable for Flush Mounting and Surface Mounting
- Completely flexible to organise the distribution as per site requirements
- Busbars to be selected as per distribution requirements
- With Neutral and Earth bars
- Fully shrouded Neutral bars
- Improved Pan assembly for ease of installation
- Prefitted masking sheet
- Reversible door for IP 43

IP 30 - #IK 08

5077 01	2 row of 14 M	28	7433	1
5077 02	3 row of 14 M	42	9304	1
5077 03	4 row of 14 M	56	10317	1

IP 43 - #IK 09 with Metal Door

5077 05	2 row of 14 M	28	9362	1
5077 06	3 row of 4 M	42	11191	1
5077 07	4 row of 14 M	56	12133	1
5077 14	4 row of 8 M	32	10351	1
5077 15	4 row of 10 M	40	10835	1
5077 12	3 row of 14 M MCCB for DPX ³ 160 MCCB	42	12881	1

IP 43 - #IK 09 with Acrylic Door

5077 09	2 row of 14 M	28	9874	1
5077 10	3 row of 14 M	42	12135	1
5077 11	4 row of 14 M	56	13749	1
5077 13	3 row of 14 M MCCB for DPX ³ 160 MCCB	42	14330	1

Bold Cat.Nos are products normally available with Legrand (India) Stockists. Cat.Nos that are not bold - delivery within 4 - 8 weeks from the date of order. Bold packing quantity is our mandatory packing. Orders to be placed by Legrand (India) Stockist in multiples of the same.

* MRP - Maximum Retail Price Inclusive of all taxes including GST.
#IK - Refer pg - 59 for ready reckoner table.

Ekinox³ TPN DB-VTPN DB's For DX³ MCB, Isolator, RCCB and RCBO

Cat.Nos	Number of Ws	No. of modules	MRP* ₹ / Unit	Pack
---------	--------------	----------------	---------------	------

- As per IEC 61439-3
- Suitable for Flush Mounting and Surface Mounting
- With 100 A Copper Busbar for each phase
- With 2 Neutral bar, 2 Earthbar and Cable ties for Cable management
- Fully insulated busbar & shrouded Neutral bars
- Improved Pan assembly for ease of installation
- Prefitted masking sheet
- Reversible Door for IP 43 & IP 54 DB's
- With provision for FP MCB/Isolator/RCCB/RCBO as incomer and SP/TP MCB's as outgoing

IP 30 - #IK 08

5077 20	4W	8+12	16452	1
5077 21	6W	8+18	18055	1
5077 22	8W	8+24	20084	1
5077 23	12W	8+36	28998	1

IP 43 - #IK 09 with Metal Door

5077 25	4W	8+12	17350	1
5077 26	6W	8+18	19215	1
5077 27	8W	8+24	22365	1
5077 28	12W	8+36	30090	1

IP 43 - #IK 09 with Acrylic Door

5077 30	4W	8+12	22512	1
5077 31	6W	8+18	24770	1
5077 32	8W	8+24	28964	1
5077 33	12W	8+36	38641	1

IP 54 - #IK 09

5077 35	4W	8+12	36085	1
5077 36	6W	8+18	39236	1
5077 37	8W	8+24	43403	1
5077 38	12W	8+36	56188	1

Ekinox³ TPN DB-VTPN DPX³ 160 MCCB DB's

- As per IEC 61439-3
- Suitable for Flush Mounting and Surface Mounting
- With 250 A Copper Busbar for each phase
- With 2 Neutral bar, 2 Earthbar and Cable ties for Cable management
- Fully insulated busbar & shrouded Neutral bars
- Improved Pan assembly for ease of installation
- Prefitted masking sheet
- Reversible Door for IP 43 & IP 54 DB's
- With provision for DPX³ 160 MCCB as incomer and SP/TP MCB's as outgoing

IP 30 - #IK 08

5077 40	4W	DPX ³ 160+12	18457	1
5077 41	6W	DPX ³ 160+18	19741	1
5077 42	8W	DPX ³ 160+24	21497	1
5077 43	12W	DPX ³ 160+36	32562	1

* MRP - Maximum Retail Price Inclusive of all taxes including GST.
#IK - Refer pg - 59 for ready reckoner table.
■ Price available on request.

Ekinox³ TPN DB-VTPN DPX³ 160 MCCB DB's

Cat.Nos	Number of Ws	No. of modules	MRP* ₹ / Unit	Pack
---------	--------------	----------------	---------------	------

IP 43 - #IK 09 with Metal Door

5077 45	4W	DPX ³ 160+12	21185	1
5077 46	6W	DPX ³ 160+18	24044	1
5077 47	8W	DPX ³ 160+24	26489	1
5077 48	12W	DPX ³ 160+36	36113	1

IP 54 - #IK 09

5077 50	4W	DPX ³ 160+12	42348	1
5077 51	6W	DPX ³ 160+18	48219	1
5077 52	8W	DPX ³ 160+24	52387	1
5077 53	12W	DPX ³ 160+36	69016	1

Ekinox³ TPN DB-VTPN DPX³ 250 MCCB DB's

- As per IEC 61439-3
- Suitable for Flush Mounting and Surface Mounting
- With 250 A Copper Busbar for each phase
- With 2 Neutral bar, 2 Earthbar and Cable ties for Cable management
- Fully insulated busbar & shrouded Neutral bars
- Improved Pan assembly for ease of installation
- Prefitted masking sheet
- Reversible Door for IP 43 & IP 54 DB's
- With provision for DPX³ 250 MCCB as incomer and SP/TP MCB's as outgoing

IP 30 - #IK 08

5077 55	4W	DPX ³ 250+12	29552	1
5077 56	8W	DPX ³ 250+24	31416	1
5077 57	12W	DPX ³ 250+36	34675	1

IP 43 - #IK 09 with Metal Door

5077 58	4W	DPX ³ 250+12	32495	1
5077 59	8W	DPX ³ 250+24	34268	1
5077 60	12W	DPX ³ 250+36	38723	1

IP 54 - #IK 09

5077 61	4W	DPX ³ 250+12	49957	1
5077 62	8W	DPX ³ 250+24	57090	1
5077 63	12W	DPX ³ 250+36	66715	1

Bold Cat.Nos are products normally available with Legrand (India) Stockists. Cat.Nos that are not bold - delivery within 4 - 8 weeks from the date of order. Bold packing quantity is our mandatory packing. Orders to be placed by Legrand (India) Stockist in multiples of the same.



5077 20



5077 31



5077 53



5077 55

Ekinox³ Mivan DB

Cat.Nos	Number of Ws	No. of modules	MRP* ₹ / Unit	Pack
---------	--------------	----------------	------------------	------

Ekinox³ Mivan SPN DB

- As per IEC 61439-3
- Suitable for Mivan Construction
- With 100 A Copper Busbar
- With Neutral bar, Earthbar and Cable ties for Cable
- Fully shrouded Neutral bars
- Reversible Door

IP 43 - #IK 09 with Metal Door

5076 10M	4W	4	3029	1
5076 11M	8W	8	3967	1
5076 12M	12W	12	4975	1
5076 13M	16W	16	6038	1
5076 15M	20W	20	7572	1



5076 12

Ekinox³ Mivan ETPN DB

- As per IEC 61439-3
- Suitable for Mivan Construction
- With 100 A Copper Busbar
- With Neutral bar, Earthbar and Cable ties for Cable
- Fully shrouded Neutral bars
- Reversible Door

IP 43 - #IK 09 with Metal Door

Cat.Nos	Description	No. of modules	MRP* ₹ / Unit	Pack
5076 70M	4W ETPN IP43 Mivan DB	8+12	7234	1
5076 71M	6W ETPN IP43 MIVAN DB	8+18	9967	1
5076 72M	8W ETPN IP43 MIVAN DB	8+24	11957	1
5076 73M	12W ETPN IP43 MIVAN DB	8+36	17568	1

- * MRP - Maximum Retail Price Inclusive of all taxes including GST.
- Price available on request.

Ekinox³ PPI DB

Cat.Nos	Description	MRP* ₹ / Unit
---------	-------------	------------------

5076 70P	4W ETPN IP43 PPI DB	■
5076 71P	6W ETPN IP43 PPI DB	■
5076 72P	8W ETPN IP43 PPI DB	■
5076 73P	12W ETPN IP43 PPI DB	■
5076 74P	16W ETPN IP43 PPI DB	■
5076 76P	20W ETPN IP43 PPI DB	■

Bold Cat.Nos are products normally available with Legrand (India) Stockists. Cat.Nos that are not bold - delivery within 4 - 8 weeks from the date of order. Bold packing quantity is our mandatory packing. Orders to be placed by Legrand (India) Stockist in multiples of the same.

NEO

Distribution Boards

Sturdy & Robust Electrical Solution



Phase Selector Neo

Highly Compact

Sleek design

Easy to install –
4 way construction Separate Door,
Shield, Frame & Backbox

Integrated LED indication in the
selector switches

IP 43 protection

Robust Design
with - IK 09



8 Segment Neo DB

Compact

Sturdy & Robust design

Colour coded Neutral Bar's

Ease of Installation with
Detachable frame

8/7 compartments

Additional knockouts for
ease of wiring

Representative Wiring
Diagram on Door

IP42 & IK09



Scan to know more about
the product.

NEO DB

Cat.Nos	Description	MRP* ₹ / Unit	Pack
---------	-------------	------------------	------

Phase Selector Neo DB

- As per IEC 61439-3
- Compact and sleek design
- IP 43 protection & IK 09
- Integrated LED indication in the selector switches
- With 100A copper busbar for each phase
- Fully insulated busbar & shrouded Neutral bars

5077 80N	4W NEO	19049	1
5077 81N	6W NEO	19357	1
5077 82N	8W NEO	20737	1
5077 83N	12W NEO	23354	1



5077 81N

8 Segment Neo DB

IP 42 - #IK 09 with Metal Door

- As per IEC 61439-3
- DB with phase segmentation and separation between Incomer and Outgoings
- Sturdy & Robust design
- With 100A copper busbar for each phase
- Colour coded Neutral Bars
- Easy to Install : Detachable frame
- 8 compartments
- More number of knockouts
- IP42 & IK09
- Supplied with wire-set
- With provision for DPX³ 160 MCCB as incomer DP MCB/Isolator/RCCB/RCBO as sub incomers and SP MCB's as outgoing

5078 85N	4W 8/7S IP42 Neo	14681	1
5078 86N	6W 8/7S IP42 Neo	16447	1
5078 87N	8W 8/7S IP42 Neo	18423	1
5078 88N	12W 8/7S IP42 Neo	22936	1



5078 86N

IP 42- #IK09 Suitable for 160A DPX³ MCCB as Incomer

5078 95N	4W 8/7S 160A MCCB IP42 Neo	20380	1
5078 96N	6W 8/7S 160A MCCB IP42 Neo	23313	1
5078 97N	8W 8/7S 160A MCCB IP42 Neo	26942	1
5078 98N	12W 8/7S 160A MCCB IP42 Neo	30418	1

Ekinox³ Metal Enclosures for DX³ MCB, RCCB, RCBO and DPX³ MCCB's

- As per IEC 61439-3
- Suitable for Flush Mounting and Surface Mounting
- Suitable for protection of appliances like AC/Geyser etc
- Supplied with Neutral Links
- With provision for mounting modular devices

#IK 08

5078 10	10 A SP, 2P+E	1	2771	1
5078 11	20 A SP, 2P+E	1	2985	1
5078 14	20 A DP, 2P+E	2	3243	1
5078 17	20 A TP, 3P+E	3	5494	1
5078 18	32 A TP, 3P+E	3	6518	1
5078 20	20 A DP RCBO, 2P+E	4	3137	1
5078 21	20 A FP RCBO, 2P+E	8	5485	1
5078 22	32 A FP RCBO, 3P+E	8	6466	1



5078 14



5078 22

* MRP - Maximum Retail Price Inclusive of all taxes including GST.
 # Price available on request.
 #IK - Refer pg - 59 for ready reckoner table.

Ekinox³ Metal Enclosures

Cat.Nos	Description	No. of modules	MRP* ₹ / Unit	Pack
---------	-------------	----------------	------------------	------

- As per IEC 61439-3
- Suitable for Flush Mounting and Surface Mounting
- Supplied with Neutral Links
- With provision for mounting modular devices

#IK 08

5078 60	16 A 2P+E-DP	2	4525	1
5078 63	32 A 2P+E-DP	2	4891	1
5078 61	32 A 3P+E-FP	8	8188	1
5078 62	32 A 3P+N+E-FP	8	8283	1
5078 64	63 A 3P+N+E-FP	8	20618	1



5078 62



5078 64



5077 91



5077 93

Ekinox³ Metal Enclosures for DX³ MCB, RCCB, RCBO & DPX³ MCCB's

- As per IEC 61439-3
- For independent mounting of DX³ MCB, RCCB, RCBO, DPX³ 160, DPX³ 250, DPX³ 630 & DRX MCCB's
- #IK 08

#IK 08

5077 90	SP enclosure	1	761	1
5077 91	DP enclosure	2	1097	1
5077 92	TP enclosure	3	1097	1
5077 93	FP enclosure	4	1097	1
5077 94	FP RCBO enclosure	8	1835	1

Metal One Way Enclosures for MCCB

5078 01	DPX ³ 160 MCCB enclosure	3&4	6242	1
5078 02	DPX ³ 250 MCCB enclosure	3&4	10976	1
5078 04	DPX ³ 630 MCCB enclosure	3&4	17050	1
5078 05	DRX 100 MCCB enclosure-TP	3	3370	1
5078 06	DRX 100 MCCB enclosure-FP	4	3370	1

Ekinox³ Cable End Box

- Useful for keeping extra cables
- Possible to mount on the top or bottom of the DB
- Provision for mounting terminal blocks
- Can be used as a terminal box adaptor also

For IP 30 DB's

5079 10	For SPN 4 W IP30	1111	1
5079 12	For SPN 8 W IP30	1288	1
5079 14	For SPN 12 W/ VTPN/Flexy	1456	1
5079 16	For SPN 16 W/ ETPN 6W DB	2045	1
5079 25	For ETPN 8W DB	3673	1
5079 27	For ETPN 12W DB	4756	1
5079 29	For ETPN 16W DB	4850	1
5079 31	For ETPN 18W DB	5021	1
5079 33	For ETPN 20W DB	5198	1
5079 35	For ETPN 4W VTPN/FLEXY MCB	1442	1
5079 37	For all VTPN MCCB DBS	5313	1



5079 12

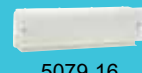

5079 16



5079 27

For IP 43 DB's

5079 11	For SPN 4W DB	1272	1
5079 13	For SPN 8W DB	1553	1
5079 15	For SPN 12W/ VTPN/Flexy DB	1741	1

Bold Cat.Nos are products normally available with Legrand (India) Stockists. Cat.Nos that are not bold - delivery within 4 - 8 weeks from the date of order. Bold packing quantity is our mandatory packing. Orders to be placed by Legrand (India) Stockist in multiples of the same.

Ekinox³ Metal Enclosures

Cat.Nos	Description	MRP* ₹ / Unit	Pack
---------	-------------	------------------	------

For IP 43 DB's

5079 17	For SPN 16W/ ETPN 6W DB	2473	1
5079 18	For SPN 18W DB	2475	1
5079 19	For SPN 20/ETPN 8W DB	2585	1
5079 28	For ETPN 12W DB	5550	1
5079 30	For ETPN 16W DB	5656	1
5079 32	For ETPN 18W DB	5766	1
5079 34	For ETPN 20W DB	6100	1
5079 36	For all ETPN 4W/VTPN/Flexy MCB	1741	1
5079 38	For all VTPN MCCB DBs	6182	1

Ekinox³ DBs

Meter Box

- Suitable for Mounting DX³ Metering products
- Possible to mount on the top or bottom of the DB
- Provision for mounting Ammeter/Voltmeter/ASS/VSS
- #IK09

Provision for Mounting Meters

5079 40	For VTPN MCB INCOM IP 30	6847	1
5079 41	For VTPN MCB INCOM IP 43	8402	1
5079 42	For VTPN MCCB INCOM IP 30	7615	1
5079 43	For VTPN MCCB INCOM IP 43	9697	1



5079 43

Per Phase Isolation Kit

5079 44	PPI conversion kit for ETPN 4W DB	4294	1
5079 45	PPI conversion kit for ETPN 6W DB	4842	1
5079 46	PPI conversion kit for ETPN 8W DB	5520	1
5079 47	PPI conversion kit for ETPN 12W DB	6212	1
5079 48	PPI conversion kit for ETPN 16W DB	6946	1

Panel Locks

5079 52	Panel knob for IP 43	474	1
5079 51	Panel knob with key	989	1

Distribution Boards Accessories

Cat.Nos	No. of devices connected	No. of 17.5 mm modules	MRP* ₹ / Unit	Pack
---------	--------------------------	------------------------	------------------	------

Supply Busbars - Insulated

63 A Copper
Pin Type

SP I/C & SP O/G

4049 26	13	13	515	1
4049 37	57	57	2001	1



- * MRP - Maximum Retail Price Inclusive of all taxes including GST.
- ▼ Compatible with Ekinox3 and NEO DB.
- #IK - Refer pg - 59 for ready reckoner table.

Distribution Boards

Cat.Nos	Description	MRP* ₹ / Unit	Pack
---------	-------------	------------------	------

SPN I/C & SPN O/G

4049 46	6	12	904	1
4049 47	28	56	3740	1

TPN I/C & SPN O/G

4049 48	5	12	929	3/30
4049 50	27	56	9129	5/10

TP I/C & TP O/G

4049 51	4	12	936	1
4049 52	19	57	9177	1

FP I/C & FP O/G

4049 54	3	12	2254	3/30
4049 55	14	56	9129	5/10

Fork Type SP I/C & SP O/G

4049 56	13	12	515	1
4049 57	57	57	1964	1

SPN I/C & SPN O/G250

4049 59	28	56	3740	1
---------	----	----	------	---

TP I/C & TP O/G

4049 63	4	12	929	1
4049 64	19	57	4694	1

FP I/C & FP O/G

4049 36	14	56	9129	5/10
---------	----	----	------	------

Accessories for Fork and Pin Type Busbars

Cat.Nos	No. of devices connected	No. of 17.5 mm modules	MRP* ₹ / Unit	Pack
4049 89	End caps for SP	6	9	5/10



Blanking Plates

Cat.Nos	Number of Ws	MRP* ₹ / Unit	Pack
6014 70	-	21	10



Bold Cat.Nos are products normally available with Legrand (India) Stockists. Cat.Nos that are not bold - delivery within 4 - 8 weeks from the date of order. Bold packing quantity is our mandatory packing. Orders to be placed by Legrand (India) Stockist in multiples of the same.

Plexo³ Boxes for DX³

Cat.Nos	Number ofWs	MRP* ₹ / Unit	Pack
---------	-------------	------------------	------

Self-extinguishing: resistance to incandescent wire 650 °C
 Conform to EN 60439-3
 Weatherproof cabinets - IP 65 - IK 09 - Class II
 Door and cabinet fully reversible
 Removable chassis and faceplates from 2-row versions up
 2-position rail for modular products and moulded cases
 Spacing between rails 150 mm
 Box colour light grey L750A, cover colour dark grey
 R746A

6019 32	2 (+1) Module	2581	1
6019 94	4 Module	2790	1
6019 96	6 Module	3186	1
6019 98	8 Module	3981	1

Cabinets with 12 modules per row

6018 31	1 row 12 modules	6270	1
6018 32	2 rows 24 modules	8699	1
6018 33	3 rows 36 modules	12123	1

Cabinets with 18 modules per row

6018 35	18 modules x 1 row	7733	1
6018 36	18 modules x 2 rows	13381	1
6018 37	18 modules x 3 rows	18814	1
6018 38	18 modules x 4 rows	28159	1

Multifunction sleeves for P17

0019 17	For 2 row cabinets	4973	1
0019 18	For 3 row cabinets	7454	1
0019 67	Joining kit	1408	1

Plexo-S

6018 82	Waterproof cabinet 2M	2063	1
6018 84	Waterproof cabinet 4M	2429	1
6018 86	Waterproof cabinet 6M	2792	1
6018 88	Waterproof cabinet 8M	3436	1
6018 92	Waterproof cabinet 12M	5511	1
6018 94	Waterproof cabinet 24M	7590	1

* MRP - Maximum Retail Price Inclusive of all taxes including GST.
 Refer instruction manual for MIVAN (Aluminum shuttering) compatible DB's
 ■ Price available on request.

Note: For Plexo3 Box with integrated Neutral & Earth Bars contact nearest Sales Office

Accessories

Fixing Lugs And Blanking Plates

Cat.Nos	Number ofWs	MRP* ₹ / Unit	Pack
---------	-------------	------------------	------

0019 69	Set of 4 wall mounting lugs for Plexo, Plexo ³ cabinets and P 17 combined units	■	1
0019 61	5, seperable into modules or 1/2 module Grey RAL 7046	■	20

Direct Piercing End Caps

0019 56	Pack consisting of 100 ø20 mm ISO and caps	■	1
0019 57	Pack consisting of 100 ø25 mm ISO and caps	■	1

Earth Terminal & Neutral Terminal Blocks

Brass terminal block with isolated support conform to IEC 60998-2-1/2-2

1348 00	1 X (2x162 + 2x102); ICC : 6kA	■	1
1348 01	1 X (3x162 + 3x102); ICC : 6kA	■	1
1348 10	2 X (2x162 + 2x102); ICC : 6kA	■	1
1348 11	2 X (3x162 + 3x102); ICC : 6kA	■	1

Bold Cat.Nos are products normally available with Legrand (India) Stockists. Cat.Nos that are not bold - delivery within 4 - 8 weeks from the date of order. Bold packing quantity is our mandatory packing. Orders to be placed by Legrand (India) Stockist in multiples of the same.

PLEXO

Weatherproof Enclosures

The Go-To Range for Reliable Outdoor Installations



PLEXO enclosures deliver durable, weatherproof protection for modular electrical installations across indoor and outdoor environments. Featuring award-winning design, quick snap-fit assembly, and flexible configurations, they ensure faster installations and reliable performance in demanding site conditions.

Features

- Reversible modular design supporting 1–7 module configurations with transparent or opaque covers
- Tool-free snap-fit assembly for quick installation and flexible alignment
- High protection ratings with IP55–IP66 sealing and IK07–IK09 impact resistance
- Durable, eco-compliant materials with 650°C self-extinguishing capability

Benefits

- Reduces installation time with fast snap-fit mounting and flexible wiring space
- Performs reliably in harsh environments like garages, car parks, and wash areas
- Enables quick visual inspection using transparent protective covers
- Supports scalable installations with modular designs and smart-ready options



Scan to know more about the product.



Ekinox³ For Converting ETPN DB to PPI DB

PPI DB IP 30 - IK 08

No. of ways	Combine		No. of modules
	ETPN DB	PPI Kit	
4 way	4 way 507660	4 way kit 507944	8+12
6 way	6 way 507661	6 way kit 507945	8+18
8 way	8 way 507662	8 way kit 507946	8+24
12 way	12 way 507663	12 way kit 507947	8+36
16 way	16 way 507664	16 way kit 507948	8+48

PPI DB IP 43 - IK 09 with metal door

No. of ways	Combine		No. of modules
	ETPN DB	PPI Kit	
4 way	4 way 507670	4 way kit 507944	8+12
6 way	6 way 507671	6 way kit 507945	8+18
8 way	8 way 507672	8 way kit 507946	8+24
12 way	12 way 507673	12 way kit 507947	8+36
16 way	16 way 507674	16 way kit 507948	8+48

PPI DB IP 43 - IK 09 with acrylic door

No. of ways	Combine		No. of modules
	ETPN DB	PPI Kit	
4 way	4 way 507680	4 way kit 507944	8+12
6 way	6 way 507681	6 way kit 507945	8+18
8 way	8 way 507682	8 way kit 507946	8+24
12 way	12 way 507683	12 way kit 507947	8+36
16 way	16 way 507684	16 way kit 507948	8+48

PPI DB IP 54 - IK 09

No. of ways	Combine		No. of modules
	ETPN DB	PPI Kit	
4 way	4 way 507690	4 way kit 507944	8+12
6 way	6 way 507691	6 way kit 507945	8+18
8 way	8 way 507692	8 way kit 507946	8+24
12 way	12 way 507693	12 way kit 507947	8+36
16 way	16 way 507694	16 way kit 507948	8+48

IK

Protection against mechanical impact: protection index - IK

According to standard:

IEC 62262, BS EN 62262 and NF EN 62262

• This table can be used to ascertain the resistance of a product to an impact given in Joules from the IK code (graduated from 00 to 10)

It can also be used to ascertain the correspondence with the old IP code 3rd digit and the corresponding external "Ag" conditions

IK	Tests	Impact energy (in Joules)	"AG" of NF C 15-100
IK 00		0	
IK 01		0.15	
IK 02		0.2	AG1
IK 03		0.35	
IK 04		0.5	
IK 05		0.7	
IK 06		1	
IK 07		2	AG2
IK 08		5	AG3
IK 09		10	
IK 10		20	AG4

IPXX

Index of protection

IP*** index of protection of enclosures of electrical equipment in accordance with standards IEC 529, BS 5490, DIN 400 50 and NF C 20-010
Up to 1000 V± and 1500 V= (standard UTE C 20 010)

1st figure:- protection against solid bodies

IP	tests	
0		No protection
1		Protected against solid bodies larger than 50 mm (eg:- accidental contact with the hand)
2		Protected against solid bodies larger than 12 mm (eg:- finger)
3		Protected against solid bodies larger than 2.5 mm (eg:- tools, wires)
4		Protected against solid bodies larger than 1 mm (eg:- fine tools and small wires)
5		Protected against dust (no harmful deposit)
6		Completely protected against dust

2nd figure:- protection against liquids

IP	tests	
0		No protection
1		Protected against vertically-falling drops of water (condensation)
2		Protected against drops of water falling at up to 15° from the vertical
3		Protected against drops of rain water at up to 60° from the vertical
4		Protected against projections of water from all directions
5		Protected against jets of water from all directions
6		Protected against jets of water of similar force to heavy seas
7		Protected against the effects of immersion
8		Protected against prolonged effects of immersion under pressure

The contents of all the above charts are for guidance only, if you have any doubt as to the interpretation of the information contained therein, please refer either to the standard itself or contact Legrand.

In accordance with our policy of continuous improvement, Legrand reserves the right to change specifications and designs without notice. All information given here is correct at the time of going to press.

XCP-HP

Sandwich BBT

The High Performance Power Solution for Data Center Building & Industrial Application



XCP Sandwich Busbar Trunking is a compact power distribution system designed for high-current applications in large infrastructures such as skyscrapers, banks, data centers, and commercial buildings. Its sandwich construction enables efficient, safe, and reliable power distribution in space-constrained installations.

Features

- Wide current range from 630A to 6300A with copper and aluminium conductor options
- Designed for 50°C ambient condition
- Fire resistance up to 3 hours @830°C (IEC 60331-4) with high impact protection
- Halogen free
- Fully tested as per IEC 61439-6 standards
- Mechanical Impact tested IK10

Benefits

- Ensures safe and reliable power distribution in high-load buildings
- Optimises electrical riser and shaft space in large installations
- Minimises maintenance through durable, corrosion-resistant construction
- Supports faster project approvals with internationally compliant testing and performance standards

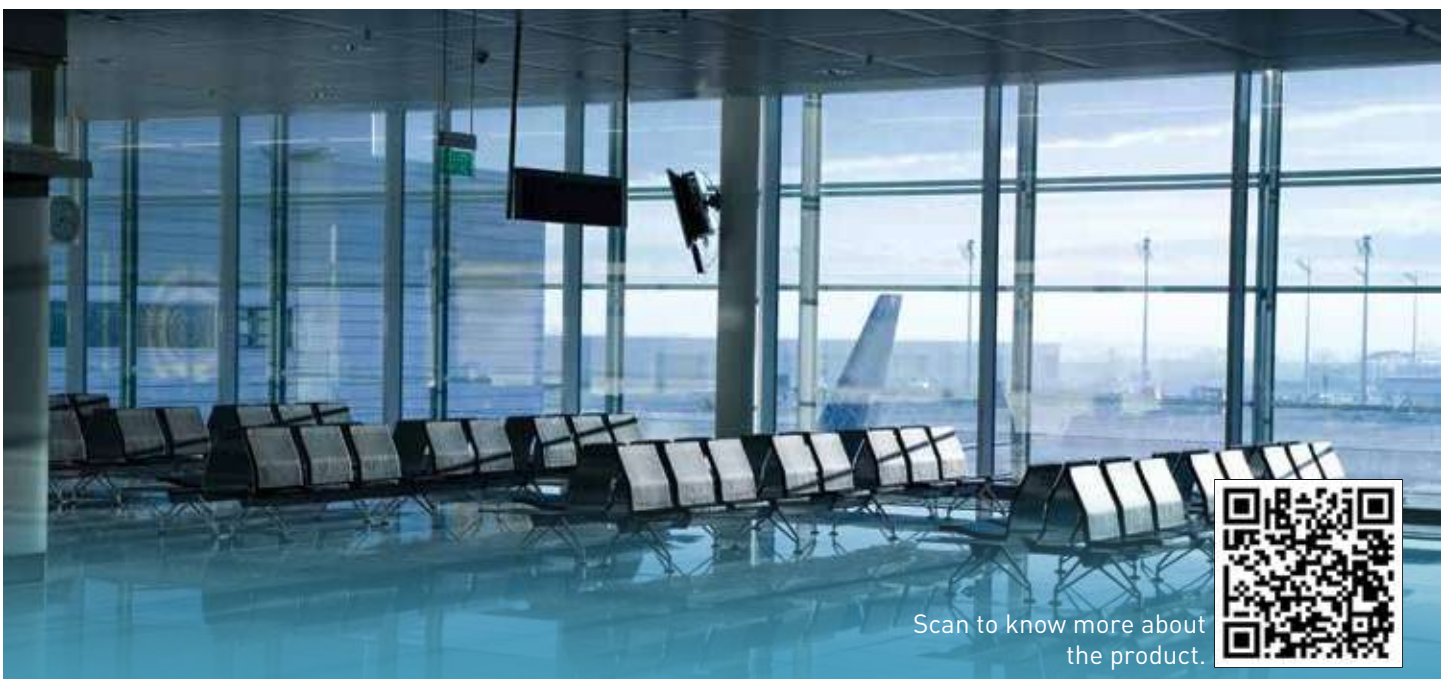

Scan to know more about the product.



ARTEOR™ ADVANCE

FEEL SOMETHING NEW

Premium Wiring Devices for Fine Living



Arteor™ Advance is a premium wiring device range designed for luxury residences, offices, and hospitality spaces. It combines refined aesthetics, innovative mechanisms, and smart connectivity to deliver elegant functionality for modern interiors.

Features

- Dual rocker styles with Classic and Elite designs
- Premium finish collections including Matt, Decor, Metal, and Statement full-metal plates
- Integrated plate adjuster for precise alignment on uneven walls
- Smart-ready features such as contactless switches, motion sensors, and hotel keycard controls

Benefits

- Elevates interior design with premium finishes and modern styling
- Supports connected living with integrated charging and smart control options
- Provides versatile solutions for residential, office, and hospitality spaces
- Ensures long-lasting performance with durable aluminium plates and refined build quality



Celebrating Design That Elevates Every Space



Scan to know more about
the product.



ARTEOR™
ADVANCE
FEEL SOMETHING NEW

Two Forms, One Design Concept

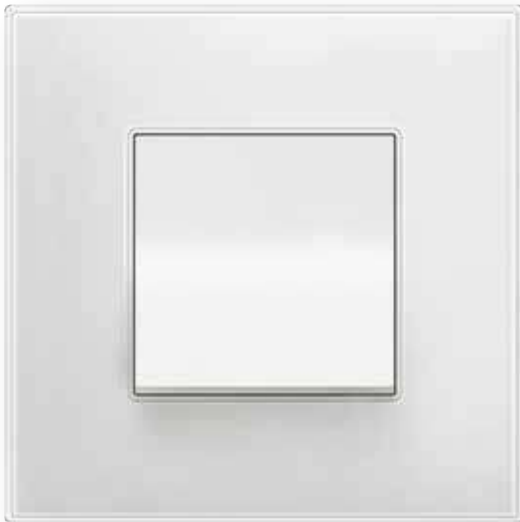

CLASSIC

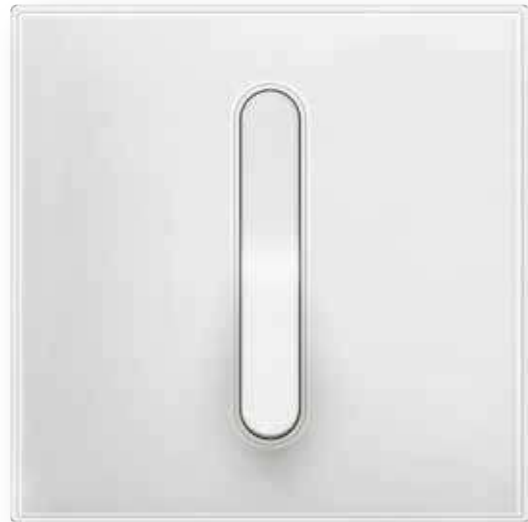

ELITE

Design language

Arteor Advance is available in two design lines, with clearly different rocker formats. The Classic design gives a whole new dimension to a classic form. The Elite rocker is a completely new design embodying the trends of the future.

Floating rocker

The impression created by the floating rocker is the same for both types: Light and elegant, it seems to float above the plate. Both forms can be combined to great effect as well. The Elite version allows you to make a clear statement, while the Classic version is more subtle and discreet.

FINISHES

Statement Collection
FULL METAL

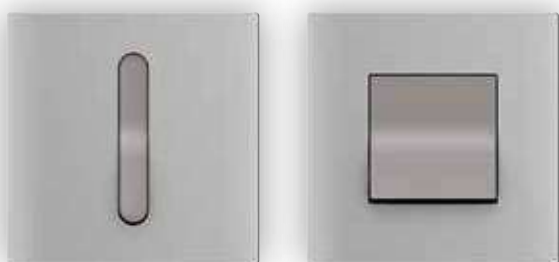

Decor Collection
FROSTED FINISHES



Classic Collection
BASIC NEUTRAL



Decor Collection
Metal Finishes

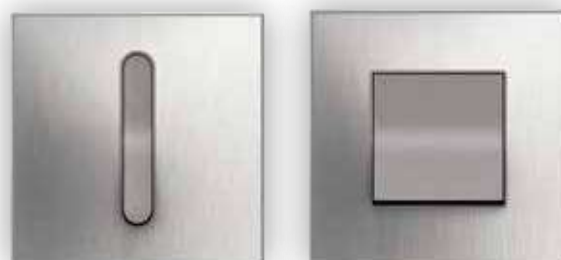

ARTEOR™ ADVANCE

FEEL SOMETHING NEW

Modular Design for Maximum Flexibility

The modular architecture of the range allows to integrate a wide range of different functions within a single plate, whatever the installation standard.



Even where space is scarce, individual configurations are possible.



Full modularity for maximum flexibility.

One Plate, Two Designs – Perfect Integration

Modularity is also maintained when you want to use both ergonomics, Classic and Elite in one plate. Thanks to special hybrid plates, both design lines can be combined in one plate at the same time, for more creative possibilities with a harmonious look.

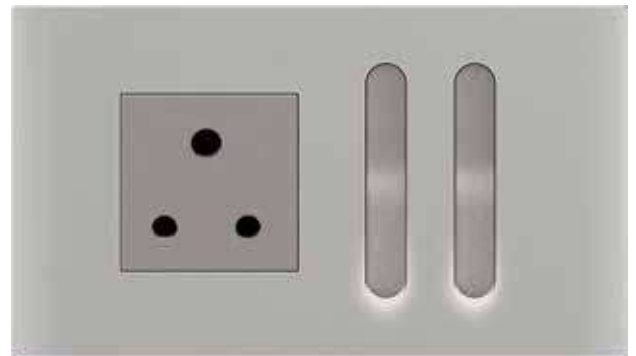

Switches in Elite design are easy to combine with socket outlets, dimmers, or USB chargers. Maximum flexibility for a wealth of combinations and a perfect look even when space is limited.

Pioneering a Sustainable Future with Bio-plastic Innovation



Innovation at Legrand goes beyond the product. Arteor Advance is our first range to feature packaging made with an innovative bio-plastic material. This pioneering eco-packaging solution is 90% biobased and is designed to lower carbon emissions by up to 70%. A conscious step towards a greener product lifecycle and a better future.

ARTEOR™ ADVANCE

FEEL SOMETHING NEW

Live As You Want

Everyone has their own ideas about how to arrange their living space, and people's individual preferences regarding the functionality of electrical equipment will vary widely too. With Arteor Advance, everyone can arrange their own private space accordingly and accommodate as much comfort or energy saving as they want. All in a premium consistent design.





Exploiting Every Potential

The new generation of LED dimmers and LED automatic switches are fully LED compatible and can also be used for all other types of modern loads. This makes it possible to exploit the full energy saving potential of LEDs, without losing out on convenience.



Switch with indicator

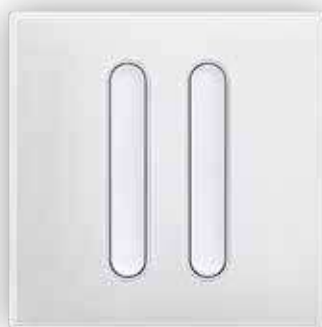

Smart 2-gang wireless batteryless light switch



Rotary fan controller



Double switch for electric shutter



USB Type C+C 30W PD Charger

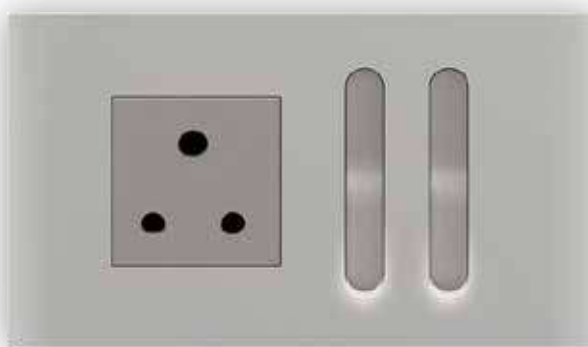

6A - 3 pin ISI Socket with 10A Elite Switch with Locator

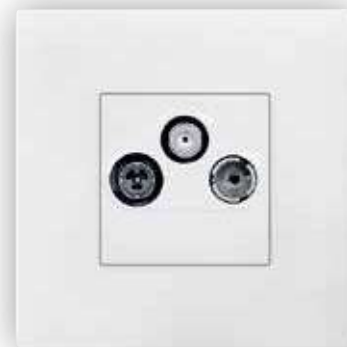

TV-R-SAT sockets

Intelligent & Powerful: The New Usb Chargers

Arteor Advance meets the current USB-C standard with new chargers that integrate harmoniously into the design of the rest of the electrical installation. In addition to their design, they also impress with their performance; they are powerful enough to charge laptops. They also enable "fast charging" and protect the batteries of the connected devices with Power Delivery as they only supply as much power as is needed for charging. Available in 20W, 30W, 45W and 65W.

ARTEOR™ ADVANCE

FEEL SOMETHING NEW

Working with Arteor™ Advance

The boundaries between life and work are becoming increasingly blurred. That's why Arteor Advance offers solutions that make life and work both easier and more comfortable, while making optimal use of the possibilities offered by connectivity. The understated design improves both quality of life and productivity.

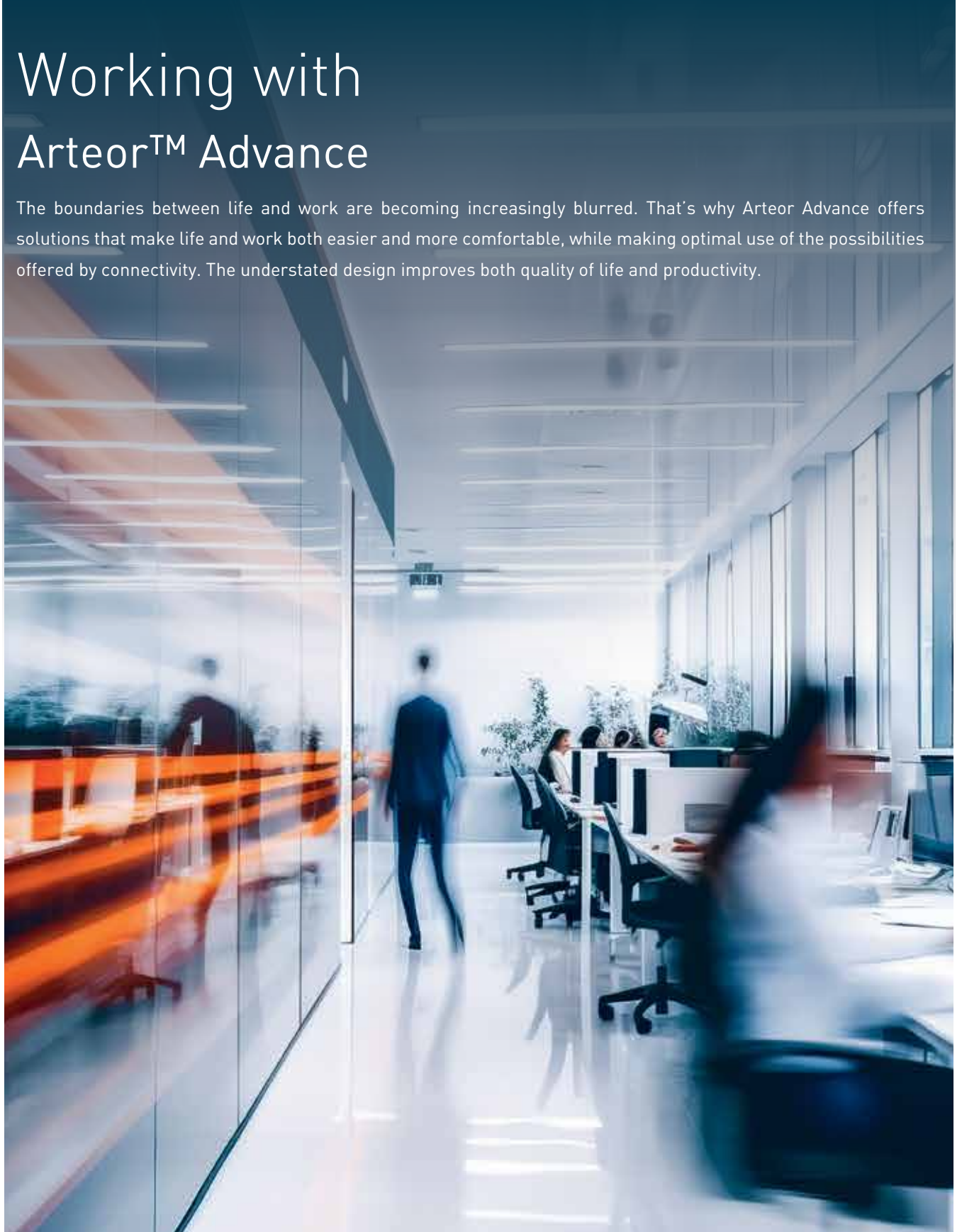



Arteor Advance mechanisms can be incorporated into Pop-Up boxes or Desk devices of the Incara range: seamless integration into furniture - power and data within easy reach.



All-in-one consistent design:

Power supply for all devices, data outlets and USB chargers with enough power for charging a laptop.



LED compatible motion sensors help to save energy as they only switch lights on when needed.

Contactless Switching

A new switch offers a more hygienic way of using lights and doors. It controls lights or opens doors without direct contact. Just position your hand close by, and the desired action will be triggered. In offices, hotels and anywhere lots of people use switches, the contactless switch is a valuable and convenient alternative to traditional solutions.

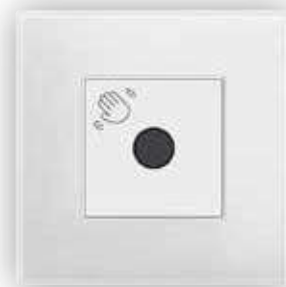

Contactless switch for control of lights or doors.

ARTEOR™
ADVANCE
FEEL SOMETHING NEW

Welcome to the
Arteor™ Advance Hotel

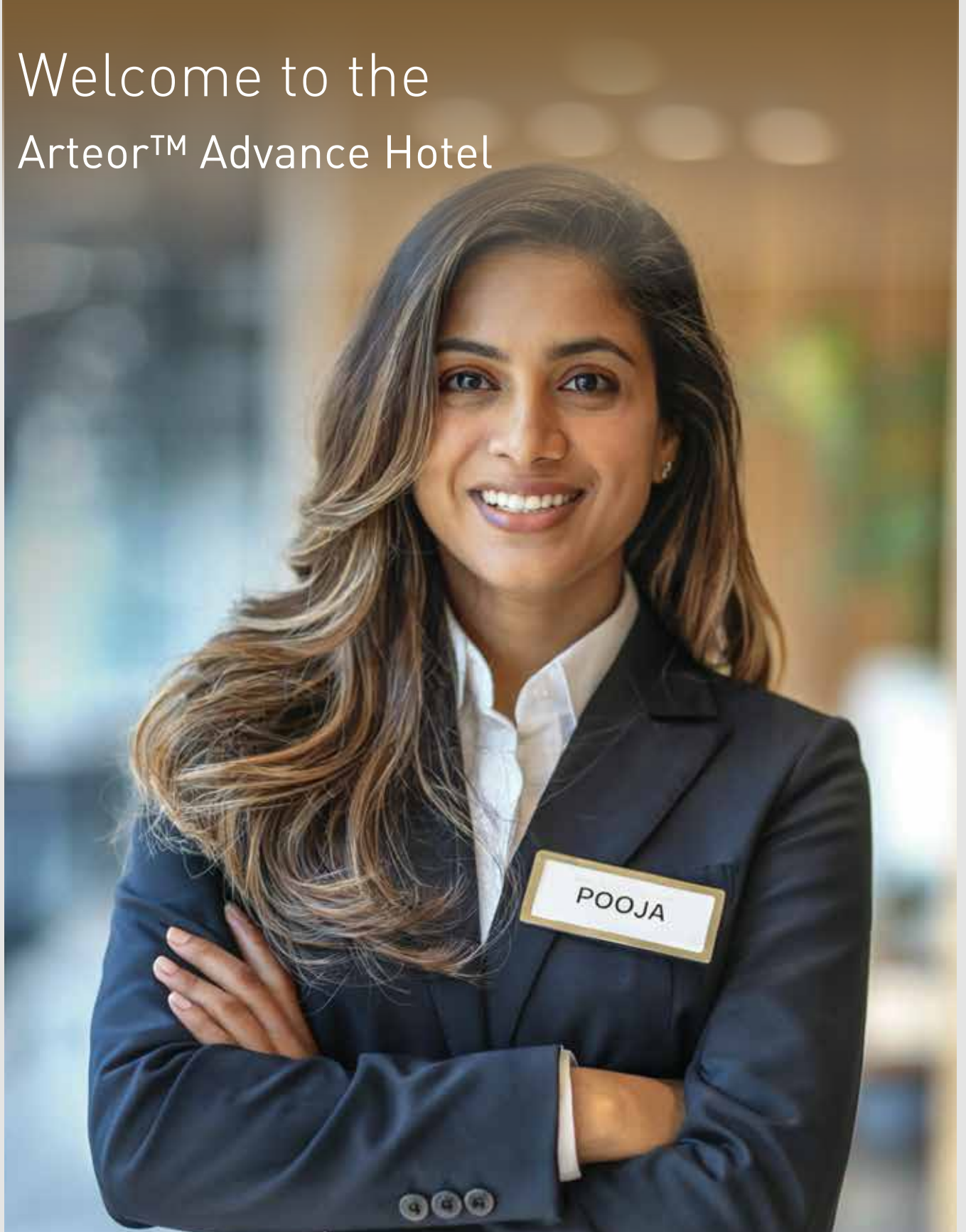



Key-Card Switch



Hotel room call indicator External unit: displays calls in the corridor.



Bedside panel: Dedicated markings allow for easy identification of the different functions: Master ON/OFF, control of bedlights, curtains, roller blinds, and more.



Internal unit: allows to select the desired setting "Do not disturb/ Make up room".

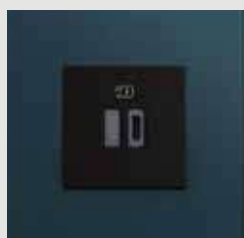

USB Type C 45W PD Charger



Double USB Type-C charger, 65 W, Fast charge feature: Power Delivery

















Shaver Socket

Lots of power with gentle fast charging

USB chargers are an essential feature, and not just for mobile working. They provide enough energy to charge laptops and other devices. The batteries are charged in a particularly resource-efficient manner by intelligently adjusting the charging current to the needs of the devices connected.

Arteor Advance™















NEW! Classic Matt White Mechanisms

Cat.Nos	Description	MRP* ₹ / Unit	Pack
Switches – 10A - 230V AC			
 AC21104MW	10A - Switch - 1 Way - 1 Module	264	1/20/200
 AC21106MW	10A - Switch - 1 Way - with Indicator - 1 Module	488	1/20/200
 AC21105MW	10A - Switch - 1 Way - with Locator - 1 Module	488	1/20/200
 AC21102MW	10A - Switch - 1 Way - with Locator (Blue) - 1 Module	488	1/20/200
 AC22105MW	10A - Switch - 2 Way - 1 Module	432	1/20/200
 AC22107MW	10A - Switch - 2 Way - with Indicator - 1 Module	608	1/20/200
 AC21119MW	10A - Switch - 1 Way - with Indicator - 2 Module	590	1/10/100
Switches – 16A - 230V AC			
 AC21101MW	16A - Switch - 1 Way - 1 Module	442	1/20/200
 AC21118MW	16A - Switch - 1 Way - with Indicator - 1 Module	562	1/20/200
 AC22101MW	16A - Switch - 2 Way - 1 Module	690	1/20/200
 AC22102MW	16A - Switch - 2 Way - with Indicator - 1 Module	700	1/20/200
 AC21103MW	16A - Switch - 1 Way - 2 Module	590	1/10/100
 AC20109MW	16A - Intermediate Switch - 230V AC - 2 Module	3444	1/10/100
 AC22109MW	16A - Switch - 2 Way - 2 Module	970	1/10/100
Switches – 20A - 230V AC			
 AC21107MW	20A - Switch - 1 Way - 1 Module	586	1/20/200
AC21108MW	20A - Switch - 1 Way - with Indicator - 1 Module	664	1/20/200
AC22106MW	20A - Switch - 2 Way - 1 Module	760	1/20/200
AC22108MW	20A - Switch - 2 Way - with Indicator - 1 Module	846	1/20/200
AC21112MW	20A - Switch - 1 Way - 2 Module	698	1/10/100
AC22119MW	20A - Switch - 2 Way - 2 Module	828	1/10/100

* MRP - Maximum Retail Price Inclusive of all taxes including GST.
Red Cat. Nos - New Products

Arteor Advance™

NEW! Classic Matt White Mechanisms

Cat.Nos	Description	MRP* ₹ / Unit	Pack
Switches – 20A - 230V AC			
 AC22113MW	20A - Switch - 2 Way - with Indicator - 2 Module	918	1/10/100
 AC21312MW	20A - Switch - 3 Gang - 1 Way - 2 Module	1652	1/10/100
 AC29101MW	20A - Switch - 3 Gang - 2X2 Way + 1X1 Way - 2 Module	1810	1/10/100
 AC21113MW	20A - Switch - DP - 1 Way - with Indicator - 2 Module	1302	1/10/100
 AC20105MW	20A - Switch - DP - 1 Way - with Indicator & Water Heater Marking - 2 Module	1364	1/10/100
Switches – 25A - 230V AC			
 AC21115MW	25A - Switch - 1 Way - with Indicator - 1 Module	786	1/20/200
Switches – 32A - 230V AC			
 AC20101MW	32A - Switch - DP - 1 Way - with Indicator - 2 Module	1858	1/10/100
Push Button – 10A - 230V AC			
 AC23102MW	10A - Bell Push - 1 Way - 1 Module	484	1/20/200
 AC23103MW	10A - Bell Push - 1 Way - with Locator - 1 Module	642	1/20/200
 AC23104MW	10A - Bell Push - 1 Way - with Locator (Blue) - 1 Module	642	1/20/200
 AC23111MW	10A - Bell Push - 1 Way - 2 Module	682	1/10/100
 AC23112MW	10A - Bell Push - 1 Way - with Locator - 2 Module	914	1/10/100
 AC23121MW	10A - Bell Push - 1 Way - with Locator (Blue) - 2 Module	914	1/10/100
 AC23106MW	10A - Push Button - 1 Way - 1 Module	512	1/20/200
 AC23107MW	10A - Push Button - 1 Way - with Locator - 1 Module	648	1/20/200
AC23120MW	10A - Push Button - 1 Way - with Locator (Blue) - 1 Module	648	1/20/200
AC23108MW	10A - Push Button - 2 Way - 1 Module	714	1/10/100

Bold Cat.Nos are products normally available with Legrand (India) Stockists. Cat.Nos that are not bold - delivery within 4 - 8 weeks from the date of order. Bold packing quantity is our mandatory packing. Orders to be placed by Legrand (India) Stockist in multiples of the same.

Arteor Advance™

NEW! Classic Matt White Mechanisms

Cat.Nos	Description	MRP* ₹ / Unit	Pack
Accessories for Classic and Elite Switches with Locator and Indicator			
A180	Red LED for Indicator 230 V	108	10/100
A186	Blue LED for Locator 230 V	108	10/100
A187	Warm white LED for Locator 230 V 0.8	108	10/100
A188	Warm white LED for Locator 230 V 0.3	108	10/100



Electric Roller Blinds

AC26104MW	Double Switch for Electric Shutter - 2 Module	1184	1/10/100
------------------	---	------	----------

Dimmers and Fan Regulators

AC24103MW	Light Dimmer - 60 to 400 Watts - 2 Module	1996	1/10/100
AC24105MW	Push Dimmer 0-10V - 2 Module	12810	1/20
AC24101MW	Push Dimmer 150W With Neutral - 1 Module	18302	1/5/20
AC24104MW	Push Dimmer 125W Without Neutral - 2 Module	11896	1/20
AC24106MW	Touch Dimmer 5-300W/75W - 2 Module	10980	1/20
AC24107MW	Rotary Dimmer 200W LED - 2 Module	20132	1/10
AC661MW	Fan Step Regulator - 100 Watts - ISI - 1 Module	1604	1/5/50
AC662MW	Fan Step Regulator - 100 Watts - ISI - 2 Module	1980	1/10/100
AC665MW	Fan Step Regulator - 70 Watts - ISI - 2 Module	2110	1/10/100
AC663MW	Fan Step Regulator - 120 Watts - ISI - 2 Module	2118	1/10/100
AC664MW	Fan Regulator - 8 Steps - 100 Watts - ISI - 2 Module	1886	1/10/100



AC664MW

Arteor Advance™

NEW! Classic Matt White Mechanisms

Cat.Nos	Description	MRP* ₹ / Unit	Pack
---------	-------------	------------------	------

Indian Standard Sockets

AC3163MW	6A - Socket - with Shutter - 3 Pin - ISI - 2 Module	404	1/20/200
AC3166MW	6/16A - Socket - with Shutter - 3 Pin - Indian - ISI - 2 Module	818	1/10/100
AC3167MW	6/16A - Socket - with Shutter - 3 Pin - Indian - ISI - 3 Module	980	1/5/50



AC100MW

Energy Plugs

AC100MW	6A - Plug	192	10/100
AC101MW	16A - Plug	256	10/100

USB Chargers

AC3408MW	USB Charger - 3000mA/15 Watts - Type A - 1 Module	3668	1/10/150
AC3410MW	USB Charger - 3000mA/15 Watts - Type A + A - 1 Module	4150	1/10/150
AC3411MW	USB Charger - 3000mA/15 Watts - Type A + C - 1 Module	4626	1/10/150
AC3412MW	USB Charger - 3000mA/15 Watts - Type C + C - 1 Module	5178	1/10/150
AC3409MW	USB Charger - Power Delivery - 20 Watts - Type C - 1 Module	7090	1/10/150
AC3406MW	USB Charger - Power Delivery - 30 Watts - Type C + C - 2 Module	10610	1/20
AC3401MW	USB Charger - Power Delivery - 45 Watts - Type C - 2 Module	13690	1/20
AC3415MW	USB Charger - Power Delivery - 65 Watts - Type C + C - 3 Module	16766	1/20



AC3401MW

Data and Voice

AC423MW	Telephone Socket - Double RJ11 - 1 Module	746	1/20/200
AC424MW	Telephone Socket - RJ11 - with Shutter - 1 Module	434	1/20/200
AC4306MW	Information Socket - RJ45 - Cat 6A - UTP - 1 Module	1946	10/100
AC4315MW	Information Socket - RJ45 Rear Pluggable - CAT6 - UTP - 2 Module	5356	1/10/100



AC4306MW



AC4110MW

TV Sockets

AC4110MW	TV Co - axial Socket - 1 Module	446	1/20/200
-----------------	---------------------------------	-----	----------

* MRP - Maximum Retail Price Inclusive of all taxes including GST.
Red Cat. Nos - New Products

Bold Cat.Nos are products normally available with Legrand (India) Stockists. Cat.Nos that are not bold - delivery within 4 - 8 weeks from the date of order. Bold packing quantity is our mandatory packing. Orders to be placed by Legrand (India) Stockist in multiples of the same.

Arteor Advance™

NEW! Classic Matt White Mechanisms

Cat.Nos	Description	MRP* ₹ / Unit	Pack
---------	-------------	------------------	------

Electronic Chime

AC618MW	Bell Ding Dong - 230V - 2 Module	800	1/10/100
----------------	----------------------------------	-----	----------

Buzzer

AC615MW	Buzzer - 230V - 1 Module	2114	10/60
----------------	--------------------------	------	-------

Bell Call Indicator

AC23105MW	Bell Call Indicator - 1 Module	3070	1/20/200
------------------	--------------------------------	------	----------

Infrared Sensors

AC25102MW	IR Motion Sensor with Neutral - 2 Module	12920	1/20
------------------	--	-------	------

Innovative Switch

AC28102MW	Contactless Door Switch - 12-24-48 V - 2 Module	7466	1/20
AC28101MW	Contactless Light Switch - 230V AC - 2 Module	6718	1/20

Skirting Light

AC653MW	Skirting Light - with LED - 230V - 3 Module	1648	10/100
AC652	Removable Plug-in Skirting Light - 230V - 2 Module	25012	1/12

Lighting

AC654	Over Door Light Unit White/Red/Green/Blue - 2 Module	762	1/50
AC655	Indicator Unit - with transparent & Colored Labels- 1 Module	1234	10/100
AC656	Illuminated Light unit with 4 LED colours (white/red/green/blue) - 2 Module	1360	5/50

Hospitality Function

Hotel "DND and MMR" functions

AC27107MW	Interlocked Internal DND & MMR Control Unit - 2 Module	2364	1/10/100
AC27108MW	External DND & MMR Control Unit - with Bell Push - 2 Module	3298	1/5/50

Hotel Keycard Switch

AC27110MW	16A - Key Card Switch - 230V - 2 Module	9000	1/20
AC27111MW	16A - Key Card Switch with RFID - 230V - 2 Module	9388	1/20
679255	Key Fob for Key Card Switch White	234	-

Arteor Advance™

NEW! Hospitality Funtion

Cat.Nos	Description	MRP* ₹ / Unit	Pack
---------	-------------	------------------	------

Hotel Keycard Switch

076711	Key Fob for RFID Key Card Switch	2698	10/200
---------------	----------------------------------	------	--------

Shaver Socket

AC361MW	Shaver Socket - 230V/120 - 230V - with Earth Connector	9354	1/10
----------------	--	------	------

Time Switch

AC20110MW	Time Delay Switch - 2 Module	11044	1/20
------------------	------------------------------	-------	------

Master Switch

AC22114MW	20A - Master Switch - DP - 2 Way - ON/OFF - 2 Module	812	1/10/100
AC23115MW	Master Push ON/OFF - 2 Way - 2 Module	794	1/10/100

Bedlight Switch

AC21117MW	10A - Bedlight Switch - 2 Way - 2X1 - 2 Module	778	1/5/50
AC23119MW	10A - Push for Bedlight - 2 Way - 2X1 - 2 Module	778	1/5/50

Reading Light

AC657MW	Reading Light LED - 2 Module	4188	1/12
----------------	------------------------------	------	------

Protectors & Accessories

Cat.Nos	Description	MRP* ₹ / Unit	Pack
---------	-------------	------------------	------

Surge Protector

AC627MW	Surge Protector - 1 Module	6692	20/200
----------------	----------------------------	------	--------

Motor Starter

AC20111MW	16A - Motor Starter - 2 Module	1332	1/10/100
AC20112MW	25A - Motor Starter - 2 Module	1368	1/10/100

Modular MCB

AC628MW	16A - SP - Modular MCB - C Curve - 1 Module	796	1/5/50
----------------	---	-----	--------

* MRP - Maximum Retail Price Inclusive of all taxes including GST.
Red Cat. Nos - New Products

Bold Cat.Nos are products normally available with Legrand (India) Stockists. Cat.Nos that are not bold - delivery within 4 - 8 weeks from the date of order. Bold packing quantity is our mandatory packing. Orders to be placed by Legrand (India) Stockist in multiples of the same.

Arteor Advance™

NEW!

Protectors & Accessories

Cat.Nos	Description	MRP* ₹ / Unit	Pack
Modular MCB			
AC625MW	20A - SP - Modular MCB - C Curve - 1 Module	796	1/5/50
AC626MW	32A - SP - Modular MCB - C Curve - 1 Module	796	1/5/50



AC626MW

Audio-Video Sockets

AC4430MW	Female 3.5mm Jack - 1 Module	6684	1/10
AC4421MW	Preterminated Sockets Female Hd15 - 1 Module	9306	1/10
AC4411MW	Preterminated HDMI Socket - 1.4 - 1 Module	11044	1/10
AC4400MW	Loudspeaker Socket - 1 Module	1180	1/10/100
AC4452MW	Male XLR Jack - 2 Module	9484	1/20
AC4412MW	Preterminated HDMI Socket - 1.4 - 2 Module	11598	1/10
AC4106MW	TV-R-SAT Socket - 2 Module	5706	1/0/10
AC4442MW	Triple RCA Socket (Audio & Video) - 1 Module	6022	1/20
AC4362MW	Preterminated USB Data Socket - 1 Module	8322	1/10
AC4360MW	USB Socket - 1 Module	5268	2/0/20
AC4470MW	Line Dying Down - 100V (25 - 30W) - 2 Module	17522	1/20
AC4450MW	Female XLR Jack - 2 Module	10516	1/20
AC4440MW	2 Female RCA Socket - 1 Module	4888	1/10



AC4430MW



AC4411MW



AC4400MW



AC4452MW



AC4362MW



AC4470MW



AC4450MW

Arteor Advance™

NEW!

Protectors & Accessories

Cat.Nos	Description	MRP* ₹ / Unit	Pack
Cable Outlet			
AC350MW	20A - Cable Outlet - 2 Module	1810	10/100
AC354MW	Cord Outlet - with 8mm Diameter - 1 Module	576	20/200



AC350MW

Blanking Plate

AC150MW	Blanking Plate - 1 Module	82	1/40/400
AC153MW	Blanking Plate - 2 Module	122	1/10/100



AC153MW

Mounting Accessories for Panel

A1401	Panel Mounting Support - 2 Module	500	10/100
--------------	-----------------------------------	-----	--------



A1401

Classic - Matt Black Mechanisms

Cat.Nos	Description	MRP* ₹ / Unit	Pack
Switches - 10A - 230V AC			
AC21104MB	10A - Switch - 1 Way - 1 Module	306	1/20/200
AC21106MB	10A - Switch - 1 Way - with Indicator - 1 Module	558	1/20/200
AC21105MB	10A - Switch - 1 Way - with Locator - 1 Module	558	1/20/200
AC22105MB	10A - Switch - 2 Way - 1 Module	500	1/20/200
AC22107MB	10A - Switch - 2 Way - with Indicator - 1 Module	714	1/20/200
AC21119MB	10A - Switch - 1 Way - with Indicator - 2 Module	632	1/10/100



AC21104MB



AC22105MB



AC21119MB

Switches - 16A - 230V AC

AC21101MB	16A - Switch - 1 Way - 1 Module	512	1/20/200
AC21118MB	16A - Switch - 1 Way - with Indicator - 1 Module	640	1/20/200
AC22101MB	16A - Switch - 2 Way - 1 Module	800	1/20/200
AC22102MB	16A - Switch - 2 Way - with Indicator - 1 Module	818	1/20/200
AC21103MB	16A - Switch - 1 Way - 2 Module	632	1/10/100
AC20109MB	16A - Intermediate Switch - 230V AC - 2 Module	3970	10/100
AC22109MB	16A - Switch - 2 Way - 2 Module	1036	1/10/100



AC21101MB



AC22102MB



AC22109MB

* MRP - Maximum Retail Price Inclusive of all taxes including GST.
Red Cat. Nos - New Products

Bold Cat.Nos are products normally available with Legrand (India) Stockists. Cat.Nos that are not bold - delivery within 4 - 8 weeks from the date of order. Bold packing quantity is our mandatory packing. Orders to be placed by Legrand (India) Stockist in multiples of the same.

Arteor Advance™

NEW! Classic - Matt Black Mechanisms

Cat.Nos	Description	MRP* ₹ / Unit	Pack
Switches – 20A - 230V AC			
AC21107MB	20A - Switch - 1 Way - 1 Module	664	1/20/200
AC21108MB	20A - Switch - 1 Way - with Indicator - 1 Module	768	1/20/200
AC22106MB	20A - Switch - 2 Way - 1 Module	862	1/20/200
AC22108MB	20A - Switch - 2 Way - with Indicator - 1 Module	958	1/20/200
AC21112MB	20A - Switch - 1 Way - 2 Module	784	1/10/100
AC22119MB	20A - Switch - 2 Way - 2 Module	924	1/10/100
AC22113MB	20A - Switch - SP - 2 Way - with Indicator - 2 Module	1030	1/10/100
AC21312MB	20A - Switch - 3 Gang - 1 Way - 2 Module	1894	1/10/100
AC29101MB	20A - Switch - 3 Gang - 2X2 Way + 1X1 Way - 2 Module	1984	1/10/100
AC21113MB	20A - Switch - DP - 1 Way - with Indicator - 2 Module	1534	1/10/100
AC20105MB	20A - Switch - DP - 1 Way - with Indicator & Water Heater Marking - 2 Module	1640	1/10/100

Switches – 25A - 230V AC

AC21115MB	25A - Switch - 1 Way - with Indicator - 1 Module	880	1/20/200
------------------	--	-----	----------

Switches – 32A - 230V AC

AC20101MB	32A - Switch - DP - 1 Way - with Indicator - 2 Module	2140	1/10/100
------------------	---	------	----------

Push Button – 10A - 230V AC

AC23102MB	10A - Bell Push - 1 Way - 1 Module	544	1/20/200
AC23103MB	10A - Bell Push - 1 Way - with Locator - 1 Module	752	1/20/200

Arteor Advance™

NEW! Classic - Matt Black Mechanisms

Cat.Nos	Description	MRP* ₹ / Unit	Pack
Push Button – 10A - 230V AC			
AC23111MB	10A - Bell Push - 1 Way - 2 Module	778	1/10/100
AC23112MB	10A - Bell Push - 1 Way - with Locator - 2 Module	1048	1/10/100
AC23106MB	10A - Push Button - 1 Way - 1 Module	566	1/20/200
AC23107MB	10A - Push Button - 1 Way - with Locator - 1 Module	754	1/20/200
AC23108MB	10A - Push Button - 2 Way - 1 Module	830	1/5/50

Electric Roller Blinds

AC26104MB	Double Switch for Electric Shutter - 2 Module	1376	1/10/100
------------------	---	------	----------

Dimmers and Fan Regulators

AC24103MB	Light Dimmer - 60 to 400 Watts - 2 Module	2304	1/10/100
AC24105MB	Push Dimmer 0-10V - 2 Module	13324	1/20
AC24101MB	Push Dimmer 150W With Neutral - 1 Module	19032	1/5/20
AC24104MB	Push Dimmer 125W Without Neutral - 2 Module	12372	1/20
AC24106MB	Touch Dimmer 5-300W/75W - 2 Module	11882	1/20
AC24107MB	Rotary Dimmer 200W LED - 2 Module	21782	1/10
AC661MB	Fan Step Regulator - 100 Watts - ISI - 1 Module	1848	1/5/50
AC662MB	Fan Step Regulator - 100 Watts - ISI - 2 Module	2280	1/10/100
AC665MB	Fan Step Regulator - 70 Watts - ISI - 2 Module	2420	1/10/100
AC663MB	Fan Step Regulator - 120 Watts - ISI - 2 Module	2440	1/10/100
AC664MB	Fan Regulator - 8 Step - 100 Watts - ISI - 2 Module	2164	1/10/100

* MRP - Maximum Retail Price Inclusive of all taxes including GST.
Red Cat. Nos - New Products

Bold Cat.Nos are products normally available with Legrand (India) Stockists. Cat.Nos that are not bold - delivery within 4 - 8 weeks from the date of order. Bold packing quantity is our mandatory packing. Orders to be placed by Legrand (India) Stockist in multiples of the same.

Arteor Advance™

NEW! Classic - Matt Black Mechanisms

Cat.Nos	Description	MRP* ₹ / Unit	Pack
Indian Standard Sockets			
AC3163MB	6A - Socket - with Shutter - 3 Pin - ISI - 2 Module	472	1/20/200
AC3166MB	6/16A - Socket - with Shutter - 3 Pin - Indian - ISI - 2 Module	922	1/10/100
AC3167MB	6/16A - Socket - with Shutter - 3 Pin - Indian - ISI - 3 Module	1122	1/5/50

USB Chargers

AC3408MB	USB Charger - 3000mA/15 Watts - Type A - 1 Module	4042	1/10/150
AC3410MB	USB Charger - 3000mA/15 Watts - Type A + A - 1 Module	4610	1/10/150
AC3411MB	USB Charger - 3000mA/15 Watts - Type A + C - 1 Module	5288	1/10/150
AC3412MB	USB Charger - 3000mA/15 Watts - Type C + C - 1 Module	5778	1/10/150
AC3409MB	USB Charger - Power Delivery - 20 Watts - Type C - 1 Module	7596	1/10/150
AC3406MB	USB Charger - Power Delivery - 30 Watts - Type C + C - 2 Module	11096	1/20
AC3401MB	USB Charger - Power Delivery - 45 Watts - Type C - 2 Module	14322	1/20
AC3415MB	USB Charger - Power Delivery - 65 Watts - Type C + C - 3 Module	17542	1/20

Data and Voice

AC423MB	Telephone Socket - Double RJ11 - 1 Module	860	1/20/200
AC424MB	Telephone Socket - RJ11 - with Shutter - 1 Module	520	1/20/200
AC4306MB	Information Socket - RJ45 - Cat 6A - UTP - 1 Module	2346	10/100
AC4315MB	Information Socket - RJ45 Rear Pluggable - CAT6 - UTP - 2 Module	5824	1/10/100

TV Sockets

AC4110MB	TV Co - axial Socket - 1 Module	524	1/20/200
-----------------	---------------------------------	-----	----------

Arteor Advance™

NEW! Classic - Matt Black Mechanisms

Cat.Nos	Description	MRP* ₹ / Unit	Pack
---------	-------------	------------------	------

Electronic Chime

AC618MB	Bell Ding Dong - 230V - 2 Module	856	1/10/100
----------------	----------------------------------	-----	----------

Buzzer

AC615MB	Buzzer - 230V - 1 Module	2318	10/60
----------------	--------------------------	------	-------

Bell Call Indicator

AC23105MB	Bell Call Indicator - 1 Module	3534	1/20/200
------------------	--------------------------------	------	----------

Infrared Sensors

AC25102MB	IR Motion Sensor with Neutral - 2 Module	14862	1/20
------------------	--	-------	------

Innovative Switch

AC28102MB	Contactless Door Switch - 12-24-48 V - 2 Module	8586	1/20
AC28101MB	Contactless Light Switch - 230V AC - 2 Module	7728	1/20

Skirting Light

AC653MB	Skirting Light - with LED - 230V - 3 Module	1900	10/100
----------------	---	------	--------

Protectors & Accessories

Cat.Nos	Description	MRP* ₹ / Unit	Pack
---------	-------------	------------------	------

Hotel "DND and MMR" functions

AC27107MB	Interlocked Internal DND & MMR Control Unit - 2 Module	2734	1/10/100
AC27108MB	External DND & MMR Control Unit - with Bell Push - 2 Module	3778	1/5/50

Hotel Keycard Switch

AC27110MB	16A - Key Card Switch - 230V - 2 Module	9908	1/20
AC27111MB	16A - Key Card Switch with RFID - 230V - 2 Module	10336	1/20

Shaver Socket

AC361MB	Shaver Socket - 230V/120 - 230V - with Earth Connector	10302	1/10
----------------	--	-------	------

Time Switch

AC20110MB	Time Delay Switch - 2 Module	12220	1/20
------------------	------------------------------	-------	------

* MRP - Maximum Retail Price Inclusive of all taxes including GST.
Red Cat. Nos - New Products

Bold Cat.Nos are products normally available with Legrand (India) Stockists. Cat.Nos that are not bold - delivery within 4 - 8 weeks from the date of order. Bold packing quantity is our mandatory packing. Orders to be placed by Legrand (India) Stockist in multiples of the same.

Arteor Advance™

NEW! Hospitality Function

Cat.Nos	Description	MRP* ₹ / Unit	Pack
---------	-------------	------------------	------

Master Switch

AC22114MB	20A - Master Switch - DP - 2 Way - ON/OFF - 2 Module	948	1/10/100
AC23115MB	Master Push ON/OFF - 2 Way - 2 Module	908	1/10/100



AC22114MB

Bedlight Switch

AC21117MB	10A - Bedlight Switch - 2 Way - 2X1 - 2 Module	908	1/5/50
AC23119MB	10A - Push for Bedlight - 2 Way - 2X1 - 2 Module	908	1/5/50



AC657MB

Reading Light

AC657MB	Reading Light LED - 2 Module	4348	1/12
----------------	------------------------------	------	------

Protectors & Accessories

Surge Protector

AC627MB	Surge Protector - 1 Module	7364	20/200
----------------	----------------------------	------	--------



AC627MB

Motor Starter

AC20111MB	16A - Motor Starter - 2 Module	1566	1/10/100
AC20112MB	25A - Motor Starter - 2 Module	1604	1/10/100



AC20112MB

Modular MCB

AC628MB	16A - SP - Modular MCB - C Curve - 1 Module	916	1/5/50
AC625MB	20A - SP - Modular MCB - C Curve - 1 Module	916	1/5/50
AC626MB	32A - SP - Modular MCB - C Curve - 1 Module	916	1/5/50



AC628MB



AC626MB

Audio-Video Sockets

AC4430MB	Female 3.5mm Jack - 1 Module	7424	1/10
AC4421MB	Preterminated Sockets Female Hd15 - 1 Module	10240	1/10
AC4411MB	Preterminated HDMI Socket - 1.4 - 1 Module	11604	1/10
AC4400MB	Loudspeaker Socket - 1 Module	1300	1/10/100
AC4452MB	Male XLR Jack - 2 Module	10954	1/20
AC4412MB	Preterminated HDMI Socket - 1.4 - 2 Module	12188	1/10
AC4106MB	TV-R-SAT Socket - 2 Module	6582	1/0/10



AC4430MB



AC4411MB



AC4400MB



AC4106MB

Arteor Advance™

NEW! Protectors & Accessories

Cat.Nos	Description	MRP* ₹ / Unit	Pack
---------	-------------	------------------	------

Audio-Video Sockets

AC4442MB	Triple RCA Socket (Audio & Video) - 1 Module	6526	1/20
AC4362MB	Preterminated USB Data Socket - 1 Module	8754	1/10
AC4360MB	USB Socket - 1 Module	5882	2/0/20
AC4470MB	Line Dying Down - 100V (25 - 30W) - 2 Module	20912	1/20
AC4450MB	Female XLR Jack - 2 Module	13178	1/20
AC4440MB	2 Female RCA Socket - 1 Module	5318	1/10



AC4362MB



AC4360MB



AC4470MB

Cable Outlet

AC354MB	Cord Outlet - with 8mm Diameter - 1 Module	638	20/200
----------------	--	-----	--------



AC354MB

Blanking Plate

AC150MB	Blanking Plate - 1 Module	80	1/40/400
AC153MB	Blanking Plate - 2 Module	138	1/10/100



AC153MB

Classic - Matt Titanium Mechanisms

Switches - 10A - 230V AC

AC21104MT	10A - Switch - 1 Way - 1 Module	306	1/20/200
AC21106MT	10A - Switch - 1 Way - with Indicator - 1 Module	558	1/20/200
AC21105MT	10A - Switch - 1 Way - with Locator - 1 Module	558	1/20/200
AC22105MT	10A - Switch - 2 Way - 1 Module	500	1/20/200
AC22107MT	10A - Switch - 2 Way - with Indicator - 1 Module	714	1/20/200
AC21119MT	10A - Switch - 1 Way - with Indicator - 2 Module	632	1/10/100



AC21104MT



AC22105MT



AC21119MT

* MRP - Maximum Retail Price Inclusive of all taxes including GST.
Red Cat. Nos - New Products

Bold Cat.Nos are products normally available with Legrand (India) Stockists. Cat.Nos that are not bold - delivery within 4 - 8 weeks from the date of order. Bold packing quantity is our mandatory packing. Orders to be placed by Legrand (India) Stockist in multiples of the same.

Arteor Advance™

NEW!

Classic - Matt Titanium Mechanisms

Cat.Nos	Description	MRP* ₹ / Unit	Pack
---------	-------------	------------------	------

Switches – 16A - 230V AC

AC21101MT	16A - Switch - 1 Way - 1 Module	512	20/200
AC21118MT	16A - Switch - 1 Way - with Indicator - 1 Module	640	1/20/200
AC222101MT	16A - Switch - 2 Way - 1 Module	800	1/20/200
AC222102MT	16A - Switch - 2 Way - with Indicator - 1 Module	818	1/20/200
AC21103MT	16A - Switch - 1 Way - 2 Module	632	1/10/100
AC20109MT	16A - Intermediate Switch - 230V AC - 2 Module	3970	1/10/100
AC222109MT	16A - Switch - 2 Way - 2 Module	1036	1/10/100

Switches – 20A - 230V AC

AC21107MT	20A - Switch - 1 Way - 1 Module	664	1/20/200
AC21108MT	20A - Switch - 1 Way - with Indicator - 1 Module	768	1/20/200
AC222106MT	20A - Switch - 2 Way - 1 Module	862	1/20/200
AC222108MT	20A - Switch - 2 Way - with Indicator - 1 Module	958	1/20/200
AC21112MT	20A - Switch - 1 Way - 2 Module	784	1/10/100
AC222119MT	20A - Switch - 2 Way - 2 Module	924	1/10/100
AC222113MT	20A - Switch - 2 Way - with Indicator - 2 Module	1030	1/10/100
AC21312MT	20A - Switch - 3 Gang - 1 Way - 2 Module	1894	1/10/100
AC29101MT	20A - Switch - 3 Gang - 2X2 Way + 1X1 Way - 2 Module	1984	1/10/100
AC21113MT	20A - Switch - DP - 1 Way - with Indicator - 2 Module	1534	1/10/100
AC20105MT	20A - Switch - DP - 1 Way - with Indicator & Water Heater Marking - 2 Module	1640	1/10/100

Arteor Advance™

NEW!

Classic - Matt Titanium Mechanisms

Cat.Nos	Description	MRP* ₹ / Unit	Pack
---------	-------------	------------------	------

Switches – 25A - 230V AC

AC21115MT	25A - Switch - 1 Way - with Indicator - 1 Module	880	1/20/200
------------------	--	-----	----------

Switches – 32A - 230V AC

AC20101MT	32A - Switch - DP - 1 Way - with Indicator - 2 Module	2140	1/10/100
------------------	---	------	----------

Push Button – 10A - 230V AC

AC23102MT	10A - Bell Push - 1 Way - 1 Module	544	1/20/200
AC23103MT	10A - Bell Push - 1 Way - with Locator - 1 Module	752	1/20/200
AC23111MT	10A - Bell Push - 1 Way - 2 Module	778	1/10/100
AC23112MT	10A - Bell Push - 1 Way - with Locator - 2 Module	1048	1/10/100
AC23106MT	10A - Push Button - 1 Way - 1 Module	566	1/20/200
AC23107MT	10A - Push Button - 1 Way - with Locator - 1 Module	754	1/20/200
AC23108MT	10A - Push Button - 2 Way - 1 Module	830	1/5/50

Electric Roller Blinds

AC26104MT	Double Switch for Electric Shutter - 2 Module	1432	1/10/100
------------------	---	------	----------

Dimmers and Fan Regulators

AC24103MT	Light Dimmer - 60 to 400 Watts - 2 Module	2304	1/10/100
AC24105MT	Push Dimmer 0-10V - 2 Module	13862	1/20
AC24101MT	Push Dimmer 150W With Neutral - 1 Module	19802	1/5/20
AC24104MT	Push Dimmer 125W Without Neutral - 2 Module	12872	1/20
AC24106MT	Touch Dimmer 5-300W/75W - 2 Module	11882	1/20
AC24107MT	Rotary Dimmer 200W LED - 2 Module	21782	1/10
AC661MT	Fan Step Regulator - 100 Watts - ISI - 1 Module	1848	1/5/50
AC662MT	Fan Step Regulator - 100 Watts - ISI - 2 Module	2280	1/10/100
AC665MT	Fan Step Regulator - 70 Watts - ISI - 2 Module	2420	1/10/100
AC663MT	Fan Step Regulator - 120 Watts - ISI - 2 Module	2440	1/10/100
AC664MT	Fan Regulator - 8 Step - 100 Watts - ISI - 2 Module	2164	1/10/100

* MRP - Maximum Retail Price Inclusive of all taxes including GST.
Red Cat. Nos - New Products

Bold Cat.Nos are products normally available with Legrand (India) Stockists. Cat.Nos that are not bold - delivery within 4 - 8 weeks from the date of order. Bold packing quantity is our mandatory packing. Orders to be placed by Legrand (India) Stockist in multiples of the same.

Arteor Advance™

NEW! Classic - Matt Titanium Mechanisms

Cat.Nos	Description	MRP* ₹ / Unit	Pack
Indian Standard Sockets			
AC3163MT	6A - Socket - with Shutter - 3 Pin - ISI - 2 Module	472	1/20/200
AC3166MT	6/16A - Socket - with Shutter - 3 Pin - Indian - ISI - 2 Module	922	1/10/100
AC3167MT	6/16A - Socket - with Shutter - 3 Pin - Indian - ISI - 3 Module	1122	1/5/50

USB Chargers

AC3408MT	USB Charger - 3000mA/15 Watts - Type A - 1 Module	4042	1/10/150
AC3410MT	USB Charger - 3000mA/15 Watts - Type A + A - 1 Module	4610	1/10/150
AC3411MT	USB Charger - 3000mA/15 Watts - Type A + C - 1 Module	5288	1/10/150
AC3412MT	USB Charger - 3000mA/15 Watts - Type C + C - 1 Module	5778	1/10/150
AC3409MT	USB Charger - Power Delivery - 20 Watts - Type C - 1 Module	7596	1/10/150
AC3406MT	USB Charger - Power Delivery - 30 Watts - Type C + C - 2 Module	11096	1/20
AC3401MT	USB Charger - Power Delivery - 45 Watts - Type C - 2 Module	14322	1/20
AC3415MT	USB Charger - Power Delivery - 65 Watts - Type C + C - 3 Module	17542	1/20

Data and Voice

AC423MT	Telephone Socket - Double RJ11 - 1 Module	860	1/20/200
AC424MT	Telephone Socket - RJ11 - with Shutter - 1 Module	520	1/20/200
AC4306MT	Information Socket - RJ45 - Cat 6A - UTP - 1 Module	2346	10/100
AC4315MT	Information Socket - RJ45 Rear Pluggable - CAT6 - UTP - 2 Module	5824	1/10/100

TV Sockets

AC4110MT	TV Co - axial Socket - 1 Module	524	1/20/200
-----------------	---------------------------------	-----	----------

Arteor Advance™

NEW! Classic - Matt Titanium Mechanisms

Cat.Nos	Description	MRP* ₹ / Unit	Pack
---------	-------------	------------------	------

Electronic Chime

AC618MT	Bell Ding Dong - 230V - 2 Module	856	1/10/100
----------------	----------------------------------	-----	----------

Buzzer

AC615MT	Buzzer - 230V - 1 Module	2318	10/60
----------------	--------------------------	------	-------

Bell Call Indicator

AC23105MT	Bell Call Indicator - 1 Module	3534	1/20/200
------------------	--------------------------------	------	----------

Infrared Sensors

AC25102MT	IR Motion Sensor with Neutral - 2 Module	14862	1/20
------------------	--	-------	------

Innovative Switch

AC28102MT	Contactless Door Switch - 12-24-48 V - 2 Module	8586	1/20
AC28101MT	Contactless Light Switch - 230V AC - 2 Module	7728	1/20

Skirting Light

AC653MT	Skirting Light - with LED - 230V - 3 Module	1900	10/100
----------------	---	------	--------

Hospitality Function

Hotel "DND and MMR" functions

AC27107MT	Interlocked Internal DND & MMR Control Unit - 2 Module	2734	1/10/100
AC27108MT	External DND & MMR Control Unit - with Bell Push - 2 Module	3778	1/5/50

Hotel Keycard Switch

AC27110MT	16A - Key Card Switch - 230V - 2 Module	9908	1/20
AC27111MT	16A - Key Card Switch with RFID - 230V - 2 Module	10336	1/20

Shaver Socket

AC361MT	Shaver Socket - 230V/120 - 230V - with Earth Connector	10302	1/10
----------------	--	-------	------

Time Switch

AC20110MT	Time Delay Switch - 2 Module	12220	1/20
------------------	------------------------------	-------	------

* MRP - Maximum Retail Price Inclusive of all taxes including GST.
Red Cat. Nos - New Products

Bold Cat.Nos are products normally available with Legrand (India) Stockists. Cat.Nos that are not bold - delivery within 4 - 8 weeks from the date of order. Bold packing quantity is our mandatory packing. Orders to be placed by Legrand (India) Stockist in multiples of the same.

Arteor Advance™

NEW!

Hospitality Function

Cat.Nos	Description	MRP* ₹ / Unit	Pack
---------	-------------	------------------	------

Master Switch

AC22114MT	20A - Master Switch - DP - 2 Way - ON/OFF - 2 Module	948	1/10/100
AC23115MT	Master Push ON/OFF - 2 Way - 2 Module	908	1/10/100



AC22114MT

Bedlight Switch

AC21117MT	10A - Bedlight Switch - 2 Way - 2X1 2 Module	908	1/5/50
AC23119MT	10A - Push for Bedlight - 2 Way - 2X1 2 Module	908	1/5/50



AC21117MT

Arteor Advance™

Protectors & Accessories

Surge Protector

AC627MT	Surge Protector - 1 Module	7364	20/200
----------------	----------------------------	------	--------



AC627MT

Motor Starter

AC20111MT	16A - Motor Starter - 2 Module	1566	1/10/100
AC20112MT	25A - Motor Starter - 2 Module	1604	1/10/100



AC20111MT

Modular MCB

AC628MT	16A - SP - Modular MCB - C Curve - 1 Module	916	1/5/50
AC625MT	20A - SP - Modular MCB - C Curve - 1 Module	916	1/5/50
AC626MT	32A - SP - Modular MCB - C Curve - 1 Module	916	1/5/50



AC628MT



AC625MT



AC626MT

Audio-Video Sockets

AC4430MT	Female 3.5mm Jack - 1 Module	7424	1/10
AC4421MT	Preterminated Sockets Female Hd15 - 1 Module	10240	1/10
AC4411MT	Preterminated HDMI Socket - 1.4 - 1 Module	11604	1/10
AC4400MT	Loudspeaker Socket - 1 Module	1300	1/10/100
AC4452MT	Male XLR Jack - 2 Module	10954	1/20



AC4430MT



AC4411MT



AC4400MT

Arteor Advance™

NEW!

Protectors & Accessories

Cat.Nos	Description	MRP* ₹ / Unit	Pack
---------	-------------	------------------	------

Audio-Video Sockets

AC4412MT	Preterminated HDMI Socket - 1.4 - 2 Module	12188	1/10
AC4106MT	TV-R-SAT Socket - 2 Module	6582	1/0/10
AC4442MT	Triple RCA Socket (Audio & Video) - 1 Module	6526	1/20
AC4362MT	Preterminated USB Data Socket - 1 Module	8754	1/10
AC4360MT	USB Socket - 1 Module	5882	2/0/20
AC4470MT	Line Dying Down - 100V (25 - 30W) - 2 Module	21094	1/20
AC4450MT	Female XLR Jack - 2 Module	13178	1/20
AC4440MT	2 Female RCA Socket - 1 Module	5318	1/10



AC4106MT



AC4362MT



AC4360MT



AC4450MT



AC354MT

Cable Outlet

AC354MT	Cord Outlet - with 8mm Diameter - 1 Module	632	20/200
----------------	--	-----	--------

Blanking Plate

AC150MT	Blanking Plate - 1 Module	80	1/40/400
AC153MT	Blanking Plate - 2 Module	138	1/10/100



AC153MT

Elite Matt White Mechanisms

Cat.Nos	Description	MRP* ₹ / Unit	Pack
---------	-------------	------------------	------

Switches - 10A - 230V AC

AA21104MW	10A - Switch - 1 Way - 1 Module	316	1/10/100
AA21106MW	10A - Switch - 1 Way - with Indicator - 1 Module	586	1/10/100
AA21105MW	10A - Switch - 1 Way - with Locator - 1 Module	586	1/10/100
AA21102MW	10A - Switch - 1 Way - with Locator (Blue) - 1 Module	586	1/10/100
AA22105MW	10A - Switch - 2 Way - 1 Module	520	1/10/100
AA22107MW	10A - Switch - 2 Way - with Indicator - 1 Module	732	1/10/100



AA21104MW



AA21102MW



AA22107MW

* MRP - Maximum Retail Price Inclusive of all taxes including GST.
Red Cat. Nos - New Products

Bold Cat.Nos are products normally available with Legrand (India) Stockists. Cat.Nos that are not bold - delivery within 4 - 8 weeks from the date of order. Bold packing quantity is our mandatory packing. Orders to be placed by Legrand (India) Stockist in multiples of the same.

Arteor Advance™

NEW! Elite Matt White Mechanisms

Cat.Nos	Description	MRP* ₹ / Unit	Pack
Switches – 16A - 230V AC			
AA21101MW	16A - Switch - 1 Way - 1 Module	528	1/10/100
AA21120MW	16A - Switch - 1 Way - with Indicator - 1 Module	676	1/10/100
AA22101MW	16A - Switch - 2 Way - 1 Module	828	1/10/100
AA22102MW	16A - Switch - 2 Way - with Indicator - 1 Module	842	1/10/100

Switches – 20A - 230V AC

AA21107MW	20A - Switch - 1 Way - 1 Module	702	1/10/100
AA21108MW	20A - Switch - 1 Way - with Indicator - 1 Module	798	1/10/100
AA22106MW	20A - Switch - 2 Way - 1 Module	914	1/10/100
AA22108MW	20A - Switch - 2 Way - with Indicator - 1 Module	1016	1/10/100

Push Button – 10A - 230V AC

AA23102MW	10A - Bell Push - 1 Way - 1 Module	582	1/10/100
AA23103MW	10A - Bell Push - 1 Way - with Locator - 1 Module	772	1/10/100
AA23104MW	10A - Bell Push - 1 Way - with Locator (Blue) - 1 Module	772	1/10/100
AA23101MW	10A - Push Button - 1 Way - 1 Module	616	1/10/100
AA23108MW	10A - Push Button - 2 Way - 1 Module	856	1/10/100

Electric Roller Blinds

AA26104MW	Double Switch for Electric Shutter - 2 Module	1420	1/5/50
-----------	---	------	--------

Dimmers and Fan Regulators

AA24107MW	Rotary Dimmer 200W LED - 2 Module	24158	1/10
AA667MW	Fan Step Regulator - 70 Watts - ISI - 2 Module	2532	1/3/30
AA664MW	Fan Regulator - 8 Step - 100 Watts - ISI - 2 Module	2264	1/3/30
AA669MW	Fan Step Regulator - 120 Watts - ISI - 2 Module	2540	1/3/30

Temperature Room Control Unit

AA674MW	Temperature Room Control Unit	20502	1/20
---------	-------------------------------	-------	------

USB Chargers

AA3406MW	USB Charger - Power Delivery - 30 Watts - Type C + C - 2 Module	12730	1/20
AA3401MW	USB Charger - Power Delivery - 45 Watts - Type C - 2 Module	16428	1/20

* MRP - Maximum Retail Price Inclusive of all taxes including GST.
Red Cat. Nos - New Products

Arteor Advance™

NEW! Hospitality Function

Cat.Nos	Description	MRP* ₹ / Unit	Pack
Hotel "DND and MMR" functions			
AA27107MW	Interlocked Internal DND & MMR Control Unit - 2 Module	2838	1/5/50
AA27108MW	External DND & MMR Control Unit - with Bell Push - 2 Module	3956	1/5/50

Master Push Button

AA23115MW	Master Push ON/OFF - 2 Way - 1 Module	954	1/10/100
-----------	---------------------------------------	-----	----------

Bedlight Switch

AA21117MW	10A - Bedlight Switch - 2 Way - 2X1 2 Module	934	1/5/50
AA23119MW	10A - Push for Bedlight - 2 Way - 2X1 2 Module	934	1/5/50

Blanking Plate

AA150MW	Blanking Plate - 1 Module	102	1/10/100
---------	---------------------------	-----	----------

Arteor Advance™

Elite Matt Black Mechanisms

Cat.Nos	Description	MRP* ₹ / Unit	Pack
---------	-------------	------------------	------

Switches – 10A - 230V AC

AA21104MB	10A - Switch - 1 Way - 1 Module	368	1/10/100
AA21106MB	10A - Switch - 1 Way - with Indicator - 1 Module	668	1/10/100
AA21105MB	10A - Switch - 1 Way - with Locator - 1 Module	668	1/10/100
AA22105MB	10A - Switch - 2 Way - 1 Module	600	1/10/100
AA22107MB	10A - Switch - 2 Way - with Indicator - 1 Module	856	1/10/100

Switches – 16A - 230V AC

AA21101MB	16A - Switch - 1 Way - 1 Module	616	1/10/100
AA21120MB	16A - Switch - 1 Way - with Indicator - 1 Module	768	1/10/100
AA22101MB	16A - Switch - 2 Way - 1 Module	958	1/10/100
AA22102MB	16A - Switch - 2 Way - with Indicator - 1 Module	984	1/10/100

Switches – 20A - 230V AC

AA21107MB	20A - Switch - 1 Way - 1 Module	798	1/10/100
AA21108MB	20A - Switch - 1 Way - with Indicator - 1 Module	920	1/10/100
AA22106MB	20A - Switch - 2 Way - 1 Module	1034	1/10/100
AA22108MB	20A - Switch - 2 Way - with Indicator - 1 Module	1148	1/10/100

Bold Cat.Nos are products normally available with Legrand (India) Stockists. Cat.Nos that are not bold - delivery within 4 - 8 weeks from the date of order. Bold packing quantity is our mandatory packing. Orders to be placed by Legrand (India) Stockist in multiples of the same.

Arteor Advance™

NEW!

Elite Matt Black Mechanisms

Cat.Nos	Description	MRP* ₹ / Unit	Pack
---------	-------------	------------------	------

Push Button – 10A - 230V AC

AA23102MB	10A - Bell Push - 1 Way - 1 Module	654	1/10/100
AA23103MB	10A - Bell Push - 1 Way - with Locator - 1 Module	902	1/10/100
AA23101MB	10A - Push Button - 1 Way - 1 Module	680	1/10/100
AA23108MB	10A - Push Button - 2 Way - 1 Module	996	1/5/50

Electric Roller Blinds and Curtain Control

AA26104MB	Double Switch for Electric Shutter - 2 Module	1650	1/5/50
------------------	---	------	--------

Dimmers and Fan Regulators

AA24107MB	Rotary Dimmer 200W LED - 2 Module	26138	1/10
AA667MB	Fan Step Regulator - 70 Watts - ISI - 2 Module	2904	1/3/30
AA664MB	Fan Regulator - 8 Step - 100 Watts - ISI - 2 Module	2598	1/3/30
AA669MB	Fan Step Regulator - 120 Watts - ISI - 2 Module	2928	1/3/30

Temperature Room Control Unit

AA674MB	Temperature Room Control Unit	23578	1/20
----------------	-------------------------------	-------	------

USB Chargers

AA3406MB	USB Charger - Power Delivery - 30 Watts - Type C + C - 2 Module	13318	1/20
AA3401MB	USB Charger - Power Delivery - 45 Watts - Type C - 2 Module	17184	1/20

Arteor Advance™

Hospitality Function

Hotel "DND and MMR" functions

AA27107MB	Interlocked Internal DND & MMR Control Unit - 2 Module	3278	1/5/50
AA27108MB	External DND & MMR Control Unit - with Bell Push - 2 Module	4532	1/5/50

Arteor Advance™

NEW!

Hospitality Function

Cat.Nos	Description	MRP* ₹ / Unit	Pack
---------	-------------	------------------	------

Master Push Button

AA23115MB	Master Push ON/OFF - 2 Way - 1 Module	1088	1/10/100
------------------	---------------------------------------	------	----------

Bedlight Switch

AA21117MB	10A - Bedlight Switch - 2 Way - 2X1 2 Module	1088	1/5/50
AA23119MB	10A - Push for Bedlight - 2 Way - 2X1 2 Module	1088	1/5/50

Blanking Plate

AA150MB	Blanking Plate - 1 Module	98	1/10/100
----------------	---------------------------	----	----------

Arteor Advance™

Elite - Matt Titanium Mechanisms

Cat.Nos	Description	MRP* ₹ / Unit	Pack
---------	-------------	------------------	------

Switches – 10A - 230V AC

AA21104MT	10A - Switch - 1 Way - 1 Module	368	1/10/100
AA21106MT	10A - Switch - 1 Way - with Indicator - 1 Module	668	1/10/100
AA21105MT	10A - Switch - 1 Way - with Locator - 1 Module	668	1/10/100
AA22105MT	10A - Switch - 2 Way - 1 Module	600	1/10/100
AA22107MT	10A - Switch - 2 Way - with Indicator - 1 Module	856	1/10/100

Switches – 16A - 230V AC

AA21101MT	16A - Switch - 1 Way - 1 Module	616	1/10/100
AA21120MT	16A - Switch - 1 Way - with Indicator - 1 Module	768	1/10/100
AA22101MT	16A - Switch - 2 Way - 1 Module	958	1/10/100
AA22102MT	16A - Switch - 2 Way - with Indicator - 1 Module	984	1/10/100

Switches – 20A - 230V AC

AA21107MT	20A - Switch - 1 Way - 1 Module	798	1/10/100
AA21108MT	20A - Switch - 1 Way - with Indicator - 1 Module	920	1/10/100
AA22106MT	20A - Switch - 2 Way - 1 Module	1034	1/10/100
AA22108MT	20A - Switch - 2 Way - with Indicator - 1 Module	1148	1/10/100

* MRP - Maximum Retail Price Inclusive of all taxes including GST.
Red Cat. Nos - New Products

Bold Cat.Nos are products normally available with Legrand (India) Stockists. Cat.Nos that are not bold - delivery within 4 - 8 weeks from the date of order. Bold packing quantity is our mandatory packing. Orders to be placed by Legrand (India) Stockist in multiples of the same.

Arteor Advance™

NEW! Elite - Matt Titanium Mechanisms

Cat.Nos	Description	MRP* ₹ / Unit	Pack
---------	-------------	------------------	------

Push Button – 10A - 230V AC

AA23102MT	10A - Bell Push - 1 Way - 1 Module	654	1/10/100
AA23103MT	10A - Bell Push - 1 Way - with Locator - 1 Module	902	1/10/100
AA23101MT	10A - Push Button - 1 Way - 1 Module	680	1/10/100
AA23108MT	10A - Push Button - 2 Way - 1 Module	996	1/5/50

Electric Roller Blinds and Curtain Control

AA26104MT	Double Switch for Electric Shutter - 2 Module	1650	1/5/50
------------------	---	------	--------

Dimmers and Fan Regulators

AA24107MT	Rotary Dimmer 200W LED - 2 Module	26138	1/10
AA667MT	Fan Step Regulator - 70 Watts - ISI - 2 Module	2904	1/3/30
AA664MT	Fan Regulator - 8 Step - 100 Watts - ISI - 2 Module	2598	1/3/30
AA669MT	Fan Step Regulator - 120 Watts - ISI - 2 Module	2928	1/3/30

Temperature Room Control Unit

AA674MT	Temperature Room Control Unit	23578	1/20
----------------	-------------------------------	-------	------

USB Chargers

AA3406MT	USB Charger - Power Delivery - 30 Watts - Type C + C - 2 Module	13318	1/20
AA3401MT	USB Charger - Power Delivery - 45 Watts - Type C - 2 Module	17184	1/20

Hospitality Function

Cat.Nos	Description	MRP* ₹ / Unit	Pack
---------	-------------	------------------	------

Hotel "DND and MMR" functions

AA27107MT	Interlocked Internal DND & MMR Control Unit - 2 Module	3278	1/5/50
AA27108MT	External DND & MMR Control Unit - with Bell Push - 2 Module	4532	1/5/50

Arteor Advance™

NEW! Classic- Cover Plate with Support Frame

Cat.Nos	Description	MRP* ₹ / Unit	Pack
---------	-------------	------------------	------

Master Push Button

AA23115MT	Master Push ON/OFF - 2 Way - 1 Module	1088	1/10/100
------------------	---------------------------------------	------	----------

Bedlight Switch

AA21117MT	10A - Bedlight Switch - 2 Way - 2X1 2 Module	1088	1/5/50
AA23119MT	10A - Push for Bedlight - 2 Way - 2X1 2 Module	1088	1/5/50

Blanking Plate

AA150MT	Blanking Plate - 1 Module	98	1/10/100
----------------	---------------------------	----	----------

White Cover Plate with Support Frame

AC1200MW	Cover Plate + Frame - 1 Module - Matt White	510	10/100
AC1201MW	Cover Plate + Frame - 2 Module - Matt White	528	10/100
AC1202MW	Cover Plate + Frame - 3 Module - Matt White	612	10/100
AC1203MW	Cover Plate + Frame - 4 Module - Matt White	700	5/50
AC1205MW	Cover Plate + Frame - 6 Module - Matt White	964	5/30
AC1207MW	Cover Plate + Frame - 8 Module - Matt White	1140	5/30
AC1208MW	Cover Plate + Frame - 2*4 Module - Matt White	1666	2/20
AC1212MW	Cover Plate + Frame - 9 Module - Matt White	1768	5/30
AC1210MW	Cover Plate + Frame - 2*6 Module - Matt White	2216	2/16
AC1213MW	Cover Plate + Frame - 2*8 Module - Matt White	2436	2/16
AC1211MW	Cover Plate + Frame - 3*6 Module - Matt White	2872	2/12
AC1136MW	Cover Plate - for Shaver Socket-3 Module - Matt White	638	5/50

Matt Black Cover Plate with Support Frame

AC1200MB	Cover Plate + Frame - 1 Module - Matt Black	614	10/100
AC1201MB	Cover Plate + Frame - 2 Module - Matt Black	648	10/100
AC1202MB	Cover Plate + Frame - 3 Module - Matt Black	686	10/100
AC1203MB	Cover Plate + Frame - 4 Module - Matt Black	778	5/50
AC1205MB	Cover Plate + Frame - 6 Module - Matt Black	1330	5/30

* MRP - Maximum Retail Price Inclusive of all taxes including GST.
Red Cat. Nos - New Products

Bold Cat.Nos are products normally available with Legrand (India) Stockists. Cat.Nos that are not bold - delivery within 4 - 8 weeks from the date of order. Bold packing quantity is our mandatory packing. Orders to be placed by Legrand (India) Stockist in multiples of the same.

Arteor Advance™

NEW!

Classic- Cover Plate with Support Frame

Cat.Nos	Description	MRP* ₹ / Unit	Pack
Matt Black Cover Plate with Support Frame			
AC1207MB	Cover Plate + Frame - 8 Module - Matt Black	1476	5/30
AC1208MB	Cover Plate + Frame - 2*4 Module - Matt Black	1872	2/20
AC1212MB	Cover Plate + Frame - 9 Module - Matt Black	1986	5/30
AC1210MB	Cover Plate + Frame - 2*6 Module - Matt Black	2430	2/16
AC1213MB	Cover Plate + Frame - 2*8 Module - Matt Black	2760	2/16
AC1211MB	Cover Plate + Frame - 3*6 Module - Matt Black	3226	2/12
AC1136MB	Cover Plate - for Shaver Socket-3 Module - Matt Black	1048	5/50

Matt Titanium Cover Plate with Support Frame

AC1200MT	Cover Plate + Frame - 1 Module - Matt Titanium	614	10/100
AC1201MT	Cover Plate + Frame - 2 Module - Matt Titanium	648	10/100
AC1202MT	Cover Plate + Frame - 3 Module - Matt Titanium	686	10/100
AC1203MT	Cover Plate + Frame - 4 Module - Matt Titanium	778	5/50
AC1205MT	Cover Plate + Frame - 6 Module - Matt Titanium	1330	5/30
AC1207MT	Cover Plate + Frame - 8 Module - Matt Titanium	1476	5/30
AC1208MT	Cover Plate + Frame - 2*4 Module - Matt Titanium	1872	2/20
AC1212MT	Cover Plate + Frame - 9 Module - Matt Titanium	1986	5/30
AC1210MT	Cover Plate + Frame - 2*6 Module - Matt Titanium	2430	2/16
AC1213MT	Cover Plate + Frame - 2*8 Module - Matt Titanium	2760	2/16
AC1211MT	Cover Plate + Frame - 3*6 Module - Matt Titanium	3226	2/12
AC1136MT	Cover Plate - for Shaver Socket-3 Module - Matt Titanium	1048	5/50

Frosted White Cover Plate with Support Frame

AC1200FW	Cover Plate + Frame - 1 Module - Frosted White	788	1/5/30
AC1201FW	Cover Plate + Frame - 2 Module - Frosted White	842	1/5/30
AC1202FW	Cover Plate + Frame - 3 Module - Frosted White	902	1/20
AC1203FW	Cover Plate + Frame - 4 Module - Frosted White	960	1/20

Arteor Advance™

NEW!

Classic- Cover Plate with Support Frame

Cat.Nos	Description	MRP* ₹ / Unit	Pack
Frosted White Cover Plate with Support Frame			
AC1205FW	Cover Plate + Frame - 6 Module - Frosted White	1746	1/5/30
AC1207FW	Cover Plate + Frame - 8 Module - Frosted White	1922	1/5/30
AC1208FW	Cover Plate + Frame - 2*4 Module - Frosted White	2482	1/10
AC1210FW	Cover Plate + Frame - 2*6 Module - Frosted White	2998	1/16
AC1136FW	Cover Plate - for Shaver Socket-3 Module - Frosted White	1840	1/5/50

Frosted Black Cover Plate with Support Frame

AC1200FB	Cover Plate + Frame - 1 Module - Frosted Black	788	1/5/30
AC1201FB	Cover Plate + Frame - 2 Module - Frosted Black	842	1/5/30
AC1202FB	Cover Plate + Frame - 3 Module - Frosted Black	902	1/20
AC1203FB	Cover Plate + Frame - 4 Module - Frosted Black	960	1/20
AC1205FB	Cover Plate + Frame - 6 Module - Frosted Black	1746	1/5/30
AC1207FB	Cover Plate + Frame - 8 Module - Frosted Black	1922	1/5/30
AC1208FB	Cover Plate + Frame - 2*4 Module - Frosted Black	2482	1/10
AC1210FB	Cover Plate + Frame - 2*6 Module - Frosted Black	2998	1/16
AC1136FB	Cover Plate - for Shaver Socket-3 Module - Frosted Black	1840	1/5/50

Brushed Stainless Steel Cover Plate with Support Frame

AC1200BS	Cover Plate + Frame - 1 Module - Brushed Stainless Steel	3596	1/5/30
AC1201BS	Cover Plate + Frame - 2 Module - Brushed Stainless Steel	3844	1/5/30
AC1202BS	Cover Plate + Frame - 3 Module - Brushed Stainless Steel	4134	1/20
AC1203BS	Cover Plate + Frame - 4 Module - Brushed Stainless Steel	4388	1/20

* MRP - Maximum Retail Price Inclusive of all taxes including GST.
Red Cat. Nos - New Products

Bold Cat.Nos are products normally available with Legrand (India) Stockists. Cat.Nos that are not bold - delivery within 4 - 8 weeks from the date of order. Bold packing quantity is our mandatory packing. Orders to be placed by Legrand (India) Stockist in multiples of the same.

Arteor Advance™

NEW! Classic- Cover Plate with Support Frame

Cat.Nos	Description	MRP* ₹ / Unit	Pack
AC1205BS	Cover Plate + Frame - 6 Module - Brushed Stainless Steel	7986	1/5/30
AC1207BS	Cover Plate + Frame - 8 Module - Brushed Stainless Steel	8782	1/5/30
AC1208BS	Cover Plate + Frame - 2*4 Module - Brushed Stainless Steel	11100	1/10
AC1210BS	Cover Plate + Frame - 2*6 Module - Brushed Stainless Steel	13682	1/16
AC1136BS	Cover Plate - for Shaver Socket-3 Module - Brushed Stainless Steel	4098	1/5/50

Solid Aluminium Cover Plate with Support Frame

AC1200SA	Cover Plate + Frame - 1 Module - Solid Aluminium	5134	1/5/30
AC1201SA	Cover Plate + Frame - 2 Module - Solid Aluminium	5494	1/5/30
AC1202SA	Cover Plate + Frame - 3 Module - Solid Aluminium	5908	1/20
AC1203SA	Cover Plate + Frame - 4 Module - Solid Aluminium	6270	1/20
AC1205SA	Cover Plate + Frame - 6 Module - Solid Aluminium	11408	1/5/30
AC1207SA	Cover Plate + Frame - 8 Module - Solid Aluminium	12544	1/5/30
AC1208SA	Cover Plate + Frame - 2*4 Module - Solid Aluminium	15856	1/10
AC1210SA	Cover Plate + Frame - 2*6 Module - Solid Aluminium	19546	1/16
AC1136SA	Cover Plate - for Shaver Socket-3 Module - Solid Aluminium	5854	1/5/50

Midnight Blue Cover Plate with Support Frame

AC1200NB	Cover Plate + Frame - 1 Module - Midnight Blue	5134	1/5/30
AC1201NB	Cover Plate + Frame - 2 Module - Midnight Blue	5494	1/5/30

Arteor Advance™

NEW! Elite- Cover Plate with Support Frame

Cat.Nos	Description	MRP* ₹ / Unit	Pack
AC1202NB	Cover Plate + Frame - 3 Module - Midnight Blue	5908	1/20
AC1203NB	Cover Plate + Frame - 4 Module - Midnight Blue	6270	1/20
AC1205NB	Cover Plate + Frame - 6 Module - Midnight Blue	11408	1/5/30
AC1207NB	Cover Plate + Frame - 8 Module - Midnight Blue	12544	1/5/30
AC1208NB	Cover Plate + Frame - 2*4 Module - Midnight Blue	15856	1/10
AC1210NB	Cover Plate + Frame - 2*6 Module - Midnight Blue	19546	1/16
AC1136NB	Cover Plate - for Shaver Socket-3 Module - Midnight Blue	5854	1/5/50

Round Plates with Support Frame

AA1202MW	Cover Plate + Frame - 2 Module - Round - Matt White	658	10/100
AA1202MB	Cover Plate + Frame - 2 Module - Round - Matt Black	808	10/100
AA1202MT	Cover Plate + Frame - 2 Module - Round - Matt Titanium	808	10/100

Frosted White Cover Plate with Support Frame

AA1200FW	Cover Plate + Frame - 1 Module - 1 x Elite - Frosted White	984	1/5/30
AA1201FW	Cover Plate + Frame - 2 Module - 2 x Elite - Frosted White	1054	1/5/30
AA1202FW	Cover Plate + Frame - 2 Module - Round - Frosted White	1054	1/5/30
AA1203FW	Cover Plate + Frame - 3 Module - 3 x Elite - Frosted White	1130	1/20
AA1204FW**	Cover Plate + Frame - 4 Module - 4 x Elite - Frosted White	1248	1/5/30

* MRP - Maximum Retail Price Inclusive of all taxes including GST.
**Lead Time : 8 - 10 weeks after order booking
Red Cat. Nos - New Products

Bold Cat.Nos are products normally available with Legrand (India) Stockists.
Cat.Nos that are not bold - delivery within 4 - 8 weeks from the date of order.
Bold packing quantity is our mandatory packing. Orders to be placed by
Legrand (India) Stockist in multiples of the same.

Arteor Advance™

NEW! Elite- Cover Plate with Support Frame

Cat.Nos	Description	MRP* ₹ / Unit	Pack
AA1200FB	Cover Plate + Frame - 1 Module - 1 x Elite - Frosted Black	984	1/5/30
AA1201FB	Cover Plate + Frame - 2 Module - 2 x Elite - Frosted Black	1054	1/5/30
AA1202FB	Cover Plate + Frame - 2 Module - Round - Frosted Black	1054	1/5/30
AA1203FB	Cover Plate + Frame - 3 Module - 3 x Elite - Frosted Black	1130	1/20
AA1204FB**	Cover Plate + Frame - 4 Module - 4 x Elite - Frosted Black	1248	1/5/30

Brushed Stainless Steel Cover Plate with Support Frame

AA1200BS	Cover Plate + Frame - 1 Module - 1 x Elite - Brushed Stainless Steel	4492	1/5/30
AA1201BS	Cover Plate + Frame - 2 Module - 2 x Elite - Brushed Stainless Steel	4806	1/5/30
AA1202BS	Cover Plate + Frame - 2 Module - Round - Brushed Stainless Steel	4806	1/5/30
AA1203BS	Cover Plate + Frame - 3 Module - 3 x Elite - Brushed Stainless Steel	5170	1/20

Solid Aluminium Cover Plate with Support Frame

AA1200SA	Cover Plate + Frame - 1 Module - 1 x Elite - Solid Aluminium	6418	1/5/30
AA1201SA	Cover Plate + Frame - 2 Module - 2 x Elite - Solid Aluminium	6870	1/5/30
AA1202SA	Cover Plate + Frame - 2 Module - Round - Solid Aluminium	6870	1/5/30
AA1203SA	Cover Plate + Frame - 3 Module - 3 x Elite - Solid Aluminium	7386	1/20
AA1204SA**	Cover Plate + Frame - 4 Module - 4 x Elite - Solid Aluminium	8150	1/5/30

* MRP - Maximum Retail Price Inclusive of all taxes including GST.
**Lead Time : 8 - 10 weeks after order booking
Red Cat. Nos - New Products

Arteor Advance™



NEW! Hybrid(Classic+Elite)- Cover Plate with Support Frame

Cat.Nos	Description	MRP* ₹ / Unit	Pack
AA1200NB	Cover Plate + Frame - 1 Module - 1 x Elite - Midnight Blue	6418	1/5/30
AA1201NB	Cover Plate + Frame - 2 Module - 2 x Elite - Midnight Blue	6870	1/5/30
AA1202NB	Cover Plate + Frame - 2 Module - Round - Midnight Blue	6870	1/5/30
AA1203NB	Cover Plate + Frame - 3 Module - 3 x Elite - Midnight Blue	7386	1/20
AA1204NB**	Cover Plate + Frame - 4 Module - 4 x Elite - Midnight Blue	8150	1/5/30

Frosted White Cover Plate with Support Frame

AB1208FW	Cover Plate + Frame - 4 Module - 2 x Classic + 2 x Elite - Frosted White	1248	1/20
AB1203FW	Cover Plate + Frame - 6 Module - 3 x Classic + 2 x Elite - Frosted White	2270	1/5/30
AB1205FW	Cover Plate + Frame - 6 Module - 4 x Classic + 1 x Elite - Frosted White	2270	1/5/30
AB1202FW	Cover Plate + Frame - 6 Module - 3 x Classic + Round - Frosted White	2270	1/5/30
AB1207FW	Cover Plate + Frame - 8 Module - 5 x Classic + Round - Frosted White	2498	1/5/30

Frosted Black Cover Plate with Support Frame

AB1208FB	Cover Plate + Frame - 4 Module - 2 x Classic + 2 x Elite - Frosted Black	1248	1/20
AB1203FB	Cover Plate + Frame - 6 Module - 3 x Classic + 2 x Elite - Frosted Black	2270	1/5/30
AB1205FB	Cover Plate + Frame - 6 Module - 4 x Classic + 1 x Elite - Frosted Black	2270	1/5/30
AB1202FB	Cover Plate + Frame - 6 Module - 3 x Classic + Round - Frosted Black	2270	1/5/30
AB1207FB	Cover Plate + Frame - 8 Module - 5 x Classic + Round - Frosted Black	2498	1/5/30

Bold Cat.Nos are products normally available with Legrand (India) Stockists.
Cat.Nos that are not bold - delivery within 4 - 8 weeks from the date of order.
Bold packing quantity is our mandatory packing. Orders to be placed by
Legrand (India) Stockist in multiples of the same.

Hybrid(Classic+Elite)- Cover Plate with Support Frame

NEW!

Cat.Nos	Description	MRP* ₹ / Unit	Pack
Brushed Stainless Steel Cover Plate with Support Frame			
AB1208BS	Cover Plate + Frame - 4 Module - 2 x Classic + 2 x Elite - Brushed Stainless Steel	5704	1/20
AB1203BS	Cover Plate + Frame - 6 Module - 3 x Classic + 2 x Elite - Brushed Stainless Steel	10382	1/5/30
AB1205BS	Cover Plate + Frame - 6 Module - 4 x Classic + 1 x Elite - Brushed Stainless Steel	10382	1/5/30
AB1202BS	Cover Plate + Frame - 6 Module - 3 x Classic + Round - Brushed Stainless Steel	10382	1/5/30
AB1207BS	Cover Plate + Frame - 8 Module - 5 x Classic + Round - Brushed Stainless Steel	11418	1/5/30



AB1205BS



AB1202BS



AB1207BS

Solid Aluminium Cover Plate with Support Frame

AB1208SA	Cover Plate + Frame - 4 Module - 2 x Classic + 2 x Elite - Solid Aluminium	8150	1/20
AB1203SA	Cover Plate + Frame - 6 Module - 3 x Classic + 2 x Elite - Solid Aluminium	14832	1/5/30
AB1205SA	Cover Plate + Frame - 6 Module - 4 x Classic + 1 x Elite - Solid Aluminium	14832	1/5/30
AB1202SA	Cover Plate + Frame - 6 Module - 3 x Classic + Round - Solid Aluminium	14832	1/5/30
AB1207SA	Cover Plate + Frame - 8 Module - 5 x Classic + Round - Solid Aluminium	16306	1/5/30



AB1208SA



AB1203SA



AB1202SA

Midnight Blue Cover Plate with Support Frame

AB1208NB	Cover Plate + Frame - 4 Module - 2 x Classic + 2 x Elite - Midnight Blue	8150	1/20
AB1203NB	Cover Plate + Frame - 6 Module - 3 x Classic + 2 x Elite - Midnight Blue	14832	1/5/30



AB1208NB



AB1205NB



AB1202NB



6890 07



6890 09



6890 10



6890 12

Hybrid(Classic+Elite)- Cover Plate with Support Frame

NEW!

Cat.Nos	Description	MRP* ₹ / Unit	Pack
AB1205NB	Cover Plate + Frame - 6 Module - 4 x Classic + 1 x Elite - Midnight Blue	14832	1/5/30
AB1202NB	Cover Plate + Frame - 6 Module - 3 x Classic + Round - Midnight Blue	14832	1/5/30
AB1207NB	Cover Plate + Frame - 8 Module - 5 x Classic + Round - Midnight Blue	16306	1/5/30

Arteor Advance™







Accessories- Metal Flush Boxes

6890 07	Metal Flush Box - 1/2 Module	170	40
6890 08	Metal Flush Box - 3 Module	170	40
6890 09	Metal Flush Box - 4 Module	226	40
6890 10	Metal Flush Box - 6 Module	358	40
6890 42	Metal Flush Box - 8 Module	416	40
6890 31	Metal Flush Box - 4*2 Module	414	20
6890 29	Metal Flush Box - 9 Module	490	20
6890 11	Metal Flush Box -12 Module	624	10
6890 13	Metal Flush Box -16 Module	720	10
6890 12	Metal Flush Box - 18 Module	788	10

* MRP - Maximum Retail Price Inclusive of all taxes including GST.
Red Cat. Nos - New Products

Arteor Advance™

NEW! Accessories- Metal Flush Boxes

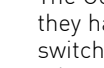
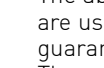
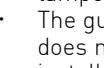
Cat.Nos	Description	MRP* ₹ / Unit	Pack
Surface Mounting Boxes			
 A1605WH	Plastic Surface Box - 1/2 Module	166	55
 A1606WH	Plastic Surface Box - 3 Module	202	42
 A1607WH	Plastic Surface Box - 4 Module	238	27
 A1608WH	Plastic Surface Box - 6 Module	298	20
 A1609WH	Plastic Surface Box - 8 Module	336	20
 A1611WH	Plastic Surface Box - 4*2 Module	410	10
 A1610WH	Plastic Surface Box - 9 Module	422	18
 A1612WH	Plastic Surface Box - 12 Module	1046	11
 A1614WH	Plastic Surface Box - 16 Module	1078	11
 A1613WH	Plastic Surface Box - 18 Module	1106	8

Arteor Advance™

Guarantee

- The Company, at its discretion, will replace products if they have any manufacturing defect within 10 years for switches (without LED lamp) and power sockets. For all other **Arteor Advance™** wiring accessories the guarantee will be 2 years.
- The above guarantee is applicable when the devices are used in Legrand metal flush boxes. Otherwise the guarantee period will be reduced by 50%.
- The guarantee is only applicable when the products are installed as per the Company's instructions and not tampered in any manner.
- The guarantee states the Company's entire liability. It does not extend to cover consequential loss or damage or installation costs arising from defective products.

Our switches are compliant with revised BIS standard (IS 3854:2023) requirements. Also, our switches are covered additionally for use on Self-Ballasted Lamp (SBL) loads.

SBL power rating as per IS3854:2023

Switch Rating	6A, 230V~	10A, 230V~	16A, 230V~	20A, 230V~
SBL power (Watt)	100 W	100 W	200 W	250 W

* MRP - Maximum Retail Price Inclusive of all taxes including GST.
Red Cat. Nos - New Products

Smart Home

One system - two technologies



Simply smart
Arteor™ Advance WITH IoT



Home + Control

Arteor Advance with IoT is the ideal solution for medium-sized projects and modernisation. The smart range is Zigbee 3.0 compatible and Wi-Fi enabled, using conventional cabling, making it easy to install, expand and modify. It is available for all common installation standards and used almost anywhere in the world. The Home + Control app is used for configuration, monitoring and control on a day-to-day basis, and installations can also be operated via the switch or using a voice assistant.



Smart Zigbee / Wi-Fi gateway



Smart fan controller 4 speeds

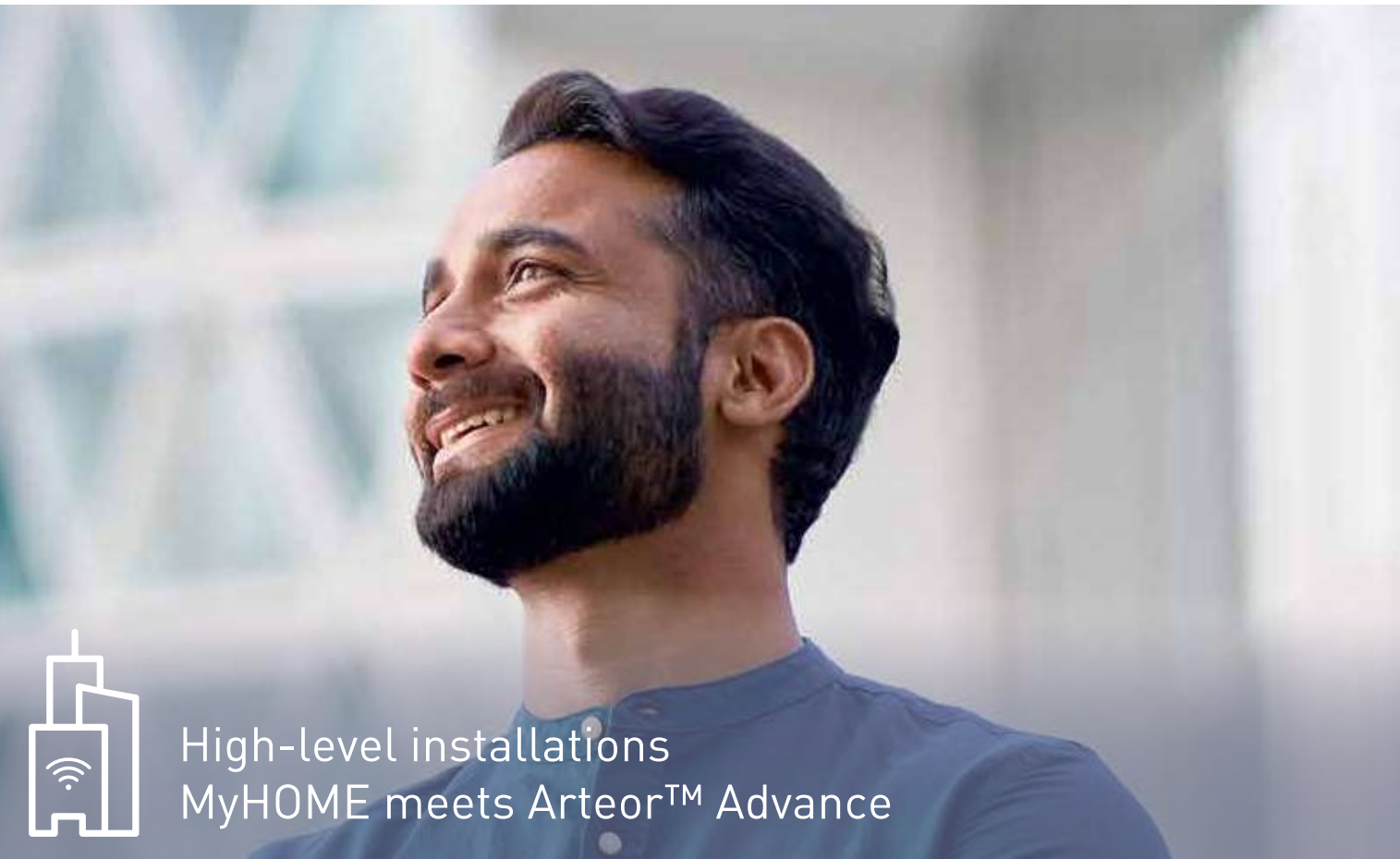

High-level installations MyHOME meets Arteor™ Advance

Arteor Advance also offers the Bus-based MyHOME solution for comprehensive new-build big installations such as villas or projects where all functions need to be fully automated. More powerful than before, MyHOME enables configuration of up to 525 addresses with the new address extension interface. The MyHOME installation can be configured with the Home + Project app and controlled via the Home + Control app, HOMETOUCH screen and voice assistants.



Home + Control



Home + Project



New MyHOME Server -
available also in a version
for third party integration



DALI-2 compatible
dimming



Multifunction control

Smart Home



Smarter living

Whether radio solution or Bus-based system: Arteor Advance offers all the components needed to make a modern home smart, including switches, dimmers, controls for shading systems, fan controllers for smart ventilation control among others. Smart socket outlets for remote switching of standard lamps and other electrical devices, scene switches and Bus-based multifunction controls expand the number of possible options.



Lighting control: Wireless switches are available with battery and in a batteryless version: for less maintenance effort and lower environmental impact.



Individual, group or centralised control of shutters, shades and curtains



Fan controllers ensure a comfortable individual temperature.



Preprogrammed or customised scenes for greater comfort



Smart socket outlets – easy remote switching of standard lamps and other electrical devices



Bus dimming control



Bus control for shutters and shades



Bus 4 scenes control

Maximum functionality in a minimum of space.

The new Bus-based multifunction controls provide an improved control experience and optimise the management of groups and scenes in a minimum of space: Up to 4 functions in 2 modules or up to 6 functions in 3 modules can be combined to suit individual requirements and personalised with new dedicated Arteor Advance key covers. A perfect blend of design and functionality for a premium control experience.



Better design for KNX experts



KNX is a widely used option whenever sophisticated automation is required for luxury villas and tertiary buildings. Blending technological performance with style, Arteor Advance KNX enables system integrators to realise complex automation projects with a spectacular design.

Arteor Advance KNX solutions offer full interoperability with all third-party applications and systems. It will thus be possible to create advanced solutions for the intelligent management of comfort and energy saving functions in hotels, hospitals, tertiary and luxury residential environments.

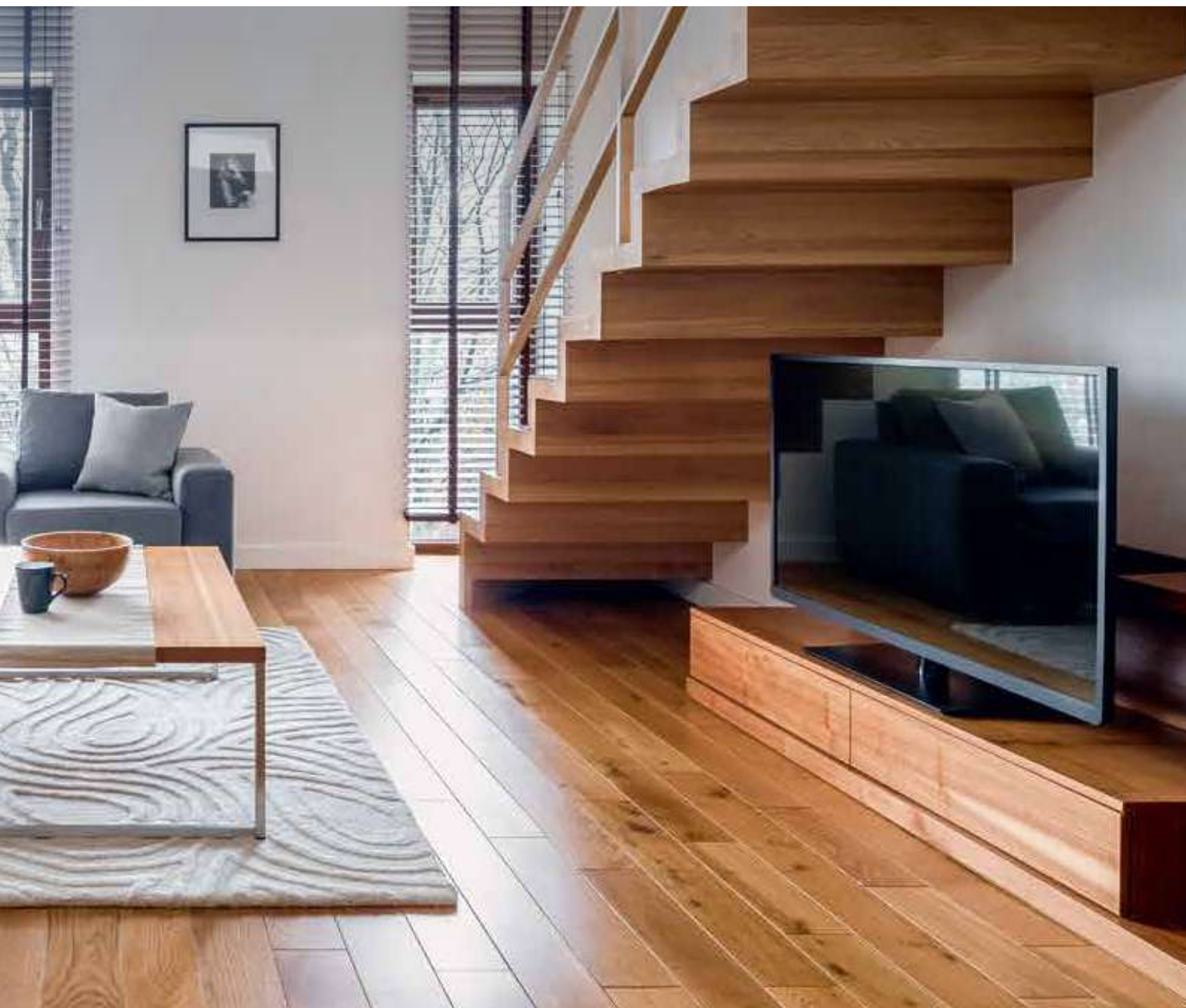

Multifunction control

KNX certified control device for perfect interoperability between Arteor Advance and third-party KNX products. Enabling management of up to 4 functions, it is configurable with ETS software and editable at any time. Arteor Advance key covers will add a touch of elegance to the control unit.

Arteor™ Advance KNX



Lighting control

For ON/OFF and dimming control of standard and multicolour lamps.



Shutter control

For control of shutters and awnings. Raise/lower/stop function and memorisation of favourite position.



Temperature control

Setting temperature, fan speed and control modes for any kind of HVAC: ON-OFF valves, ON-OFF and 0-10V floor control units or VRV/VRF systems



Scenes

Just one touch for setting lights, shutters and temperature to create comfort scenes and to save energy.



Open for everything: Arteor™ Advance and KNX

The KNX solutions from the Arteor Advance range can be integrated into an active general building management system. Not only for an optimum control of lighting, shutters, temperature and scenes. System integrators are also free to complete their projects with products from different manufacturers for security functions or heating and ventilation. It is also possible to display energy consumption or to be alerted when a fault occurs.



Touch Screen

Full KNX control on 15 pages including energy metering value display, timed functions, scene group function and logic functions.



Controller

Modular multifunction controller for On/Off control of lighting, shutters and HVAC with the same device. Designed for centralized installation with maximum flexibility.

















Presence Sensors

For advanced automation functions required in any “green” building. More energy efficiency through programmed lighting maintenance and scenario triggering dependent on presence / absence, natural light level or time.

Arteor Advance™ IoT













NEW! Connected Homes-Classic Matt White Mechanism

Cat.Nos	Description	MRP* ₹ / Unit	Pack
Connected Light Switches			
 AC52113MW	Classic - Connected Switch - with Neutral - Wired - 1 Module	11860	1/5/20
 AC52112MW	Classic - Connected Switch Dimmer - with Neutral - 150 Watts - 1 Module	13622	1/5/50
Connected Outlets			
 AC5412MW	Classic - 16A - Connected Socket Module - 1 Module	13508	1/5/50
Connected Curtain/Roller Blind Switches			
 AC5310MW	Classic - Connected Curtain/Roller Blind Switch - Wired - 1 Module	14424	1/5/20
Connected Step Fan controller			
 AC5510MW	Classic - Connected Step Fan Controller - with Neutral -100W - 2 Module	9988	1/10
Connected Gateway Pack			
 AC5110MW	Connected Gateway - Wired - 2 Module	21540	1/1/10
Wireless Control Switch			
 AC5201MW	Classic - 1 Gang - Wireless Switch - 2 Module	4914	1/5/30
 AC5202MW	Classic - 2 Gang - Wireless Switch - 2 Module	5214	1/5/30
 AC5203MW	Classic - 3 Gang - Wireless Switch - 2 Module	6410	1/5/30
Wireless Scenario Control Switch			
 AC5700MW	Classic - Wireless 4 Scenario Control Switch - 2 Module	9000	1/5/20
 AC5701MW	Classic - Home/Away Wireless Master Switch - 2 Module	7206	1/5/30
 AC5702MW	Classic - Wake Up/Sleep Wireless Scenario Control Switch - 2 Module	5214	1/5/30
IN Wall Wireless Switch			
 AC5200MW	Classic - In-Wall - Wireless Switch - 1 Module	6158	1/5/20
 AC5501MW	Classic - In Wall Wireless - Fan Control Switch - 1 Module	8952	1/5/20
 AC5300MW	Classic - In Wireless - Curtain/Roller Blind Switch - 1 Module	7104	1/5/20

* MRP - Maximum Retail Price Inclusive of all taxes including GST.
Red Cat. Nos - New Products

Arteor Advance™ IoT

NEW! Connected Homes-Classic Matt White Mechanism

Cat.Nos	Description	MRP* ₹ / Unit	Pack
IN Wall Wireless Switch			
 AC5703MW	Classic - In Wall Wake Up/Sleep Wireless Switch - 1 Module	7206	1/5/20
 AC5704MW	Classic - In Wall Home/Away Wireless Switch - 1 Module	7206	1/5/20
Wireless Batteryless Switch			
 AC5206MW	Classic - Wireless - Batteryless - 1 Gang - Control Switch - 2 Module	22226	1/10
 AC5207MW	Classic - Wireless - Batteryless - 2 Gang - Control Switch - 2 Module	25216	1/10
 AC5302MW	Classic - Wireless - Batteryless - Curtain/Roller Blind Switch - 2 Module	18470	1/10
 AC5707MW	Classic - Wireless - Batteryless - Home/Away Master Switch - 2 Module	18370	1/10
 AC5708MW	Classic - Wireless - Batteryless - Wake Up/Sleep Scenario Switch - 2 Module	18736	1/10
 AC5705MW	Classic - Wireless - Batteryless - 4 Scenario Switch - 2 Module	23400	1/10
Connected Homes-Classic Matt Titanium Mechanism			
Connected Light Switches			
 AC52113MT	Classic - Connected Switch - with Neutral - Wired - 1 Module	13642	1/5/20
 AC52112MT	Classic - Connected Switch Dimmer - with Neutral - 150 Watts - 1 Module	15660	1/5/50
Connected Outlets			
 AC5412MT	Classic - 16A - Connected Socket Module - 1 Module	15690	1/5/50
Connected Curtain/Roller Blind Switches			
 AC5310MT	Classic - Connected Curtain/Roller Blind Switch - Wired - 1 Module	16584	1/5/20
Connected Step Fan controller			
 AC5510MT	Classic - Connected Step Fan Controller - with Neutral -100W - 2 Module	11484	1/10

Bold Cat.Nos are products normally available with Legrand (India) Stockists. Cat.Nos that are not bold - delivery within 4 - 8 weeks from the date of order. Bold packing quantity is our mandatory packing. Orders to be placed by Legrand (India) Stockist in multiples of the same.

Arteor Advance™ IoT

NEW! Connected Homes-Classic Matt Titanium Mechanism



Cat.Nos	Description	MRP* ₹ / Unit	Pack
Connected Gateway Pack			
AC5110MT	Connected Gateway - Wired - 2 Module	24764	1/1/10
Wireless Control Switch			
AC5201MT	Classic - 1 Gang - Wireless Switch - 2 Module	5654	1/5/30
AC5202MT	Classic - 2 Gang - Wireless Switch - 2 Module	5998	1/5/30
AC5203MT	Classic - 3 Gang - Wireless Switch - 2 Module	7374	1/5/30
Wireless Scenario Control Switch			
AC5700MT	Classic - Wireless 4 Scenario Control Switch - 2 Module	10352	1/5/20
AC5701MT	Classic - Home/Away Wireless Master Switch - 2 Module	8292	1/5/30
AC5702MT	Classic - Wake Up/Sleep Wireless Scenario Control Switch - 2 Module	5998	1/5/30
IN Wall Wireless Switch			
AC5200MT	Classic - In Wall - Wireless Switch - 1 Module	7154	1/5/20
AC5501MT	Classic - In Wall - Wireless - Fan Control Switch - 1 Module	10294	1/5/20
AC5300MT	Classic - In Wall - Wireless - Curtain/Roller Blind Switch - 1 Module	8170	1/5/20
AC5703MT	Classic - In Wall Wake Up/Sleep Wireless Switch - 1 Module	8292	1/5/20
AC5704MT	Classic - In Wall Home/Away Wireless Switch - 1 Module	8292	1/5/20
Wireless Batteryless Switch			
AC5206MT	Classic - Wireless - Batteryless - 1 Gang - Control Switch - 2 Module	25562	1/10
AC5207MT	Classic - Wireless - Batteryless - 2 Gang - Control Switch - 2 Module	29002	1/10
AC5302MT	Classic - Wireless - Batteryless - Curtain/Roller Blind Switch - 2 Module	21238	1/10
AC5707MT	Classic - Wireless - Batteryless - Home/Away Master Switch - 2 Module	21128	1/10
AC5708MT	Classic - Wireless - Batteryless - Wake Up/Sleep Scenario Switch - 2 Module	21546	1/10
AC5705MT	Classic - Wireless - Batteryless - 4 Scenario Switch - 2 Module	26910	1/10

* MRP - Maximum Retail Price Inclusive of all taxes including GST.
Red Cat. Nos - New Products

Arteor Advance™ IoT

NEW! Connected Homes-Classic Matt Black Mechanism



Cat.Nos	Description	MRP* ₹ / Unit	Pack
Connected Light Switches			
AC52113MB	Classic - Connected Switch - with Neutral - Wired - 1 Module	13642	1/5/20
AC52112MB	Classic - Connected Switch Dimmer - with Neutral - 150 Watts - 1 Module	15660	1/5/50
Connected Outlets			
AC5412MB	Classic - 16A - Connected Socket Module - 1 Module	15690	1/5/50
Connected Curtain/Roller Blind Switches			
AC5310MB	Classic - Connected Curtain/Roller Blind Switch - Wired - 1 Module	16584	1/5/20
Connected Step Fan controller			
AC5510MB	Classic - Connected Step Fan Controller - with Neutral - 100W - 2 Module	11484	1/10
Connected Gateway Pack			
AC5110MB	Connected Gateway - Wired - 2 Module	24764	1/1/10
Wireless Control Switch			
AC5201MB	Classic - 1 Gang - Wireless Switch - 2 Module	5654	1/5/30
AC5202MB	Classic - 2 Gang - Wireless Switch - 2 Module	5998	1/5/30
AC5203MB	Classic - 3 Gang - Wireless Switch - 2 Module	7374	1/5/30
Wireless Scenario Control Switch			
AC5700MB	Classic - Wireless 4 Scenario Control Switch - 2 Module	10352	1/5/20
AC5701MB	Classic - Home/Away Wireless Master Switch - 2 Module	8292	1/5/30
AC5702MB	Classic - Wake Up/Sleep Wireless Scenario Control Switch - 2 Module	5998	1/5/30
IN Wall Wireless Switch			
AC5200MB	Classic - In Wall - Wireless Switch - 1 Module	7154	1/5/20
AC5501MB	Classic - In Wall - Wireless - Fan Control Switch - 1 Module	10294	1/5/20
AC5300MB	Classic - In Wall - Wireless - Curtain/Roller Blind Switch - 1 Module	8170	1/5/20
AC5703MB	Classic - In Wall Wake Up/Sleep Wireless Switch - 1 Module	8292	1/5/20

Bold Cat.Nos are products normally available with Legrand (India) Stockists. Cat.Nos that are not bold - delivery within 4 - 8 weeks from the date of order. Bold packing quantity is our mandatory packing. Orders to be placed by Legrand (India) Stockist in multiples of the same.

Arteor Advance™ IoT

NEW! Connected Homes-Classic Matt Black Mechanism

Cat.Nos	Description	MRP* ₹ / Unit	Pack
---------	-------------	------------------	------

IN Wall Wireless Switch

AC5704MB	Classic - In Wall Home/Away Wireless Switch - 1 Module	8292	1/5/20
-----------------	--	------	--------

Wireless Batteryless Switch

AC5206MB	Classic - Wireless - Batteryless - 1 Gang - Control Switch - 2 Module	25562	1/10
AC5207MB	Classic - Wireless - Batteryless - 2 Gang - Control Switch - 2 Module	29002	1/10
AC5302MB	Classic - Wireless - Batteryless - Curtain/Roller Blind Switch - 2 Module	21238	1/10
AC5707MB	Classic - Wireless - Batteryless - Home/Away Master Switch - 2 Module	21128	1/10
AC5708MB	Classic - Wireless - Batteryless - Wake Up/Sleep Scenario Switch - 2 Module	21546	1/10
AC5705MB	Classic - Wireless - Batteryless - 4 Scenario Switch - 2 Module	26910	1/10

Connected Homes-Elite Matt White Mechanism

Connected light Switches

AA52113MW	Elite - Connected Switch - with Neutral - Wired - 1 Module	13636	1/5/20
AA52112MW	Elite - Connected Switch Dimmer - with Neutral - 150 Watts - 1 Module	15660	1/5/50

Connected Curtain/Roller Blind Switches

AA5310MW	Elite - Connected Curtain/Roller Blind Switch - Wired - 1 Module	15866	1/5/20
-----------------	--	-------	--------

Connected Step Fan controller

AA5510MW	Elite - Connected Step Fan Controller - with Neutral - 100W - 2 Module	11988	1/10
-----------------	--	-------	------

Connected Gateway Pack

AC5110MW	Connected Gateway - Wired - 2 Module	21540	1/1/10
-----------------	--------------------------------------	-------	--------

Wireless Control Switch

AA5201MW	Elite - 1 Gang - Wireless Switch - 2 Module	5900	1/5/30
AA5202MW	Elite - 2 Gang - Wireless Switch - 2 Module	6258	1/5/20

Arteor Advance™ IoT

NEW! Connected Homes-Elite Matt White Mechanism

Cat.Nos	Description	MRP* ₹ / Unit	Pack
---------	-------------	------------------	------

Wireless Control Switch

AA5203MW	Elite - 3 Gang - Wireless Switch - 2 Module	7694	1/5/30
-----------------	---	------	--------

Wireless Scenario Control Switch

AA5700MW	Elite - Wireless 4 Scenario Control Switch - 2 Module	10348	1/5/30
AA5701MW	Elite - Home/Away Wireless Master Switch - 2 Module	7926	1/5/30
AA5702MW	Elite - Wake Up/Sleep Wireless Scenario Control Switch - 2 Module	6258	1/5/30

IN Wall Wireless Switch

AA5200MW	Elite - In-Wall - Wireless Control Switch - 1 Module	6774	1/5/20
AA5501MW	Elite - In Wall - Wireless - Fan Control Switch - 1 Module	10744	1/5/20
AA5300MW	Elite - In Wall - Wireless - Curtain/Roller Blind Switch - 1 Module	7816	1/5/20
AA5703MW	Elite - In Wall Wake Up/Sleep Wireless Switch - 1 Module	7926	1/5/20
AA5704MW	Elite - In Wall Home/Away Wireless Switch - 1 Module	7926	1/5/20

Wireless Batteryless Switch

AA5206MW	Elite - Wireless - Batteryless - 1 Gang - Control Switch - 2 Module	26672	1/10
AA5207MW	Elite - Wireless - Batteryless - 2 Gang - Control Switch - 2 Module	30260	1/10
AA5302MW	Elite - Wireless - Batteryless - Curtain/Roller Blind Switch - 2 Module	22168	1/10
AA5707MW	Elite - Wireless - Batteryless - Home/Away Master Switch - 2 Module	22046	1/10
AA5708MW	Elite - Wireless - Batteryless - Wake Up/Sleep Scenario Switch - 2 Module	22482	1/10
AA5705MW	Elite - Wireless - Batteryless - 4 Scenario Switch - 2 Module	28078	1/10

* MRP - Maximum Retail Price Inclusive of all taxes including GST.
Red Cat. Nos - New Products

Bold Cat.Nos are products normally available with Legrand (India) Stockists. Cat.Nos that are not bold - delivery within 4 - 8 weeks from the date of order. Bold packing quantity is our mandatory packing. Orders to be placed by Legrand (India) Stockist in multiples of the same.

Arteor Advance™ IoT

NEW! Connected Homes-Elite Matt Titanium Mechanism



Cat.Nos	Description	MRP* ₹ / Unit	Pack
---------	-------------	------------------	------

Connected Light Switches

AA52113MT	Elite - Connected Switch - with Neutral - Wired - 1 Module	13912	1/5/20
AA52112MT	Elite - Connected Switch Dimmer - with Neutral - 150 Watts - 1 Module	15818	1/5/50

Connected Curtain/Roller Blind Switches

AA5310MT	Elite - Connected Curtain/Roller Blind Switch - Wired - 1 Module	16746	1/5/20
-----------------	--	-------	--------

Connected Step Fan controller

AA5510MT	Elite - Connected Step Fan Controller - with Neutral -100W - 2 Module	13782	1/10
-----------------	---	-------	------

Connected Gateway Pack

AC5110MT	Connected Gateway - Wired - 2 Module	24764	1/1/10
-----------------	--------------------------------------	-------	--------

Wireless Control Switch

AA5201MT	Elite - 1 Gang - Wireless Switch - 2 Module	6786	1/5/30
AA5202MT	Elite - 2 Gang - Wireless Switch - 2 Module	7196	1/5/20
AA5203MT	Elite - 3 Gang - Wireless Switch - 2 Module	8848	1/5/20

Wireless Scenario Control Switch

AA5700MT	Elite - Wireless 4 Scenario Control Switch - 2 Module	11384	1/5/30
AA5701MT	Elite - Home/Away Wireless Master Switch - 2 Module	8374	1/5/30
AA5702MT	Elite - Wake Up/Sleep Wireless Scenario Control Switch - 2 Module	7196	1/5/30

IN Wall Wireless Switch

AA5200MT	Elite - In-Wall - Wireless Control Switch - 1 Module	7224	1/5/20
AA5501MT	Elite - In Wall - Wireless - Fan Control Switch - 1 Module	12356	1/5/20
AA5300MT	Elite - In Wall - Wireless - Curtain/Roller Blind Switch - 1 Module	8250	1/5/20
AA5703MT	Elite - In Wall Wake Up/Sleep Wireless Switch - 1 Module	8374	1/5/20
AA5704MT	Elite - In Wall Home/Away Wireless Switch - 1 Module	8374	1/5/20

* MRP - Maximum Retail Price Inclusive of all taxes including GST.
Red Cat. Nos - New Products

Arteor Advance™ IoT

NEW! Connected Homes-Elite Matt Titanium Mechanism



Cat.Nos	Description	MRP* ₹ / Unit	Pack
---------	-------------	------------------	------

Wireless Batteryless Switch

AA5206MT	Elite - Wireless - Batteryless - 1 Gang - Control Switch - 2 Module	30676	1/10
AA5207MT	Elite - Wireless - Batteryless - 2 Gang - Control Switch - 2 Module	34802	1/10
AA5302MT	Elite - Wireless - Batteryless - Curtain/Roller Blind Switch - 2 Module	25486	1/10
AA5707MT	Elite - Wireless - Batteryless - Home/Away Master Switch - 2 Module	25354	1/10
AA5708MT	Elite - Wireless - Batteryless - Wake Up/Sleep Scenario Switch - 2 Module	25854	1/10
AA5705MT	Elite - Wireless - Batteryless - 4 Scenario Switch - 2 Module	32292	1/10

Connected Homes-Elite Matt Black Mechanism

Connected Light Switches

AA52113MB	Elite - Connected Switch - with Neutral - Wired - 1 Module	13912	1/5/20
AA52112MB	Elite - Connected Switch Dimmer - with Neutral - 150 Watts - 1 Module	15818	1/5/50

Connected Curtain/Roller Blind Switches

AA5310MB	Elite - Connected Curtain/Roller Blind Switch - Wired - 1 Module	16584	1/5/20
-----------------	--	-------	--------

Connected Step Fan controller

AA5510MB	Elite - Connected Step Fan Controller - with Neutral -100W - 2 Module	13782	1/10
-----------------	---	-------	------

Connected Gateway Pack

AC5110MB	Connected Gateway - Wired - 2 Module	24764	1/1/10
-----------------	--------------------------------------	-------	--------

Wireless Control Switch

AA5201MB	Elite- 1 Gang - Wireless Switch - 2 Module	6786	1/5/30
AA5202MB	Elite- 2 Gang - Wireless Switch - 2 Module	7196	1/5/20
AA5203MB	Elite- 3 Gang - Wireless Switch - 2 Module	8848	1/5/20

Bold Cat.Nos are products normally available with Legrand (India) Stockists. Cat.Nos that are not bold - delivery within 4 - 8 weeks from the date of order. Bold packing quantity is our mandatory packing. Orders to be placed by Legrand (India) Stockist in multiples of the same.

Arteor Advance™ IoT

NEW! Connected Homes-Elite Matt Black Mechanism

Cat.Nos	Description	MRP* ₹ / Unit	Pack
Wireless Scenario Control Switch			
AA5700MB	Elite - Wireless 4 Scenario Control Switch - 2 Module	11384	1/5/30
AA5701MB	Elite - Home/Away Wireless Master Switch - 2 Module	8374	1/5/30
AA5702MB	Elite - Wake Up/Sleep Wireless Scenario Control Switch - 2 Module	7196	1/5/30
IN Wall Wireless Switch			
AA5200MB	Elite - In-Wall - Wireless Control Switch - 1 Module	7224	1/5/20
AA5501MB	Elite - In Wall - Wireless - Fan Control Switch - 1 Module	12356	1/5/20
AA5300MB	Elite - In Wall - Wireless - Curtain/Roller Blind Switch - 1 Module	8250	1/5/20
AA5703MB	Elite - In Wall Wake Up/Sleep Wireless Switch - 1 Module	8374	1/5/20
AA5704MB	Elite - In Wall Home/Away Wireless Switch - 1 Module	8374	1/5/20
Wireless Batteryless Switch			
AA5206MB	Elite - Wireless - Batteryless - 1 Gang - Control Switch - 2 Module	30676	1/10
AA5207MB	Elite - Wireless - Batteryless - 2 Gang - Control Switch - 2 Module	34802	1/10

Arteor Advance™ IoT

NEW! Connected Homes-Elite Matt Black Mechanism

Cat.Nos	Description	MRP* ₹ / Unit	Pack
AA5302MB	Elite - Wireless - Batteryless - Curtain/Roller Blind Switch - 2 Module	25486	1/10
AA5707MB	Elite - Wireless - Batteryless - Home/Away Master Switch - 2 Module	25354	1/10
AA5708MB	Elite - Wireless - Batteryless - Wake Up/Sleep Scenario Switch - 2 Module	25854	1/10
AA5705MB	Elite - Wireless - Batteryless - 4 Scenario Switch - 2 Module	32292	1/10
Smart Plug			
6793 90	6A - Smart Mobile Plug	10348	5/20
6793 91	16A - Smart Mobile Plug	11146	5/20
Micro module switch & Accessories			
5742 43	Connected Micro Module Switch - with Neutral - Black	9732	1/0/22
0676 97	Shutter Micromodule	12624	1
0676 94	Wireless Switch - On/Off Module for Mechanical Switch - (Auxiliary) - Black	11810	1
0676 95	Potable Remote - Black	15568	1
White Cover Plate with Support Frame			
AC1200MW	Cover Plate + Frame - 1 Module - Matt White	510	10/100
AC1201MW	Cover Plate + Frame - 2 Module - Matt White	528	10/100

Product Category		Classic Collection			Décor Collection			Pure Metal	
		Matt Titanium (MT)	Matt White (MW)	Matt Black (MB)	Frosted White (FW)	Frosted Black (FB)	Brushed Stainless Steel (BSS)	Midnight Blue (NB)	Solid Aluminium (SA)
Gateway	Classic	Yes	Yes	Yes	Yes	Yes	Yes	Yes	Yes
Wired On/Off Switch Dimmer Switch Curtain Switch	Classic	Yes	Yes	Yes	Yes	Yes	Yes	Yes	Yes
	Elite				Yes	Yes			
Socket Module	Classic	Yes	Yes	Yes	Yes	Yes	Yes	Yes	Yes
Fan Module	Classic	Yes	Yes	Yes	Yes	Yes	Yes	Yes	Yes
	Elite				Yes	Yes			

* MRP - Maximum Retail Price Inclusive of all taxes including GST.
Red Cat. Nos - New Products

Bold Cat.Nos are products normally available with Legrand (India) Stockists. Cat.Nos that are not bold - delivery within 4 - 8 weeks from the date of order. Bold packing quantity is our mandatory packing. Orders to be placed by Legrand (India) Stockist in multiples of the same.

Arteor Advance™ IoT

Classic- Cover Plate with Support Frame

Wireless Batteryless Switch

Product Category		Classic Collection			Décor Collection			Pure Metal	
		Matt Titanium (MT)	Matt White (MW)	Matt Black (MB)	Frosted White (FW)	Frosted Black (FB)	Brushed Stainless Steel (BSS)	Midnight Blue (NB)	Solid Aluminium (SA)
1 Gang Switch	Classic	Yes	Yes	Yes	Yes	Yes	Yes	Yes	Yes
	Elite				Yes	Yes	Yes	Yes	Yes
2 Gang Switch	Classic	Yes	Yes	Yes	Yes	Yes	Yes	Yes	Yes
	Elite				Yes	Yes	Yes	Yes	Yes
Curtain Switch	Classic	Yes	Yes	Yes	Yes	Yes	Yes	Yes	Yes
	Elite				Yes	Yes	Yes	Yes	Yes
Scenario Switch	Classic	Yes	Yes	Yes	Yes	Yes	Yes	Yes	Yes
	Elite				Yes	Yes	Yes	Yes	Yes

Wireless Switches

Product Category		Classic Collection			Décor Collection			Pure Metal	
		Matt Titanium (MT)	Matt White (MW)	Matt Black (MB)	Frosted White (FW)	Frosted Black (FB)	Brushed Stainless Steel (BSS)	Midnight Blue (NB)	Solid Aluminium (SA)
1 Gang Switch	Classic	Yes	Yes	Yes	Yes	Yes	Yes	Yes	Yes
	Elite				Yes	Yes			
2 Gang Switch	Classic	Yes	Yes	Yes	Yes	Yes	Yes	Yes	Yes
	Elite				Yes	Yes			
3 Gang Switch	Classic	Yes	Yes	Yes	Yes	Yes	Yes	Yes	Yes
	Elite				Yes	Yes			
Curtain Switch	Classic	Yes	Yes	Yes	Yes	Yes	Yes	Yes	Yes
	Elite				Yes	Yes			
Scenario Switch	Classic	Yes	Yes	Yes	Yes	Yes	Yes	Yes	Yes
	Elite				Yes	Yes			

Classic- Cover Plate with Support Frame

Cat.Nos	Description	MRP* ₹ / Unit	Pack
White Cover Plate with Support Frame			
AC1202MW	Cover Plate + Frame - 3 Module - Matt White	612	10/100
AC1203MW	Cover Plate + Frame - 4 Module - Matt White	700	5/50
AC1205MW	Cover Plate + Frame - 6 Module - Matt White	964	5/30
AC1207MW	Cover Plate + Frame - 8 Module - Matt White	1140	5/30
AC1208MW	Cover Plate + Frame - 2*4 Module - Matt White	1666	2/20
AC1212MW	Cover Plate + Frame - 9 Module - Matt White	1768	5/30

* MRP - Maximum Retail Price Inclusive of all taxes including GST.
Red Cat. Nos - New Products













Classic- Cover Plate with Support Frame

Cat.Nos	Description	MRP* ₹ / Unit	Pack
White Cover Plate with Support Frame			
AC1210MW	Cover Plate + Frame - 2*6 Module - Matt White	2216	2/16
AC1213MW	Cover Plate + Frame - 2*8 Module - Matt White	2436	2/16
AC1211MW	Cover Plate + Frame - 3*6 Module - Matt White	2872	2/12
Matt Black Cover Plate with Support Frame			
AC1200MB	Cover Plate + Frame - 1 Module - Matt Black	614	10/100
AC1201MB	Cover Plate + Frame - 2 Module - Matt Black	648	10/100
AC1202MB	Cover Plate + Frame - 3 Module - Matt Black	686	10/100
AC1203MB	Cover Plate + Frame - 4 Module - Matt Black	778	5/50

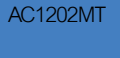
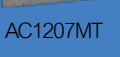
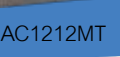
Bold Cat.Nos are products normally available with Legrand (India) Stockists. Cat.Nos that are not bold - delivery within 4 - 8 weeks from the date of order. Bold packing quantity is our mandatory packing. Orders to be placed by Legrand (India) Stockist in multiples of the same.

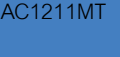
Arteor Advance™ IoT

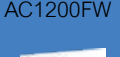
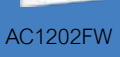











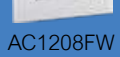

NEW! Classic- Cover Plate with Support Frame

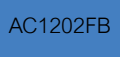
Cat.Nos	Description	MRP* ₹ / Unit	Pack
Matt Black Cover Plate with Support Frame			
 AC1207MB	Cover Plate + Frame - 6 Module - Matt Black	1330	5/30
 AC1207MB	Cover Plate + Frame - 8 Module - Matt Black	1476	5/30
 AC1208MB	Cover Plate + Frame - 2*4 Module - Matt Black	1872	2/20
 AC1212MB	Cover Plate + Frame - 9 Module - Matt Black	1986	5/30
 AC1210MB	Cover Plate + Frame - 2*6 Module - Matt Black	2430	2/16
 AC1213MB	Cover Plate + Frame - 2*8 Module - Matt Black	2760	2/16
 AC1211MB	Cover Plate + Frame - 3*6 Module - Matt Black	3226	2/12
Matt Titanium Cover Plate with Support Frame			
 AC1200MT	Cover Plate + Frame - 1 Module - Matt Titanium	614	10/100
 AC1202MT	Cover Plate + Frame - 2 Module - Matt Titanium	648	10/100
 AC1202MT	Cover Plate + Frame - 3 Module - Matt Titanium	686	10/100
 AC1203MT	Cover Plate + Frame - 4 Module - Matt Titanium	778	5/50
 AC1205MT	Cover Plate + Frame - 6 Module - Matt Titanium	1330	5/30
 AC1207MT	Cover Plate + Frame - 8 Module - Matt Titanium	1476	5/30
 AC1208MT	Cover Plate + Frame - 2*4 Module - Matt Titanium	1872	2/20
 AC1212MT	Cover Plate + Frame - 9 Module - Matt Titanium	1986	5/30
 AC1210MT	Cover Plate + Frame - 2*6 Module - Matt Titanium	2430	2/16
 AC1213MT	Cover Plate + Frame - 2*8 Module - Matt Titanium	2760	2/16
 AC1211MT	Cover Plate + Frame - 3*6 Module - Matt Titanium	3226	2/12
Frosted White Cover Plate with Support Frame			
AC1200FW	Cover Plate + Frame - 1 Module - Frosted White	788	1/5/30
AC1201FW	Cover Plate + Frame - 2 Module - Frosted White	842	1/5/30
AC1202FW	Cover Plate + Frame - 3 Module - Frosted White	902	1/20

* MRP - Maximum Retail Price Inclusive of all taxes including GST.
Red Cat. Nos - New Products

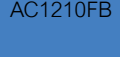
Arteor Advance™ IoT

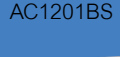
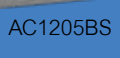
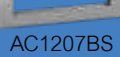
NEW! Classic- Cover Plate with Support Frame

Cat.Nos	Description	MRP* ₹ / Unit	Pack
Frosted White Cover Plate with Support Frame			
 AC1203FW	Cover Plate + Frame - 4 Module - Frosted White	960	1/20
 AC1205FW	Cover Plate + Frame - 6 Module - Frosted White	1746	1/5/30
 AC1207FW	Cover Plate + Frame - 8 Module - Frosted White	1922	1/5/30
 AC1208FW	Cover Plate + Frame - 2*4 Module - Frosted White	2482	1/10
 AC1210FW	Cover Plate + Frame - 2*6 Module - Frosted White	2998	1/16
Frosted Black Cover Plate with Support Frame			
 AC1200FB	Cover Plate + Frame - 1 Module - Frosted Black	788	1/5/30
 AC1201FB	Cover Plate + Frame - 2 Module - Frosted Black	842	1/5/30
 AC1202FB	Cover Plate + Frame - 3 Module - Frosted Black	902	1/20
 AC1203FB	Cover Plate + Frame - 4 Module - Frosted Black	960	1/20
 AC1205FB	Cover Plate + Frame - 6 Module - Frosted Black	1746	1/5/30
 AC1207FB	Cover Plate + Frame - 8 Module - Frosted Black	1922	1/5/30
 AC1208FB	Cover Plate + Frame - 2*4 Module - Frosted Black	2482	1/10
 AC1210FB	Cover Plate + Frame - 2*6 Module - Frosted Black	2998	1/16
Brushed Stainless Steel Cover Plate with Support Frame			
 AC1200BS	Cover Plate + Frame - 1 Module - Brushed Stainless Steel	3596	1/5/30
 AC1201BS	Cover Plate + Frame - 2 Module - Brushed Stainless Steel	3844	1/5/30
 AC1202BS	Cover Plate + Frame - 3 Module - Brushed Stainless Steel	4134	1/20
 AC1203BS	Cover Plate + Frame - 4 Module - Brushed Stainless Steel	4388	1/20
 AC1205BS	Cover Plate + Frame - 6 Module - Brushed Stainless Steel	7986	1/5/30
AC1207BS	Cover Plate + Frame - 8 Module - Brushed Stainless Steel	8782	1/5/30

Bold Cat.Nos are products normally available with Legrand (India) Stockists. Cat.Nos that are not bold - delivery within 4 - 8 weeks from the date of order. Bold packing quantity is our mandatory packing. Orders to be placed by Legrand (India) Stockist in multiples of the same.

Arteor Advance™ IoT

NEW! Elite- Cover Plate with Support Frame

Cat.Nos	Description	MRP* ₹ / Unit	Pack
Brushed Stainless Steel Cover Plate with Support Frame			
AC1208BS	Cover Plate + Frame - 2*4 Module - Brushed Stainless Steel	11100	1/10
AC1210BS	Cover Plate + Frame - 2*6 Module - Brushed Stainless Steel	13682	1/16

Solid Aluminium Cover Plate with Support Frame

AC1200SA	Cover Plate + Frame - 1 Module - Solid Aluminium	5134	1/5/30
AC1201SA	Cover Plate + Frame - 2 Module - Solid Aluminium	5494	1/5/30
AC1202SA	Cover Plate + Frame - 3 Module - Solid Aluminium	5908	1/20
AC1203SA	Cover Plate + Frame - 4 Module - Solid Aluminium	6270	1/20
AC1205SA	Cover Plate + Frame - 6 Module - Solid Aluminium	11408	1/5/30
AC1207SA	Cover Plate + Frame - 8 Module - Solid Aluminium	12544	1/5/30
AC1208SA	Cover Plate + Frame - 2*4 Module - Solid Aluminium	15856	1/10
AC1210SA	Cover Plate + Frame - 2*6 Module - Solid Aluminium	19546	1/16

Midnight Blue Cover Plate with Support Frame

AC1200NB	Cover Plate + Frame - 1 Module - Midnight Blue	5134	1/5/30
AC1201NB	Cover Plate + Frame - 2 Module - Midnight Blue	5494	1/5/30
AC1202NB	Cover Plate + Frame - 3 Module - Midnight Blue	5908	1/20
AC1203NB	Cover Plate + Frame - 4 Module - Midnight Blue	6270	1/20
AC1205NB	Cover Plate + Frame - 6 Module - Midnight Blue	11408	1/5/30
AC1207NB	Cover Plate + Frame - 8 Module - Midnight Blue	12544	1/5/30
AC1208NB	Cover Plate + Frame - 2*4 Module - Midnight Blue	15856	1/10
AC1210NB	Cover Plate + Frame - 2*6 Module - Midnight Blue	19546	1/16

Arteor Advance™ IoT

NEW! Elite- Cover Plate with Support Frame

Cat.Nos	Description	MRP* ₹ / Unit	Pack
Round Plates with Support Frame			
AA1202MW	Cover Plate + Frame - 2 Module - Round - Matt White	658	10/100
AA1202MB	Cover Plate + Frame - 2 Module - Round - Matt Black	808	10/100
AA1202MT	Cover Plate + Frame - 2 Module - Round - Matt Titanium	808	10/100

Frosted White Cover Plate with Support Frame

AA1200FW	Cover Plate + Frame - 1 Module - 1 x Elite - Frosted White	984	1/5/30
AA1201FW	Cover Plate + Frame - 2 Module - 2 x Elite - Frosted White	1054	1/5/30
AA1202FW	Cover Plate + Frame - 2 Module - Round - Frosted White	1054	1/5/30
AA1203FW	Cover Plate + Frame - 3 Module - 3 x Elite - Frosted White	1130	1/20
AA1204FW**	Cover Plate + Frame - 4 Module - 4 x Elite - Frosted White	1248	1/5/30

Frosted Black Cover Plate with Support Frame

AA1200FB	Cover Plate + Frame - 1 Module - 1 x Elite - Frosted Black	984	1/5/30
AA1201FB	Cover Plate + Frame - 2 Module - 2 x Elite - Frosted Black	1054	1/5/30
AA1202FB	Cover Plate + Frame - 2 Module - Round - Frosted Black	1054	1/5/30
AA1203FB	Cover Plate + Frame - 3 Module - 3 x Elite - Frosted Black	1130	1/20
AA1204FB**	Cover Plate + Frame - 4 Module - 4 x Elite - Frosted Black	1248	1/5/30

Brushed Stainless Steel Cover Plate with Support Frame

AA1200BS	Cover Plate + Frame - 1 Module - 1 x Elite - Brushed Stainless Steel	4492	1/5/30
AA1201BS	Cover Plate + Frame - 2 Module - 2 x Elite - Brushed Stainless Steel	4806	1/5/30

Bold Cat.Nos are products normally available with Legrand (India) Stockists. **Cat.Nos** that are not bold - delivery within 4 - 8 weeks from the date of order. **Bold packing quantity** is our mandatory packing. Orders to be placed by Legrand (India) Stockist in multiples of the same.

* MRP - Maximum Retail Price Inclusive of all taxes including GST.
**Lead Time : 8 - 10 weeks after order booking
Red Cat. Nos - New Products

NEW!

Cat.Nos	Description	MRP* ₹ / Unit	Pack
Brushed Stainless Steel Cover Plate with Support Frame			
AA1202BS	Cover Plate + Frame - 2 Module - Round - Brushed Stainless Steel	4806	1/5/30
AA1203BS	Cover Plate + Frame - 3 Module - 3 x Elite - Brushed Stainless Steel	5170	1/20

Solid Aluminium Cover Plate with Support Frame

AA1200SA	Cover Plate + Frame - 1 Module - 1 x Elite - Solid Aluminium	6418	1/5/30
AA1201SA	Cover Plate + Frame - 2 Module - 2 x Elite - Solid Aluminium	6870	1/5/30
AA1202SA	Cover Plate + Frame - 2 Module - Round - Solid Aluminium	6870	1/5/30
AA1203SA	Cover Plate + Frame - 3 Module - 3 x Elite - Solid Aluminium	7386	1/20
AA1204SA**	Cover Plate + Frame - 4 Module - 4 x Elite - Solid Aluminium	8150	1/5/30

Elite Midnight Blue Cover Plate with Support Frame

AA1200NB	Cover Plate + Frame - 1 Module - 1 x Elite - Midnight Blue	6418	1/5/30
AA1201NB	Cover Plate + Frame - 2 Module - 2 x Elite - Midnight Blue	6870	1/5/30
AA1202NB	Cover Plate + Frame - 2 Module - Round - Midnight Blue	6870	1/5/30
AA1203NB	Cover Plate + Frame - 3 Module - 3 x Elite - Midnight Blue	7386	1/20
AA1204NB**	Cover Plate + Frame - 4 Module - 4 x Elite - Midnight Blue	8150	1/5/30

Elite Frosted White Cover Plate with Support Frame

AB1208FW	Cover Plate + Frame - 4 Module - 2 x Classic + 2 x Elite - Frosted White	1248	1/20
AB1203FW	Cover Plate + Frame - 6 Module - 3 x Classic + 2 x Elite - Frosted White	2270	1/5/30

NEW!

Cat.Nos	Description	MRP* ₹ / Unit	Pack
Elite Frosted White Cover Plate with Support Frame			
AB1205FW	Cover Plate + Frame - 6 Module - 4 x Classic + 1 x Elite - Frosted White	2270	1/5/30
AB1202FW	Cover Plate + Frame - 6 Module - 3 x Classic + Round - Frosted White	2270	1/5/30
AB1207FW	Cover Plate + Frame - 8 Module - 5 x Classic + Round - Frosted White	2498	1/5/30

Elite Frosted Black Cover Plate with Support Frame

AB1208FB	Cover Plate + Frame - 4 Module - 2 x Classic + 2 x Elite - Frosted Black	1248	1/20
AB1203FB	Cover Plate + Frame - 6 Module - 3 x Classic + 2 x Elite - Frosted Black	2270	1/5/30
AB1205FB	Cover Plate + Frame - 6 Module - 4 x Classic + 1 x Elite - Frosted Black	2270	1/5/30
AB1202FB	Cover Plate + Frame - 6 Module - 3 x Classic + Round - Frosted Black	2270	1/5/30
AB1207FB	Cover Plate + Frame - 8 Module - 5 x Classic + Round - Frosted Black	2498	1/5/30

Elite Brushed Stainless Steel Cover Plate with Support Frame

AA1200BS	Cover Plate + Frame - 1 Module - 1 x Elite - Brushed Stainless Steel	5704	1/5/30
AA1201BS	Cover Plate + Frame - 2 Module - 2 x Elite - Brushed Stainless Steel	10382	1/5/30
AA1202BS	Cover Plate + Frame - 2 Module - Round - Brushed Stainless Steel	10382	1/5/30
AA1203BS	Cover Plate + Frame - 3 Module - 3 x Elite - Brushed Stainless Steel	10382	1/20
AA1204BS	Cover Plate + Frame - 4 Module - 4 x Elite - Brushed Stainless Steel	11418	1/5/30

* MRP - Maximum Retail Price Inclusive of all taxes including GST.

**Lead Time : 8 - 10 weeks after order booking

Red Cat. Nos - New Products

Bold Cat.Nos are products normally available with Legrand (India) Stockists. Cat.Nos that are not bold - delivery within 4 - 8 weeks from the date of order. Bold packing quantity is our mandatory packing. Orders to be placed by Legrand (India) Stockist in multiples of the same.

Arteor Advance™ IoT

NEW! Accessories- Metal Flush Boxes

Cat.Nos	Description	MRP* ₹ / Unit	Pack
---------	-------------	------------------	------

Elite Solid Aluminium Cover Plate with Support Frame

AB1208SA	Cover Plate + Frame - 4 Module - 2 x Classic + 2 x Elite - Solid Aluminium	8150	1/20
AB1203SA	Cover Plate + Frame - 6 Module - 3 x Classic + 2 x Elite - Solid Aluminium	14832	1/5/30
AB1205SA	Cover Plate + Frame - 6 Module - 4 x Classic + 1 x Elite - Solid Aluminium	14832	1/5/30
AB1202SA	Cover Plate + Frame - 6 Module - 3 x Classic + Round - Solid Aluminium	14832	1/5/30
AB1207SA	Cover Plate + Frame - 8 Module - 5 x Classic + Round - Solid Aluminium	16306	1/5/30

Elite Midnight Blue Cover Plate with Support Frame

AB1208NB	Cover Plate + Frame - 4 Module - 2 x Classic + 2 x Elite - Midnight Blue	8150	1/20
AB1203NB	Cover Plate + Frame - 6 Module - 3 x Classic + 2 x Elite - Midnight Blue	14832	1/5/30
AB1205NB	Cover Plate + Frame - 6 Module - 4 x Classic + 1 x Elite - Midnight Blue	14832	1/5/30
AB1202NB	Cover Plate + Frame - 6 Module - 3 x Classic + Round - Midnight Blue	14832	1/5/30
AB1207NB	Cover Plate + Frame - 8 Module - 5 x Classic + Round - Midnight Blue	16306	1/5/30

Accessory

0648 71	Pack of 3*4 Extra Removable Stickers for Fixing A Wireless Control	806	1/25
----------------	--	-----	------

Metal Flush Boxes

6890 07	Metal Flush Box - 1/2 Module	170	40
6890 08	Metal Flush Box - 3 Module	170	40
6890 09	Metal Flush Box - 4 Module	226	40

* MRP - Maximum Retail Price Inclusive of all taxes including GST.
Red Cat. Nos - New Products

Arteor Advance™ IoT

NEW! Accessories- Metal Flush Boxes

Cat.Nos	Description	MRP* ₹ / Unit	Pack
---------	-------------	------------------	------

Metal Flush Boxes

6890 10	Metal Flush Box - 6 Module	358	40
6890 42	Metal Flush Box - 8 Module	416	40
6890 31	Metal Flush Box - 4*2 Module	414	20
6890 29	Metal Flush Box - 9 Module	490	20
6890 11	Metal Flush Box - 12 Module	624	10
6890 13	Metal Flush Box - 16 Module	720	10
6890 12	Metal Flush Box - 18 Module	788	10

Bold Cat.Nos are products normally available with Legrand (India) Stockists. Cat.Nos that are not bold - delivery within 4 - 8 weeks from the date of order. Bold packing quantity is our mandatory packing. Orders to be placed by Legrand (India) Stockist in multiples of the same.

ARTEOR™

Versatile Wiring Devices for Global Projects



Arteor™ is a modular wiring device range designed to meet the needs of residential, commercial, and hospitality projects worldwide. Combining ergonomic design, premium finishes, and advanced control options, it supports everything from standard electrical installations to connected IoT and BUS-based automation systems.

Features

- Ergonomic round and square rocker designs available in refined finishes
- Extensive finish palette with over 16 colours
- Extensive mechanism range with switches, dimmers, USB chargers, and data outlets
- Smart-ready solutions supporting automation, hotel controls, and scenario-based switching

Benefits

- Supports global projects with compliance to IEC & BS
- Enhances interiors with premium materials and contemporary design options
- Supports modern connectivity needs with integrated charging and data solutions
- Enables scalable control from simple wiring setups to advanced automation systems



Scan to know more about the product.





Round rocker White



Round rocker Magnesium



Round rocker Champagne



Square rocker White

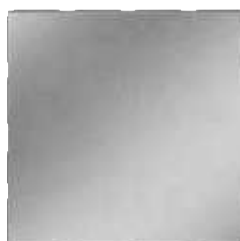

Square rocker Magnesium



Square rocker Champagne



ARTEOR™

Versatility & Modularity for Unrivalled Flexibility

Arteor™ is a modular range offering maximum flexibility in terms of installation and configuration.

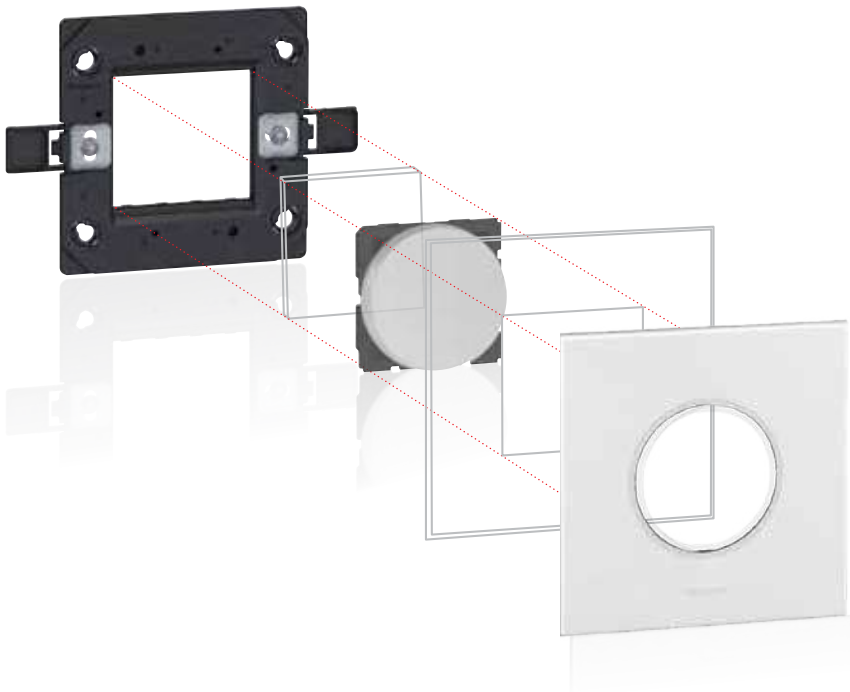

Features that set ARTEOR™ apart



- ① Finger-proof terminals for IP 20 protection against accidental contact.
- ② Captive "never to loose" screws

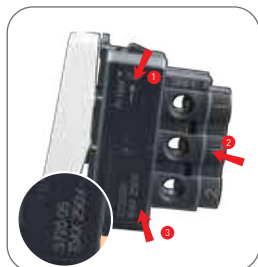

- ① Tunnel terminals preventing screwdrivers from slipping.
- ② Laser marking on mechanisms. Arrow showing the correct orientation of the mechanism.
- ③ The latest IS 3854 : 2023.



Sockets with ISI* mark, conforming to IS 1293. Fan regulator with ISI* mark, conforming to IS 11037.



Fully shrouded internal mechanism under the rocker preventing visibility of sparks.



- ① Stripping templates on sockets for stripping off exact length of insulation.



- ① Sockets are shuttered for child's safety against electric shocks.



Possibility of weather proofing mechanisms using Plexo IP 55 and IP 66 boxes.



For switches with LED lamps, life of LED is 50000 burning hours. Consumes power (0.76W) next to NIL.

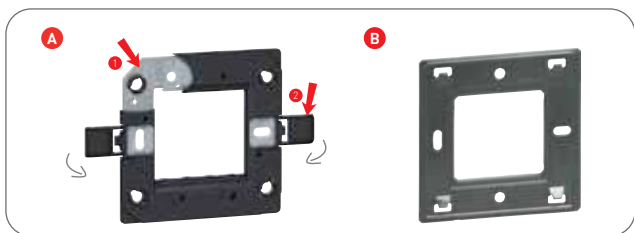

A. For all high end plates Metal frame providing solid support to base. Bi-material frame - electrical safety IP20. Screw caps can be closed once the support frame is installed, ensuring total insulation.



2x2 way switch - 3 controls possible in 2 module plate. In round and square design possible.



Mechanisms compatible with DLP trunking systems, columns, floor boxes and VDI installations.

ARTEOR™

The Ideal Solution, Always & Everywhere

Its versatility makes Arteor™ the ideal choice for every kind of project, anywhere in the world at any installation level. Arteor™ suits any requirement in terms of design and function for every kind of building, from residential to commercial.



TV socket



Skirting light

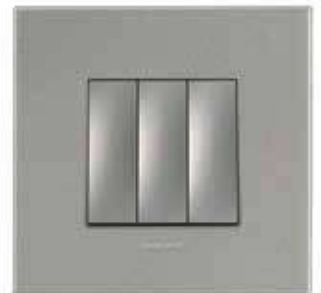

1-way switch - 3 gang



USB Charger
Type C+C - 65W





6AX switch*



Skirting light



USB charger
Type C+C - 30W



Triple RCA socket



Time delay switch

* Switch compatible with LED light

Modern Home



ARTEOR™

Office & Hotel Solutions

Offices and collective spaces require specific solutions and maximum flexibility: lighting adapted to each situation (meeting, conference, etc.), access security, comprehensive multimedia connections. The Arteor™ range meets all these expectations with perfect adaptability.



Automatic switch



6A 1 way switch



USB socket



Preterminated HDMI sockets



Female HD15 + Jack



USB Charger
Type C - 45W



From hotel room door to the beside table, Arteor™ provides all the solutions for the specific need of today's hotel industry. Comfort that extends to the hotel's communal areas, whether dedicated to the relaxation or work. The multitude of small details, gives the comfort feeling of being at home to the traveller.



Data sockets



4-Scenario touch control



S-Video socket



Keycard switch



External unit



Desk and Entrance Light



Bed light & curtain switch



Internal Unit



ARTEOR™

A Rich Choice of Finishes

NEUTRAL

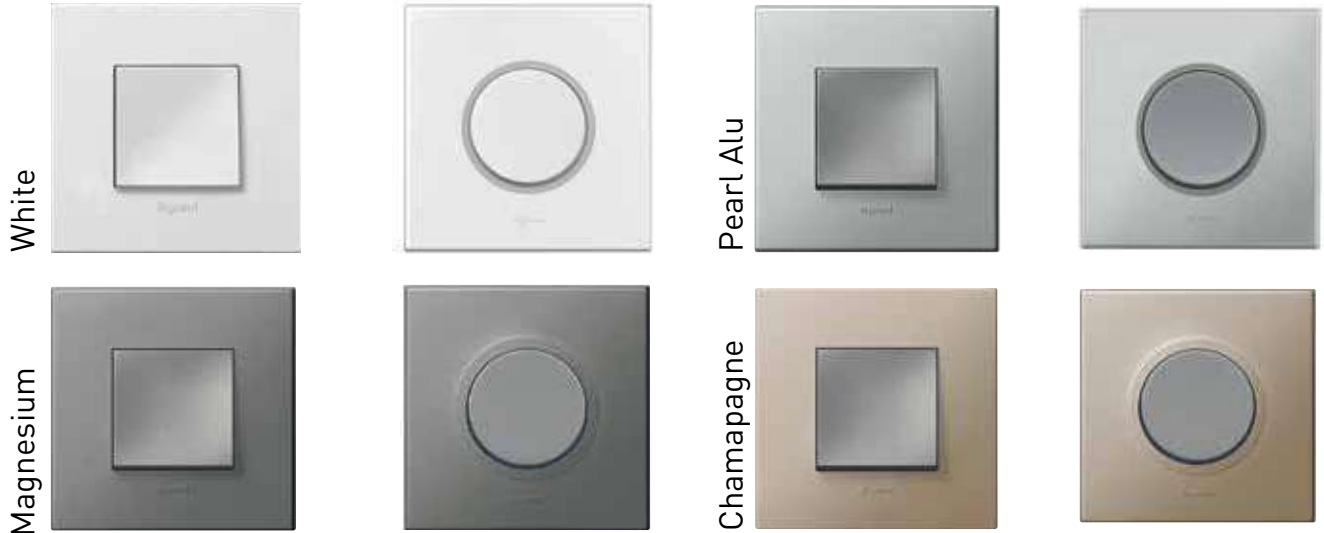

MIRROR



GRAPHIC

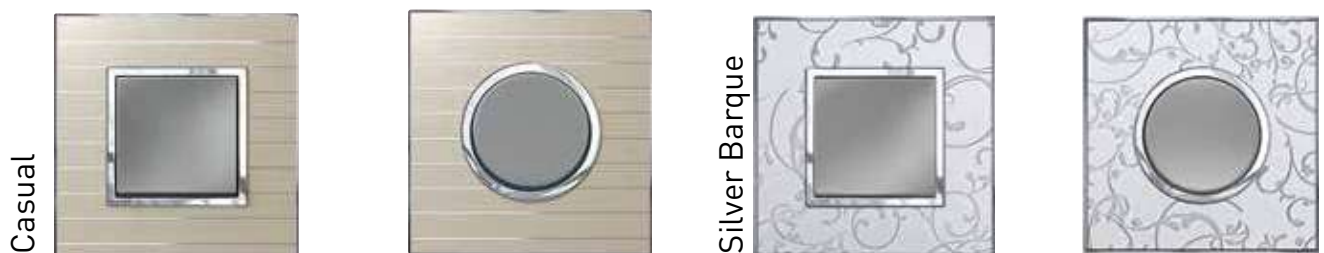

METAL

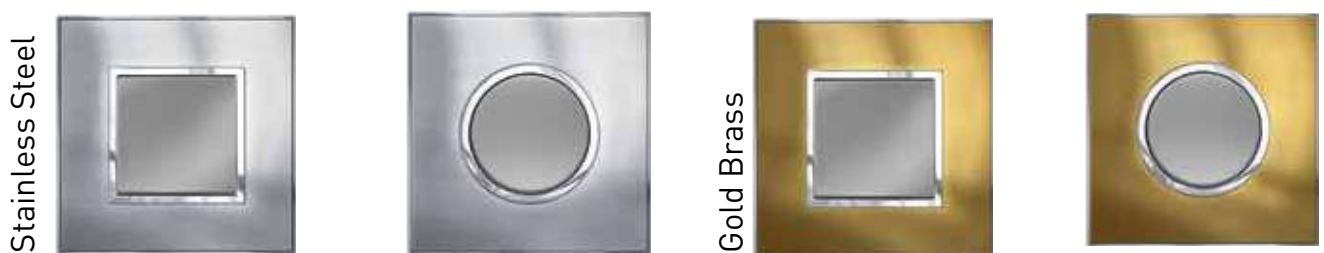

Graphite



Dark Bronze



Green Apple



Dark Barque



WOOD

Grey Oak



SIGNATURE

Cube



ARTEOR™

MyHOME

Elegant and Intuitive Home Automation

Arteor™ MyHOME offers elegant home automation that combines beautiful design with simple touch control for lighting, blinds, HVAC, and more through intuitive touchscreens and smartphone apps.

Features

- Full-range touchscreen interface for home control
- Smartphone app with dedicated icons for lights, temperature, blinds, and scenarios
- Seamless integration across electrical, wiring, and building infrastructure
- Versatile design suitable for rural, industrial, and digital environments

Benefits

- Simplifies home management with intuitive touch and mobile control
- Enhances aesthetics while providing comprehensive automation
- Reduces complexity through unified interface for all systems
- Adapts to diverse architectural and lifestyle settings

Scan to know more about the product.



THE FINISHING TOUCH



Cat.Nos	Description	MRP* ₹ / Unit	Pack
---------	-------------	------------------	------

Switches – 6A - 230V AC

5734 00	6A - Switch - SP - 1 Way - 1 Module	232	1/20/200
5734 01	6A - Switch - SP - 1 Way - with Indicator - 1 Module	432	1/20/200
5734 02	6A - Switch - SP - 2 Way - 1 Module	382	1/20/200
5734 03	6A - Switch - SP - 2 Way - with Indicator - 1 Module	540	1/20/200

Switches – 10A - 230V AC

5734 50	10A - Switch - SP - 1 Way - 2 Module	456	1/10/100
5734 51	10A - Switch - SP - 2 Way - 2 Module	538	1/10/100
5720 37	10A - Switch - SP - 2 Way - with Indicator & Label Holder - 2 Module	2552	5/50
5720 38	10A - Intermediate Switch - 230V AC - 2 Module	3054	10/100

Switches – 20A - 230V AC

5734 10	20A - Switch - SP - 1 Way - 1 Module	520	1/20/200
5734 52	20A - Switch - SP - 1 Way - 2 Module	620	1/10/100
5720 63	20A - Switch - SP - 1 Way - with Indicator - 1 Module	536	1/20/200
5734 11	20A - Switch - SP - 2 Way - with Indicator - 1 Module	750	1/20/200
5720 42	20A - Switch - SP - 2 Way - with Indicator - 2 Module	816	10/100
5720 43	20A - Switch - 3 Gang - 1 Way - 2 Module	1464	10/100
5720 44	20A - Switch - 3 Gang - 2*2 Way + 1*1 Way - 2 Module	1604	10/100
5734 54	20A - Switch - DP - 1 Way - with Indicator - 2 Module	1154	1/10/100
5720 49	20A - Switch - DP - 1 Way - with Indicator & Water Heater Marking - 2 Module	1210	10/100

Accessory for Switch with Indicator

5738 06	LED for Switch - with Indicator (Blue)	94	5/50
---------	--	----	------

Switches – 25A - 230V AC

5734 17	25A - Switch - 1 Way - with Indicator - 1 Module	696	1/20/200
---------	--	-----	----------

Cat.Nos	Description	MRP* ₹ / Unit	Pack
---------	-------------	------------------	------

Switches – 32A / 40A - 230V AC

5734 12	32A - Switch - DP - 1 Way - with Indicator - 2 Module	1646	10/100
5735 30	40A - Switch - DP - 1 Way - with Indicator - fits on 1/2 Module Box	1896	1/5/20

Push Button – 6A - 230V AC

5734 13	6A - Bell Push - SP - 1 Way - 1 Module	418	1/20/200
5734 59	6A - Bell Push - SP - 1 Way - 2 Module	590	1/10/100
5734 04	6A - Push Button - SP - 1 Way - 1 Module	444	1/20/200
5734 05	6A - Push Button - SP - 1 Way - with Indicator - 1 Module	560	1/20/200
5734 14	6A - Bell Push - SP - 1 Way - with Indicator - 1 Module	556	1/20/200
5734 60	6A - Bell Push - SP - 1 Way - with Indicator - 2 Module	792	1/10/100

Electric Roller Blinds Control

5722 20	Double Switch for Electric Shutter - 2 Module	1024	1/10/100
---------	---	------	----------

Dimmers & Fan Regulators

5734 62	Light Dimmer - 60 to 400 Watts - 2 Module	1720	1/10/100
5734 16	Fan Step Regulator - 100 Watts - ISI - 1 Module	1416	1/5/50
5734 63	Fan Step Regulator - 100 Watts - ISI - 2 Module	1746	1/10/100
5734 69	Fan Step Regulator - 120 Watts - ISI - 2 Module (for 48 & 56" Fans)	1868	1/10/100
5734 68	Fan Step Regulator - for Energy Saving Fans - 2 Module	1864	1/10/100
5736 53	Fan Regulator - 8 Steps - 100 Watts - ISI - 2 Module	1666	1/10/100

* MRP - Maximum Retail Price Inclusive of all taxes including GST.

Bold Cat.Nos are products normally available with Legrand (India) Stockists. Cat.Nos that are not bold - delivery within 4 - 8 weeks from the date of order. **Bold packing quantity** is our mandatory packing. Orders to be placed by Legrand (India) Stockist in multiples of the same.

Arteor™ Square White Mechanism

Cat.Nos	Description	MRP* ₹ / Unit	Pack
---------	-------------	------------------	------

Indian Standard Sockets

5734 24	6A - Socket - with Shutter - 3 Pin - ISI - 2 Module	356	1/20/200
5734 71	6/16A - Socket - with Shutter - 3 Pin - Indian - ISI - 2 Module	722	1/10/100
5734 67	6/16A - Socket - with Shutter - 3 Pin - Indian - ISI - 3 Module	864	1/5/50
5735 10	16A - Socket Shutter with Switch - 3 Pin - 2P+E - Indian - 3 Module	2018	5/50

Energy Plugs

5738 86	6A - Plug	170	1/10/100
5738 88	16A - Plug	228	1/10/100

USB Chargers (IS13252 (Part 1) / IEC 60950-1)

5734 41	USB Charger - 1500mA - Type A - 1 Module	2722	1/5/50
5716 80	USB Charger - 3000mA/15 Watts - Type A - 1 Module	3206	1/10/150
5716 84	USB Charger - 3000mA/15 Watts - Type A + A - 1 Module	3626	1/10/150
5716 88	USB Charger - 3000mA/15 Watts - Type A + C - 1 Module	4040	1/10/150
5716 92	USB Charger - 3000mA/15 Watts - Type C + C - 1 Module	4526	1/10/150
5716 96	USB Charger - Power Delivery - 20 Watts - Type C - 1 Module	6194	1/10/150
5734 81	USB Charger - Power Delivery - 30 Watts - Type C + C - 2 Module	9268	1/20
5754 81	USB Charger - Power Delivery - 45 Watts - Type C - 2 Module	11962	1/20
NEW! 5754 94	USB Charger - Power Delivery - 65 Watts - Type C + C - 3 Module	14650	1/20

Data & Voice

5734 27	Telephone Socket - Double RJ11 - 1 Module	642	1/20/200
5734 26	Telephone Socket - RJ11 - with Shutter - 1 Module	374	1/20/200
5734 29	Information Socket - RJ45 - Cat 5E - UTP - 1 Module	739	1/20/200
5734 75	Information Socket - RJ45 - Cat 5E - UTP - 2 Module	788	1/10/100
5734 28	Information Socket - RJ45 - Cat 6 - UTP - 1 Module	1127	1/20/200
5734 74	Information Socket - RJ45 - Cat 6 - UTP - 2 Module	1184	1/10/100

* MRP - Maximum Retail Price Inclusive of all taxes including GST.

^Coming Soon.

Red Cat. Nos - New Products

Arteor™ Square White Mechanism

Cat.Nos	Description	MRP* ₹ / Unit	Pack
---------	-------------	------------------	------

Tv Sockets

5734 25	TV Co - axial Socket - 1 Module	390	1/20/200
---------	---------------------------------	-----	----------

Electronic Chime

5734 43	Bell Ding Dong - 230V - 2 Module	686	1/10/100
---------	----------------------------------	-----	----------

Buzzer

5734 42	Buzzer - 230V - 1 Module	1822	1/20/200
---------	--------------------------	------	----------

Bell Call Indicator & Register - 6A - 230V AC

5734 15	6A - Bell Call Indicator - SP - with Register - 1 Way - 1 Module	2646	1/20/200
5736 06	Set of Labels for Bell Call Indicator	704	1/5/50

Skirting Light

5734 64	Skirting Light - with LED - 230V - 3 Module	1420	1/10/100
5722 26	Skirting Light - with Detector (LED) - 230V - 2 Module	18570	1/20

Lighting

5724 53	Over Door Light Unit (Red) - 2 Module	798	10/100
5722 23	Over Door Light Unit (White) - 2 Module	656	10/100
NEW! 5735 97^	Indicator Unit - with Transparent LED - 1 Module	732	10/100

Hospitality Function

Hotel "DND & MMR" Functions

5734 61	External DND & MMR Control Unit - with Bell Push - 2 Module	2840	1/5/50
5734 58	Internal DND & MMR Control Unit - 2 Module	2036	1/10/100

Hotel Keycard Switch

5722 44	16A - Key Card Switch - 230V - 2 Module	7752	1/10
5722 59	Key Fob for Key Card Switch	2114	10/50

Shaver Socket

5721 53	Shaver Socket - 230V/120 - 230V - with Earth Connector	8056	1
---------	--	------	---

Bold Cat.Nos are products normally available with Legrand (India) Stockists. Cat.Nos that are not bold - delivery within 4 - 8 weeks from the date of order. Bold packing quantity is our mandatory packing. Orders to be placed by Legrand (India) Stockist in multiples of the same.

Arteor™

Square White Mechanism

Cat.Nos	Description	MRP* ₹ / Unit	Pack
---------	-------------	------------------	------

Time Switch

5720 55	Time Delay Switch - 2 Module	9554	1/20
---------	------------------------------	------	------

Audio-Video Sockets

5722 72	Double RCA Socket (Audio) - 1 Module	6074	1/20
5722 73	Triple RCA Socket (Audio & Video) - 1 Module	5448	1/20
5722 74	Female 3.5mm Jack - 1 Module	6043	1/20
5722 76	Female BNC 75 Jack - 1 Module	6375	1/20
5722 83	Female XLR Jack - 2 Module	9372	1/20
5720 97	Preterminated Sockets Female Hd15 - 1 Module	8413	1
5720 96	Preterminated HDMI Socket - 1.4 - 1 Module	9980	1
5722 84	Line Dying Down - 100V (25 - 30W) - 2 Module	15612	1
5722 77	Male XLR Jack - 2 Module	8575	1/20
5722 78	Female 3.5mm Jack - Solder - 1 Module	4985	1/20
5722 75	USB Socket - 1 Module	4695	1/20
5722 88	Female HD15 + Jack 3.5mm - 2 Module	6773	1/20

Cable Outlet

5734 80	45A - Cable Outlet - 2 Module	1560	5/50
5734 33	Cord Outlet - with 8mm Diameter - 1 Module	494	1/20/200
5734 79	Standard Cord Outlet - 2 Module	714	10/100

Blanking Plate

5734 49	Blanking Plate - 1 Module	72	1/40/400
5723 44	Blanking Plate - 2 Module	108	1/10/100
5758 10	Blanking Plate with Frame - 2 Module	656	10/100

Mounting Accessories for Panel

5760 15	Panel Mounting Support - 1 Module	414	1/10/100
5760 16	Panel Mounting Support - 2 Module	440	1/10/100
5760 50	DIN Rail Support - 2 Module	522	1/10/100

Square - Magnesium Mechanism

Switches - 6A - 230V AC

5736 00	6A - Switch - SP - 1 Way - 1 Module	272	1/20/200
5736 01	6A - Switch - SP - 1 Way - with Indicator - 1 Module	492	1/20/200

Arteor™

Square Magnesium Mechanism

Cat.Nos	Description	MRP* ₹ / Unit	Pack
---------	-------------	------------------	------

Switches - 6A - 230V AC

5736 02	6A - Switch - SP - 2 Way - 1 Module	444	1/20/200
5736 03	6A - Switch - SP - 2 Way - with Indicator - 1 Module	630	1/20/200

Switches - 10A - 230V AC

5736 50	10A - Switch - SP - 1 Way - 2 Module	488	1/10/100
5736 51	10A - Switch - SP - 2 Way - 2 Module	574	1/10/100
5725 37	10A - Switch - SP - 2 Way - with Indicator & Label Holder - 2 Module	2876	1/5/50
5725 38	10A - Intermediate Switch - 230V AC - 2 Module	3516	1/10/100

Switches - 20A - 230V AC

5736 10	20A - Switch - SP - 1 Way - 1 Module	590	1/20/200
5736 52	20A - Switch - SP - 1 Way - 2 Module	694	1/10/100
5725 63	20A - Switch - SP - 1 Way - with Indicator - 1 Module	620	1/20/200
5736 11	20A - Switch - SP - 2 Way - with Indicator - 1 Module	850	1/20/200
5725 42	20A - Switch - SP - 2 Way - with Indicator - 2 Module	910	1/5/50
5725 43	20A - Switch - 3 Gang - 1 Way - 2 Module	1682	1/10/100
5725 44	20A - Switch - 3 Gang - 2*2 Way + 1*1 Way - 2 Module	1756	1/10/100
5736 54	20A - Switch - DP - 1 Way - with Indicator - 2 Module	1360	1/10/100
5725 49	20A - Switch - DP - 1 Way - with Indicator & Water Heater Marking - 2 Module	1452	1/10/100

Switches - 25A - 230V AC

5736 17	25A - Switch - 1 Way - with Indicator - 1 Module	782	1/20/200
---------	--	-----	----------

Switches - 32A - 230V AC

5736 12	32A - Switch - DP - 1 Way - with Indicator - 2 Module	1896	1/10/100
---------	---	------	----------

Push Button - 6A - 230V AC

5736 13	6A - Bell Push - SP - 1 Way - 1 Module	472	1/20/200
5736 59	6A - Bell Push - SP - 1 Way - 2 Module	674	1/10/100
5736 04	6A - Push Button - SP - 1 Way - 1 Module	490	1/20/200
5736 05	6A - Push Button - SP - 1 Way - with Indicator - 1 Module	654	1/20/200

* MRP - Maximum Retail Price Inclusive of all taxes including GST.

Bold Cat.Nos are products normally available with Legrand (India) Stockists. **Cat.Nos** that are not bold - delivery within 4 - 8 weeks from the date of order. **Bold packing quantity** is our mandatory packing. Orders to be placed by Legrand (India) Stockist in multiples of the same.

Arteor™

Square Magnesium Mechanism

Cat.Nos	Description	MRP* ₹ / Unit	Pack
---------	-------------	------------------	------

Push Button – 6A - 230V AC

5736 14	6A - Bell Push - SP - 1 Way - with Indicator - 1 Module	650	1/20/200
5736 60	6A - Bell Push - SP - 1 Way - with Indicator - 2 Module	908	1/10/100

Electric Roller Blinds Control

5727 20	Double Switch for Electric Shutter - 2 Module	1190	1/10/100
---------	---	------	----------

Dimmers & Fan Regulators

5736 62	Light Dimmer - 60 to 400 Watts - 2 Module	1986	1/10/100
5736 16	Fan Step Regulator - 100 Watts - ISI - 1 Module	1632	1/5/50
5736 63	Fan Step Regulator - 100 Watts - ISI - 2 Module	2012	1/10/100
5736 69	Fan Step Regulator - 120 Watts - ISI - 2 Module (for 48 & 56" Fans)	2154	1/10/100
5736 68	Fan Step Regulator - for Energy Saving Fans - 2 Module	2136	1/10/100
5736 56	Fan Regulator - 8 Steps - 100 Watts - ISI - 2 Module	1910	1/10/100

Indian Standard Sockets

5736 24	6A - Socket - with Shutter - 3 Pin - ISI - 2 Module	420	1/20/200
5736 71	6/16A - Socket - with Shutter - 3 Pin - Indian - ISI - 2 Module	824	1/10/100
5736 67	6/16A - Socket - with Shutter - 3 Pin - Indian - ISI - 3 Module	1004	1/5/50
5737 10	16A - Socket Shutter with Switch - 3 Pin - 2P+E - Indian - 3 Module	2320	5/50

USB Chargers (IS13252 (Part 1) / IEC 60950-1)

5734 44	USB Charger - 1500mA - Type A - 1 Module	3140	1/5/50
5716 81	USB Charger - 3000mA/15 Watts - Type A - 1 Module	3532	1/10/150

Arteor™

Square Magnesium Mechanism

Cat.Nos	Description	MRP* ₹ / Unit	Pack
---------	-------------	------------------	------

USB Chargers (IS13252 (Part 1) / IEC 60950-1)

5716 85	USB Charger - 3000mA/15 Watts - Type A + A - 1 Module	4028	1/10/150
5716 89	USB Charger - 3000mA/15 Watts - Type A + C - 1 Module	4620	1/10/150
5716 93	USB Charger - 3000mA/15 Watts - Type C + C - 1 Module	5048	1/10/150
5716 97	USB Charger - Power Delivery - 20 Watts - Type C - 1 Module	6638	1/10/150
5734 82	USB Charger - Power Delivery - 30 Watts - Type C + C - 2 Module	9698	1/20
5754 82	USB Charger - Power Delivery - 45 Watts - Type C - 2 Module	12514	1/20
NEW! 5754 95	USB Charger - Power Delivery - 65 Watts - Type C + C - 3 Module	15328	1/20

Data & Voice

5736 27	Telephone Socket - Double RJ11 - 1 Module	742	1/20/200
5736 26	Telephone Socket - RJ11 - with Shutter - 1 Module	448	1/20/200
5736 29	Information Socket - RJ45 - Cat 5E - UTP - 1 Module	846	1/20/200
5736 28	Information Socket - RJ45 - Cat 6 - UTP - 1 Module	1290	1/20/200
5736 74	Information Socket - RJ45 - Cat 6 - UTP - 2 Module	1360	1/10/100

TV Sockets

5736 25	TV Co - axial Socket - 1 Module	460	1/20/200
---------	---------------------------------	-----	----------

Electronic Chime

5736 43	Bell Ding Dong - 230V - 2 Module	736	1/10/100
---------	----------------------------------	-----	----------

Buzzer

5736 42	Buzzer - 230V - 1 Module	1994	1/20/200
---------	--------------------------	------	----------

Bell Call Indicator & Register - 6A - 230V AC

5736 15	6A - Bell Call Indicator - SP - with Register - 1 Way - 1 Module	3042	1/20/200
---------	--	------	----------

* MRP - Maximum Retail Price Inclusive of all taxes including GST.
Red Cat. Nos - New Products

Bold Cat.Nos are products normally available with Legrand (India) Stockists. Cat.Nos that are not bold - delivery within 4 - 8 weeks from the date of order. Bold packing quantity is our mandatory packing. Orders to be placed by Legrand (India) Stockist in multiples of the same.

Arteor™

Square Magnesium Mechanism

Cat.Nos	Description	MRP* ₹ / Unit	Pack
---------	-------------	------------------	------

Lighting

5735 64	Skirting Light - with LED - 230V - 3 Module	1638	1/10/100
5727 26	Skirting Light - with Detector (LED) - 230V - 2 Module	21352	1/20

Hospitality Function

Hotel "DND and MMR " functions

5736 61	External DND & MMR Control Unit - with Bell Push - 2 Module	3250	1/5/50
5736 58	Internal DND & MMR Control Unit - 2 Module	2352	1/10/100

Hotel Keycard Switch

5727 44	16A - Key Card Switch - 230V - with Time Delay - 2 Module	8532	1/10
5727 59	Key Fob for Key Card Switch	2934	10/50

Shaver Socket

5726 53	Shaver Socket - 230V/120 - 230V - with Earth Connector	8870	1
---------	--	------	---

Time Switch

5740 84	Time Delay Switch - 2 Module	10574	1/20
---------	------------------------------	-------	------

Audio - Video Connector

5727 72	Double RCA Socket (Audio) - 1 Module	7564	1/20
5727 73	Triple RCA Socket (Audio & Video) - 1 Module	5901	1/20
5727 74	Female 3.5mm Jack - 1 Module	6712	1/20
5727 76	Female BNC 75 Jack - 1 Module	6528	1/20
5727 83	Female XLR Jack - 2 Module	11737	1/20
5725 97	Preterminated Sockets Female Hd15 - 1 Module	9255	1
5725 96	Preterminated HDMI Socket - 1.4 - 1 Module	10494	1
5727 84	Line Dying Down - 100V (25 - 30W) - 2 Module	18788	1

* MRP - Maximum Retail Price Inclusive of all taxes including GST.

Arteor™

Square Magnesium Mechanism

Cat.Nos	Description	MRP* ₹ / Unit	Pack
---------	-------------	------------------	------

Audio - Video Connector

5727 75	USB Socket - 1 Module	5245	1/20
5727 88	Female HD15 + Jack 3.5mm - 2 Module	7365	1/20

Blanking Plate

5736 49	Blanking Plate - 1 Module	70	1/40/400
5728 44	Blanking Plate - 2 Module	122	1/10/100

Dedicated Switches

5738 02	20A - Dedicated Switch - DP - 1 Way - 1 Module - Red	1366	1/10/100
---------	--	------	----------

Tamper Proof & Dedicated Sockets

5738 10	16A - Dedicated Socket with Switch - 3 Pin - 2P+E - Indian - 3 Module	2842	1/10/100
---------	---	------	----------

Square - Champagne Mechanism

Switches - 6A - 230V AC

5748 00	6A - Switch - SP - 1 Way - 1 Module	272	1/20/200
5748 01	6A - Switch - SP - 1 Way - with Indicator - 1 Module	492	1/20/200
5748 02	6A - Switch - SP - 2 Way - 1 Module	444	1/20/200
5748 03	6A - Switch - SP - 2 Way - with Indicator - 1 Module	630	1/20/200

Switches - 10A - 230V AC

5748 04	10A - Switch - SP - 1 Way - 2 Module	488	1/10/100
5748 05	10A - Switch - SP - 2 Way - 2 Module	574	1/10/100
5748 06	10A - Switch - SP - 2 Way - with Indicator & Label Holder - 2 Module	2876	1/10/100
5748 07	10A - Intermediate Switch - 230V AC - 2 Module	3516	1/10/100

Switches - 20A - 230V AC

5748 08	20A - Switch - SP - 1 Way - 1 Module	590	1/20/200
5748 09	20A - Switch - SP - 1 Way - 2 Module	694	1/10/100
5748 10	20A - Switch - SP - 1 Way - with Indicator - 1 Module	620	1/20/200
5748 11	20A - Switch - SP - 2 Way - with Indicator - 1 Module	850	1/20/200

Bold Cat.Nos are products normally available with Legrand (India) Stockists. Cat.Nos that are not bold - delivery within 4 - 8 weeks from the date of order. Bold packing quantity is our mandatory packing. Orders to be placed by Legrand (India) Stockist in multiples of the same.

Arteor™

Square Champagne Mechanism

Cat.Nos	Description	MRP* ₹ / Unit	Pack
---------	-------------	------------------	------

Switches – 20A - 230V AC

5748 12	20A - Switch - SP - 2 Way - with Indicator - 2 Module	910	1/10/100
5748 13	20A - Switch - 3 Gang - 1 Way - 2 Module	1680	1/10/100
5748 14	20A - Switch - 3 Gang - 2*2 Way + 1*1 Way - 2 Module	1756	1/10/100
5748 15	20A - Switch - DP - 1 Way - with Indicator - 2 Module	1360	1/10/100
5748 16	20A - Switch - DP - 1 Way - with Indicator & Water Heater Marking - 2 Module	1452	1/10/100

Switches – 25A - 230V AC

5748 17	25A - Switch - 1 Way - with Indicator - 1 Module	782	1/20/200
---------	--	-----	----------

Switches – 32A / 40A - 230V AC

5748 18	32A - Switch - DP - 1 Way - with Indicator - 2 Module	1896	1/10/100
5748 19	40A - Switch - DP - 1 Way - with Indicator - fits on 1/2 Module Box	2180	1/5/20

Push Button – 6A - 230V AC

5748 23	6A - Bell Push - SP - 1 Way - 1 Module	472	1/20/200
5748 24	6A - Bell Push - SP - 1 Way - 2 Module	674	1/10/100
5748 21	6A - Push Button - SP - 1 Way - 1 Module	490	1/20/200
5748 22	6A - Push Button - SP - 1 Way - with Indicator - 1 Module	654	1/20/200
5748 25	6A - Bell Push - SP - 1 Way - with Indicator - 1 Module	650	1/20/200
5748 26	6A - Bell Push - SP - 1 Way - with Indicator - 2 Module	908	1/10/100

Electric Roller Blinds Control

5748 20	Double Switch for Electric Shutter - 2 Module	1190	1/10/100
---------	---	------	----------

Dimmers & Fan Regulators

5748 27	Light Dimmer - 60 to 400 Watts - 2 Module	2042	10/100
5748 29	Fan Step Regulator - 100 Watts - ISI - 1 Module	1632	1/5/50
5748 30	Fan Step Regulator - 100 Watts - ISI - 2 Module	2012	1/10/100
5748 31	Fan Step Regulator - 120 Watts - ISI - 2 Module (for 48 & 56" Fans)	2154	1/10/100
5748 32	Fan Step Regulator - for Energy Saving Fans - 2 Module	2136	1/10/100

Arteor™

Square Champagne Mechanism

Cat.Nos	Description	MRP* ₹ / Unit	Pack
---------	-------------	------------------	------

5736 57	Fan Regulator - 8 Steps - 100 Watts - ISI - 2 Module	1910	1/10/100
---------	--	------	----------

Indian Standard Sockets

5748 84	6A - Socket - with Shutter - 3 Pin - ISI - 2 Module	420	1/20/200
5748 34	6/16A - Socket - with Shutter - 3 Pin - Indian - ISI - 2 Module	824	1/10/100
5748 35	6/16A - Socket - with Shutter - 3 Pin - Indian - ISI - 3 Module	1004	1/5/50

USB Chargers (IS13252 (part 1) / IEC 60950-1)

5734 47	USB Charger - 1500mA - Type A - 1 Module	3140	1/5/50
5716 82	USB Charger - 3000mA/15 Watts - Type A - 1 Module	3532	1/10/150
5716 86	USB Charger - 3000mA/15 Watts - Type A + A - 1 Module	4028	1/10/150
5716 90	USB Charger - 3000mA/15 Watts - Type A + C - 1 Module	4620	1/10/150
5716 94	USB Charger - 3000mA/15 Watts - Type C + C - 1 Module	5048	1/10/150
5716 98	USB Charger - Power Delivery - 20 Watts - Type C - 1 Module	6638	1/10/150
5734 83	USB Charger - Power Delivery - 30 Watts - Type C + C - 2 Module	9698	1/20
5754 83	USB Charger - Power Delivery - 45 Watts - Type C - 2 Module	12514	1/20
5754 96	USB Charger - Power Delivery - 65 Watts - Type C + C - 3 Module	15328	1/20

Data & Voice

5748 45	Telephone Socket - Double RJ11 - 1 Module	742	1/20/200
5748 46	Telephone Socket - RJ11 - with Shutter - 1 Module	448	1/20/200
5748 47	Information Socket - RJ45 - Cat 5E - UTP - 1 Module	846	1/20/200
5748 48	Information Socket - RJ45 - Cat 5E - UTP - 2 Module	909	1/10/100
5748 49	Information Socket - RJ45 - Cat 6 - UTP - 1 Module	1290	1/20/200
5748 50	Information Socket - RJ45 - Cat 6 - UTP - 2 Module	1360	1/10/100

TV Sockets

5748 51	TV Co - axial Socket - 1 Module	460	1/20/200
---------	---------------------------------	-----	----------

Electronic Chime

5748 52	Bell Ding Dong - 230V - 2 Module	736	1/10/100
---------	----------------------------------	-----	----------

* MRP - Maximum Retail Price Inclusive of all taxes including GST.
Red Cat. Nos - New Products

Bold Cat.Nos are products normally available with Legrand (India) Stockists. Cat.Nos that are not bold - delivery within 4 - 8 weeks from the date of order. Bold packing quantity is our mandatory packing. Orders to be placed by Legrand (India) Stockist in multiples of the same.

Arteor™

Square Champagne Mechanism

Cat.Nos	Description	MRP* ₹ / Unit	Pack
---------	-------------	------------------	------

Buzzer

5748 53	Buzzer - 230V - 1 Module	1994	1/20/200
---------	--------------------------	------	----------

Bell Call Indicator & Register - 6A - 230V AC

5748 54	6A - Bell Call Indicator - SP - with Register - 1 Way - 1 Module	3042	1/20/200
---------	--	------	----------

Lighting

5748 55	Skirting Light - with LED - 230V - 3 Module	1638	1/10/100
---------	---	------	----------

Hospitality Function

Hotel "DND and MMR" Functions

5748 56	External DND & MMR Control Unit - with Bell Push - 2 Module	3250	1/5/50
5748 57	Internal DND & MMR Control Unit - 2 Module	2352	1/10/100

Hotel Keycard Switch

5748 58	16A - Key Card Switch - 230V - with Time Delay - 2 Module	8410	1/0/10
5727 59	Key Fob for Key Card Switch	2934	10/50

Blanking Plate

5748 63	Blanking Plate - 1 Module	70	1/40/400
5748 64	Blanking Plate - 2 Module	122	1/10/100

Round - White Mechanism

Switches - 6A - 230V AC

5733 00	6A - Switch - SP - 1 Way - Left - 1 Module	346	1/20/200
5733 01	6A - Switch - SP - 1 Way - Right - 1 Module	346	1/20/200
5733 12	6A - Switch - SP - 1 Way - Middle - 1 Module	346	1/20/200
5733 05	6A - Switch - SP - 2 Way - Left - 1 Module	458	1/20/200
5733 06	6A - Switch - SP - 2 Way - Right - 1 Module	458	1/20/200
5733 02	6A - Switch - SP - 1 Way - with Indicator - Left - 1 Module	522	1/20/200
5733 04	6A - Switch - SP - 1 Way - with Indicator - Right - 1 Module	522	1/20/200

Arteor™

Round White Mechanism

Cat.Nos	Description	MRP* ₹ / Unit	Pack
---------	-------------	------------------	------

Switches - 6A - 230V AC

5733 03	6A - Switch - SP - 1 Way - with Indicator - Middle - 1 Module	522	1/20/200
5733 07	6A - Switch - SP - 2 Way - with Indicator - Left - 1 Module	652	1/20/200
5733 08	6A - Switch - SP - 2 Way - with Indicator - Right - 1 Module	652	1/20/200

Switches - 20A - 230V AC

5733 20	20A - Switch - SP - 1 Way - Left - 1 Module	626	1/20/200
5733 21	20A - Switch - SP - 1 Way - Right - 1 Module	626	1/20/200
5730 21	20A - Switch - SP - 1 Way - Middle - 1 Module	642	1/10/100
5733 40	20A - Switch - SP - 1 Way - 2 Module	732	1/10/100
5720 64	20A - Switch - SP - 1 Way - with Indicator - Left - 1 Module	648	1/20/200
5720 65	20A - Switch - SP - 1 Way - with Indicator - Right - 1 Module	648	1/20/200
5730 24	20A - Switch - SP - 2 Way - Middle - 1 Module	650	1/10/100
5733 22	20A - Switch - SP - 2 Way - with Indicator - Left - 1 Module	896	1/20/200
5733 23	20A - Switch - SP - 2 Way - with Indicator - Right - 1 Module	896	1/20/200
5730 71	20A - Switch - SP - 2 Way - with Indicator - 2 Module	798	1/5/50
5730 72	20A - Switch - 3 Gang - 1 Way - 2 Module	1754	1/10/100
5730 73	20A - Switch - 3 Gang - 2*2 Way + 1*1 Way - 2 Module	1932	1/10/100
5733 42	20A - Switch - DP - 1 Way - with Indicator - 2 Module	1360	1/10/100

Switches - 32A - 230V AC

5733 26	32A - Switch - DP - 1 Way - with Indicator - 2 Module	1982	1/10/100
---------	---	------	----------

Push Button - 6A - 230V AC

5733 31	6A - Bell Push - SP - 1 Way - Right - 1 Module	490	1/20/200
5733 30	6A - Bell Push - SP - 1 Way - Left - 1 Module	490	1/20/200
5733 46	6A - Bell Push - SP - 1 Way - 2 Module	696	1/10/100
5733 47	6A - Bell Push - SP - 1 Way - with Indicator - 2 Module	946	1/10/100

Electronic Roller Blinds Control

5732 20	Double Switch For Electric Shutter - 2 Module	1240	1/10/100
---------	---	------	----------

* MRP - Maximum Retail Price Inclusive of all taxes including GST.

Bold Cat.Nos are products normally available with Legrand (India) Stockists. Cat.Nos that are not bold - delivery within 4 - 8 weeks from the date of order. Bold packing quantity is our mandatory packing. Orders to be placed by Legrand (India) Stockist in multiples of the same.

Arteor™

Round White Mechanism



5730 66

Cat.Nos	Description	MRP* ₹ / Unit	Pack
Dimmers & Fan Regulators			
5730 66	Light Dimmer - 60 to 400 Watts - 2 Module	2068	1/10/100
5730 03	Fan Step Regulator - 100 Watts - ISI - 2 Module	2096	1/10/100
5730 69	Fan Step Regulator - 120 Watts - ISI - 2 Module	2272	1/10/100
5730 04	Fan Step Regulator - for Energy Saving Fans - 2 Module	2224	1/10/100

Indian Standard Sockets

5734 94	6A - Socket - with Shutter - 3 Pin - ISI - 2 Module	748	1/20/200
---------	---	-----	----------

Data & Voice



5723 24

5723 24	Information Socket - RJ45 - Cat 6 - UTP - 2 Module	1513	10/100
---------	--	------	--------

Hotel "DND & MMR" Functions



5720 74

5720 74	Internal DND & MMR Control Unit - 2 Module	2848	1/5/50
5720 67	External DND & MMR Control Unit - with Bell Push - 2 Module	3578	5/40

Blanking Plate



5730 87

5730 87	Blanking Plate - 2 Module	124	1/10/100
---------	---------------------------	-----	----------

Round - Magnesium Mechanism

Switches - 6A - 230V AC



5733 50



5733 51



5733 62

5733 50	6A - Switch - SP - 1 Way - Left - 1 Module	400	1/20/200
5733 51	6A - Switch - SP - 1 Way - Right - 1 Module	400	1/20/200
5733 62	6A - Switch - SP - 1 Way - Middle - 1 Module	402	1/20/200
5733 55	6A - Switch - SP - 2 Way - Left - 1 Module	528	1/20/200
5733 56	6A - Switch - SP - 2 Way - Right - 1 Module	528	1/20/200
5733 52	6A - Switch - SP - 1 Way - with Indicator - Left - 1 Module	586	1/20/200

* MRP - Maximum Retail Price Inclusive of all taxes including GST.

Arteor™

Round Magnesium Mechanism



5733 70



5733 71



5733 72



5733 92



5733 76



5733 81

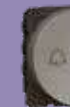

5733 80

Cat.Nos	Description	MRP* ₹ / Unit	Pack
Switches - 6A - 230V AC			
5733 54	6A - Switch - SP - 1 Way - with Indicator - Right - 1 Module	586	1/20/200
5733 57	6A - Switch - SP - 2 Way - with Indicator - Left - 1 Module	756	1/20/200
5733 58	6A - Switch - SP - 2 Way - with Indicator - Right - 1 Module	756	1/20/200

Switches - 20A - 230V AC

5733 70	20A - Switch - SP - 1 Way - Left - 1 Module	698	1/20/200
5733 71	20A - Switch - SP - 1 Way - Right - 1 Module	698	1/20/200
5731 21	20A - Switch - SP - 1 Way - Middle - 1 Module	698	1/10/100
5733 90	20A - Switch - SP - 1 Way - 2 Module	830	1/10/100
5725 64	20A - Switch - SP - 1 Way - with Indicator - Left - 1 Module	732	1/20/200
5725 65	20A - Switch - SP - 1 Way - with Indicator - Right - 1 Module	732	1/20/200
5731 24	20A - Switch - SP - 2 Way - Middle - 1 Module	744	1/10/100
5733 72	20A - Switch - SP - 2 Way - with Indicator - Left - 1 Module	1014	1/20/200
5733 73	20A - Switch - SP - 2 Way - with Indicator - Right - 1 Module	1014	1/20/200
5731 71	20A - Switch - SP - 2 Way - with Indicator - 2 Module	962	1/5/50
5731 72	20A - Switch - 3 Gang - 1 Way - 2 Module	2014	1/5/50
5731 73	20A - Switch - 3 Gang - 2*2 Way + 1*1 Way - 2 Module	2124	1/5/50
5733 92	20A - Switch - DP - 1 Way - with Indicator - 2 Module	1572	1/10/100
5731 27	20A - Switch - SP - 2 Way - with Indicator - Middle - 1 Module	1016	1/5/50

Switches - 32A - 230V AC

5733 76	32A - Switch - DP - 1 Way - with Indicator - 2 Module	2270	1/10/100
---------	---	------	----------

Push Button - 6A - 230V AC

5733 81	6A - Bell Push - SP - 1 Way - Right - 1 Module	574	1/20/200
5733 80	6A - Bell Push - SP - 1 Way - Left - 1 Module	574	1/20/200
5733 96	6A - Bell Push - SP - 1 Way - 2 Module	816	1/10/100
5733 97	6A - Bell Push - SP - 1 Way - with Indicator - 2 Module	1072	1/10/100

Bold Cat.Nos are products normally available with Legrand (India) Stockists. **Cat.Nos** that are not bold - delivery within 4 - 8 weeks from the date of order. **Bold packing quantity** is our mandatory packing. Orders to be placed by Legrand (India) Stockist in multiples of the same.

Arteor™

Round Magnesium Mechanism

Cat.Nos	Description	MRP* ₹ / Unit	Pack
---------	-------------	------------------	------

Electronic Roller Blinds Control

5737 20	Double Switch for Electric Shutter - 2 Module	1434	1/10/100
---------	---	------	----------

Dimmers & Fan Regulators

5733 66	Light Dimmer - 60 to 400 Watts - 2 Module	2396	1/10/100
5731 03	Fan Step Regulator - 100 Watts - ISI - 2 Module	2410	1/10/100
5731 69	Fan Step Regulator - 120 Watts - ISI - 2 Module	2598	1/10/100
5731 04	Fan Step Regulator - for Energy Saving Fans - 2 Module	2570	1/10/100



5731 03

Indian Standard Sockets

5736 94	6A - Socket - with Shutter - 3 Pin - ISI - 2 Module	864	1/20/200
---------	---	-----	----------



5728 24

Data & Voice

5728 24	Information Socket - RJ45 - Cat 6 - UTP - 2 Module	1727	10/100
---------	--	------	--------



5725 74

Hotel "DND and MMR" Functions

5725 74	Internal DND & MMR Control Unit - 2 Module	3264	1/5/50
5725 67	External DND & MMR Control Unit - with Bell Push - 2 Module	3906	5/40



5725 67

Blanking Plate

5731 87	Blanking Plate - 2 Module	146	1/10/100
---------	---------------------------	-----	----------

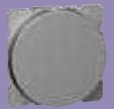

5731 87

Round - Champagne Mechanism

Switches - 6A - 230V AC

5749 00	6A - Switch - SP - 1 Way - Left - 1 Module	400	1/20/200
5749 01	6A - Switch - SP - 1 Way - Right - 1 Module	400	1/20/200
5749 02	6A - Switch - SP - 1 Way - Middle - 1 Module	400	1/20/200
5749 03	6A - Switch - SP - 2 Way - Left - 1 Module	528	1/20/200
5749 04	6A - Switch - SP - 2 Way - Right - 1 Module	528	1/20/200
5749 05	6A - Switch - SP - 1 Way - with Indicator - Left - 1 Module	586	1/20/200
5749 06	6A - Switch - SP - 1 Way - with Indicator - Right - 1 Module	586	1/20/200
5749 07	6A - Switch - SP - 1 Way - with Indicator - Middle - 1 Module	586	1/20/200



5749 00



5749 01



5749 02



5749 03

Arteor™

Round Champagne Mechanism

Cat.Nos	Description	MRP* ₹ / Unit	Pack
---------	-------------	------------------	------

5749 08	6A - Switch - SP - 2 Way - with Indicator - Left - 1 Module	756	1/20/200
5749 09	6A - Switch - SP - 2 Way - with Indicator - Right - 1 Module	756	1/20/200

Switches - 20A - 230V AC

5749 10	20A - Switch - SP - 1 Way - Left - 1 Module	698	1/20/200
5749 11	20A - Switch - SP - 1 Way - Right - 1 Module	698	1/20/200
5749 12	20A - Switch - SP - 1 Way - Middle - 1 Module	698	1/20/200
5749 13	20A - Switch - SP - 1 Way - 2 Module	830	1/10/200
5749 14	20A - Switch - SP - 1 Way - with Indicator - Left - 1 Module	732	1/20/200
5749 15	20A - Switch - SP - 1 Way - with Indicator - Right - 1 Module	732	1/20/200
5749 16	20A - Switch - SP - 2 Way - Middle - 1 Module	742	1/20/200
5749 17	20A - Switch - SP - 2 Way - with Indicator - Left - 1 Module	1016	1/20/200
5749 18	20A - Switch - SP - 2 Way - with Indicator - Right - 1 Module	1016	1/20/200
5749 19	20A - Switch - SP - 2 Way - with Indicator - 2 Module	962	1/10/100
5749 20	20A - Switch - 3 Gang - 1 Way - 2 Module	2014	1/10/100
5749 21	20A - Switch - 3 Gang - 2*2 Way + 1*1 Way - 2 Module	2124	1/10/100
5749 22	20A - Switch - DP - 1 Way - with Indicator - 2 Module	1572	1/10/100



5749 16



5749 17



5749 18



5749 22

Push Button - 6A - 230V AC

5749 23	6A - Bell Push - SP - 1 Way - Right - 1 Module	574	1/20/200
5749 24	6A - Bell Push - SP - 1 Way - Left - 1 Module	574	1/20/200
5749 25	6A - Bell Push - SP - 1 Way - 2 Module	816	1/10/100
5749 26	6A - Bell Push - SP - 1 Way - with Indicator - 2 Module	1072	1/10/100



5749 26

Dimmers & Fan Regulators

5749 27	Light Dimmer - 60 to 400 Watts - 2 Module	2476	10/100
5749 29	Fan Step Regulator - 100 Watts - ISI - 2 Module	2410	1/10/100
5749 30	Fan Step Regulator - 120 Watts - ISI - 2 Module	2598	1/10/100
5749 31	Fan Step Regulator - for Energy Saving Fans - 2 Module	2570	1/10/100



5749 27

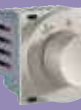

5749 29

* MRP - Maximum Retail Price Inclusive of all taxes including GST.

Bold Cat.Nos are products normally available with Legrand (India) Stockists. Cat.Nos that are not bold - delivery within 4 - 8 weeks from the date of order. Bold packing quantity is our mandatory packing. Orders to be placed by Legrand (India) Stockist in multiples of the same.

Arteor™

Square Cover Plates with Metal Frame

Cat.Nos	Description	MRP* ₹ / Unit	Pack
Indian Standard Sockets			
5749 94	6A - Socket - with Shutter - 3 Pin - ISI - 2 Module	864	1/20/200

Blanking Plate

5749 64	Blanking Plate - 2 Module	146	10/100
---------	---------------------------	-----	--------

Square Cover Plates with Metal Frame White Cover Plates with Metal Frame

5757 00	Cover Plate - 1 Module - White	326	10/100
5757 10	Cover Plate - 2 Module - White	344	10/100
5757 20	Cover Plate - 3 Module - White	386	10/100
5757 30	Cover Plate - 4 Module - White	404	5/50
5757 40	Cover Plate - 6 Module - White	738	5/30
5757 50	Cover Plate - 8 Module - White	820	5/30
5757 60	Cover Plate - 2*4 Module - White	1034	2/20
5757 70	Cover Plate - 2*6 Module - White	1264	2/16
5757 80	Cover Plate - 2*8 Module - White	1514	2/16
5757 90	Cover Plate - 3*6 Module - White	1676	2/12
5758 00	Cover Plate - 3*8 Module - White	2002	2/12
5750 70	Cover Plate - for Shaver Socket-3 Module - White	574	5/50

Pearl Aluminium Cover Plates with Metal Frame

5759 73	Cover Plate - 1 Module - Pearl Aluminium	488	10/100
5759 74	Cover Plate - 2 Module - Pearl Aluminium	506	1/10/100
5759 75	Cover Plate - 3 Module - Pearl Aluminium	548	10/100
5759 76	Cover Plate - 4 Module - Pearl Aluminium	620	5/50
5759 77	Cover Plate - 6 Module - Pearl Aluminium	1068	5/30
5759 78	Cover Plate - 8 Module - Pearl Aluminium	1170	1/5/30
5759 79	Cover Plate - 2*4 Module - Pearl Aluminium	1492	2/20
5759 80	Cover Plate - 2*6 Module - Pearl Aluminium	1934	1/2/16
5759 81	Cover Plate - 2*8 Module - Pearl Aluminium	2188	2/16
5759 82	Cover Plate - 3*6 Module - Pearl Aluminium	2560	2/12
5759 83	Cover Plate - 3*8 Module - Pearl Aluminium	2914	2/12

Graphite Cover Plates with Metal Frame

5759 61	Cover Plate - 1 Module - Graphite	488	10/100
5759 62	Cover Plate - 2 Module - Graphite	506	1/10/100
5759 63	Cover Plate - 3 Module - Graphite	548	10/100
5759 64	Cover Plate - 4 Module - Graphite	620	5/50
5759 66	Cover Plate - 6 Module - Graphite	1068	5/30

Arteor™

Square Cover Plates with Metal Frame

Cat.Nos	Description	MRP* ₹ / Unit	Pack
---------	-------------	------------------	------

Graphite Cover Plates with Metal Frame

5759 67	Cover Plate - 8 Module - Graphite	1170	1/5/30
5759 68	Cover Plate - 2*4 Module - Graphite	1492	2/20
5759 69	Cover Plate - 2*6 Module - Graphite	1934	1/2/16
5759 70	Cover Plate - 2*8 Module - Graphite	2188	2/16
5759 71	Cover Plate - 3*6 Module - Graphite	2560	2/12
5759 72	Cover Plate - 3*8 Module - Graphite	2914	2/12

Magnesium Cover Plates with Metal Frame

5755 89	Cover Plate - 1 Module - Magnesium	488	10/100
5755 90	Cover Plate - 2 Module - Magnesium	506	1/10/100
5755 91	Cover Plate - 3 Module - Magnesium	548	10/100
5755 93	Cover Plate - 4 Module - Magnesium	620	5/50
5755 94	Cover Plate - 6 Module - Magnesium	1068	1/5/30
5755 95	Cover Plate - 8 Module - Magnesium	1170	1/5/30
5755 96	Cover Plate - 2*4 Module - Magnesium	1492	1/2/20
5755 97	Cover Plate - 2*6 Module - Magnesium	1934	1/2/16
5755 98	Cover Plate - 2*8 Module - Magnesium	2188	2/16
5755 99	Cover Plate - 3*6 Module - Magnesium	2560	2/12

Champagne Cover Plates with Metal Frame

5759 84	Cover Plate - 1 Module - Champagne	488	10/100
5759 85	Cover Plate - 2 Module - Champagne	506	1/10/100
5759 86	Cover Plate - 3 Module - Champagne	548	10/100
5759 87	Cover Plate - 4 Module - Champagne	620	5/50
5759 88	Cover Plate - 6 Module - Champagne	1068	5/30
5759 89	Cover Plate - 8 Module - Champagne	1170	1/5/30
5759 90	Cover Plate - 2*4 Module - Champagne	1492	2/20
5759 91	Cover Plate - 2*6 Module - Champagne	1934	1/2/16
5759 92	Cover Plate - 2*8 Module - Champagne	2188	2/16
5759 93	Cover Plate - 3*6 Module - Champagne	2560	2/12

Dark Bronze Cover Plates with Metal Frame

5756 79	Cover Plate - 1 Module - Dark Bronze	488	10/100
5756 80	Cover Plate - 2 Module - Dark Bronze	506	1/10/100
5756 81	Cover Plate - 3 Module - Dark Bronze	548	10/100

* MRP - Maximum Retail Price Inclusive of all taxes including GST.

Bold Cat.Nos are products normally available with Legrand (India) Stockists. **Cat.Nos that are not bold** - delivery within 4 - 8 weeks from the date of order. **Bold packing quantity** is our mandatory packing. Orders to be placed by Legrand (India) Stockist in multiples of the same.

Square Cover Plates with Metal Frame

Cat.Nos	Description	MRP* ₹ / Unit	Pack
---------	-------------	------------------	------

Dark Bronze Cover Plates with Metal Frame

5756 83	Cover Plate - 4 Module - Dark Bronze	620	5/50
5756 84	Cover Plate - 6 Module - Dark Bronze	1068	5/30
5756 85	Cover Plate - 8 Module - Dark Bronze	1170	1/5/30
5756 86	Cover Plate - 2*4 Module - Dark Bronze	1492	2/20
5756 87	Cover Plate - 2*6 Module - Dark Bronze	1934	1/2/16
5756 88	Cover Plate - 2*8 Module - Dark Bronze	2188	2/16
5756 89	Cover Plate - 3*6 Module - Dark Bronze	2560	2/12

Pearl Aluminium Cover Plates with Overmoulded Frame

5757 01	Cover Plate - 1 Module - Pearl Aluminium	540	10/100
5757 11	Cover Plate - 2 Module - Pearl Aluminium	572	10/100
5757 21	Cover Plate - 3 Module - Pearl Aluminium	608	10/100
5757 31	Cover Plate - 4 Module - Pearl Aluminium	690	5/50
5757 41	Cover Plate - 6 Module - Pearl Aluminium	1172	5/30
5757 51	Cover Plate - 8 Module - Pearl Aluminium	1302	5/30
5757 61	Cover Plate - 2*4 Module - Pearl Aluminium	1652	2/20
5757 71	Cover Plate - 2*6 Module - Pearl Aluminium	2146	2/16
5757 81	Cover Plate - 2*8 Module - Pearl Aluminium	2438	2/16
5757 91	Cover Plate - 3*6 Module - Pearl Aluminium	2852	2/12
5758 01	Cover Plate - 3*8 Module - Pearl Aluminium	3236	2/12
5750 71	Cover Plate - for Shaver Socket-3 Module - Pearl Aluminium	920	5/50

Graphite Cover Plates with Overmoulded Frame

5757 02	Cover Plate - 1 Module - Graphite	540	10/100
5757 12	Cover Plate - 2 Module - Graphite	572	10/100
5757 22	Cover Plate - 3 Module - Graphite	608	10/100
5757 32	Cover Plate - 4 Module - Graphite	690	5/50
5757 42	Cover Plate - 6 Module - Graphite	1172	5/30
5757 52	Cover Plate - 8 Module - Graphite	1302	5/30
5757 62	Cover Plate - 2*4 Module - Graphite	1652	2/20
5757 72	Cover Plate - 2*6 Module - Graphite	2146	2/16

Square Cover Plates

Cat.Nos	Description	MRP* ₹ / Unit	Pack
---------	-------------	------------------	------

Graphite Cover Plates with Overmoulded Frame

5757 82	Cover Plate - 2*8 Module - Graphite	2438	2/16
5757 92	Cover Plate - 3*6 Module - Graphite	2852	2/12
5758 02	Cover Plate - 3*8 Module - Graphite	3238	2/12
5750 72	Cover Plate - for Shaver Socket-3 Module - Graphite	920	5/50

Magnesium Cover Plates with Overmoulded Frame

5758 11	Cover Plate - 1 Module - Magnesium	540	10/100
5758 12	Cover Plate - 2 Module - Magnesium	572	10/100
5758 13	Cover Plate - 3 Module - Magnesium	608	10/100
5758 14	Cover Plate - 4 Module - Magnesium	690	1/5/50
5758 15	Cover Plate - 6 Module - Magnesium	1172	5/30
5758 16	Cover Plate - 8 Module - Magnesium	1302	5/30
5758 17	Cover Plate - 2*4 Module - Magnesium	1652	2/20
5758 18	Cover Plate - 2*6 Module - Magnesium	2146	2/16
5758 19	Cover Plate - 2*8 Module - Magnesium	2438	2/16
5758 20	Cover Plate - 3*6 Module - Magnesium	2852	2/12
5758 21	Cover Plate - for Shaver Socket-3 Module - Magnesium	924	5/50

Champagne Cover Plates with Overmoulded Frame

5758 22	Cover Plate - 1 Module - Champagne	540	10/100
5758 23	Cover Plate - 2 Module - Champagne	572	10/100
5758 24	Cover Plate - 3 Module - Champagne	608	10/100
5758 25	Cover Plate - 4 Module - Champagne	690	5/50
5758 26	Cover Plate - 6 Module - Champagne	1172	5/30
5758 27	Cover Plate - 8 Module - Champagne	1302	5/30
5758 28	Cover Plate - 2*4 Module - Champagne	1652	2/20
5758 29	Cover Plate - 2*6 Module - Champagne	2146	2/16
5758 30	Cover Plate - 2*8 Module - Champagne	2438	2/16
5758 31	Cover Plate - 3*6 Module - Champagne	2852	2/12
5758 32	Cover Plate - for Shaver Socket-3 Module - Champagne	924	5/50



5757 21



5757 61



5757 22



5757 42



5758 13



5758 17



5758 24



5758 28

* MRP - Maximum Retail Price Inclusive of all taxes including GST.

Bold Cat.Nos are products normally available with Legrand (India) Stockists. **Cat.Nos that are not bold** - delivery within 4 - 8 weeks from the date of order. **Bold packing quantity** is our mandatory packing. Orders to be placed by Legrand (India) Stockist in multiples of the same.

Arteor™

Square Cover Plates

Cat.Nos	Description	MRP* ₹ / Unit	Pack
Dark Bronze Cover Plates with Overmoulded Frame			
5758 33	Cover Plate - 1 Module - Dark Bronze	540	10/100
5758 34	Cover Plate - 2 Module - Dark Bronze	572	10/100
5758 35	Cover Plate - 3 Module - Dark Bronze	608	10/100
5758 36	Cover Plate - 4 Module - Dark Bronze	690	5/50
5758 37	Cover Plate - 6 Module - Dark Bronze	1172	5/30
5758 38	Cover Plate - 8 Module - Dark Bronze	1302	5/30
5758 39	Cover Plate - 2*4 Module - Dark Bronze	1652	2/20
5758 40	Cover Plate - 2*6 Module - Dark Bronze	2146	2/16
5758 41	Cover Plate - 2*8 Module - Dark Bronze	2438	2/16
5758 42	Cover Plate - 3*6 Module - Dark Bronze	2852	2/12
5758 43	Cover Plate - for Shaver Socket-3 Module - Dark Bronze	924	5/50

Mirror Finish Cover Plates with Overmoulded Frame Mirror Black Cover Plates with Overmoulded Frame

5757 03	Cover Plate - 1 Module - Mirror Black	2756	1/5/30
5757 13	Cover Plate - 2 Module - Mirror Black	2948	1/5/30
5757 23	Cover Plate - 3 Module - Mirror Black	3158	1/20
5757 33	Cover Plate - 4 Module - Mirror Black	3354	1/20
5757 43	Cover Plate - 6 Module - Mirror Black	6106	1/5
5757 53	Cover Plate - 8 Module - Mirror Black	6726	1/5
5757 63	Cover Plate - 2*4 Module - Mirror Black	8524	1/10
5757 73	Cover Plate - 2*6 Module - Mirror Black	10486	1/8

Mirror White Cover Plates with Overmoulded Frame

5757 04	Cover Plate - 1 Module - Mirror White	2756	1/5/30
5757 14	Cover Plate - 2 Module - Mirror White	2948	1/5/30
5757 24	Cover Plate - 3 Module - Mirror White	3158	1/20
5757 34	Cover Plate - 4 Module - Mirror White	3354	1/20
5757 44	Cover Plate - 6 Module - Mirror White	6106	1/5
5757 54	Cover Plate - 8 Module - Mirror White	6726	1/5
5757 64	Cover Plate - 2*4 Module - Mirror White	8680	1/10
5757 74	Cover Plate - 2*6 Module - Mirror White	10486	1/8

Arteor™

Square Cover Plates

Cat.Nos	Description	MRP* ₹ / Unit	Pack
Mirror Green Apple Cover Plates with Overmoulded Frame			
5758 44	Cover Plate - 1 Module - Green Apple	2756	1/5/30
5758 45	Cover Plate - 2 Module - Green Apple	2948	1/5/30
5758 46	Cover Plate - 3 Module - Green Apple	3158	1/20
5758 47	Cover Plate - 4 Module - Green Apple	3354	1/20
5758 48	Cover Plate - 6 Module - Green Apple	6106	1/5
5758 49	Cover Plate - 8 Module - Green Apple	6726	1/5
5758 50	Cover Plate - 2*4 Module - Green Apple	8678	1/10
5758 51	Cover Plate - 2*6 Module - Green Apple	10486	1/8
5758 52	Cover Plate - for Shaver Socket-3 Module - Green Apple	4598	1/5/50

Graphic Casual Cover Plates with Overmoulded Frame

5762 91	Cover Plate - 1 Module - Graphic Casual	3346	1/5/30
5763 11	Cover Plate - 2 Module - Graphic Casual	3600	1/5/30
5763 31	Cover Plate - 3 Module - Graphic Casual	3868	1/20
5763 51	Cover Plate - 4 Module - Graphic Casual	4128	1/20
5763 81	Cover Plate - 6 Module - Graphic Casual	7474	1/5
5764 01	Cover Plate - 8 Module - Graphic Casual	8244	1/5
5758 89	Cover Plate - 2*4 Module - Graphic Casual	10380	1/10
5758 90	Cover Plate - 2*6 Module - Graphic Casual	12850	1/8

Silver Baroque Cover Plates with Overmoulded Frame

5758 53	Cover Plate - 1 Module - Silver Baroque	3346	1/5/30
5758 54	Cover Plate - 2 Module - Silver Baroque	3600	1/5/30
5758 55	Cover Plate - 3 Module - Silver Baroque	3868	1/0/20
5758 56	Cover Plate - 4 Module - Silver Baroque	4128	1/0/20
5758 57	Cover Plate - 6 Module - Silver Baroque	7474	1/0/5

* MRP - Maximum Retail Price Inclusive of all taxes including GST.

Bold Cat.Nos are products normally available with Legrand (India) Stockists. **Cat.Nos that are not bold** - delivery within 4 - 8 weeks from the date of order. **Bold packing quantity** is our mandatory packing. Orders to be placed by Legrand (India) Stockist in multiples of the same.

Arteor™

Square Cover Plates

Cat.Nos	Description	MRP* ₹ / Unit	Pack
5758 58	Cover Plate - 8 Module - Silver Baroque	8244	1/0/5
5758 59	Cover Plate - 2*4 Module - Silver Baroque	10380	1/0/10
5758 60	Cover Plate - 2*6 Module - Silver Baroque	12850	1/0/8
5758 61	Cover Plate - for Shaver Socket-3 Module - Silver Baroque	5284	1/5/50

Dark Baroque Cover Plates with Overmoulded Frame

5758 62	Cover Plate - 1 Module - Dark Baroque	3346	1/5/30
5758 63	Cover Plate - 2 Module - Dark Baroque	3600	1/5/30
5758 64	Cover Plate - 3 Module - Dark Baroque	3868	1/0/20
5758 65	Cover Plate - 4 Module - Dark Baroque	4128	1/0/20
5758 66	Cover Plate - 6 Module - Dark Baroque	7474	1/0/5
5758 67	Cover Plate - 8 Module - Dark Baroque	8244	1/0/5
5758 68	Cover Plate - 2*4 Module - Dark Baroque	10378	1/0/10
5758 69	Cover Plate - 2*6 Module - Dark Baroque	12850	1/0/8
5758 70	Cover Plate - for Shaver Socket-3 Module - Dark Baroque	5284	1/5/50

Metal Finish Cover Plates with Overmoulded Frame

Gold Brass Cover Plates with Overmoulded Frame

5762 90	Cover Plate - 1 Module - Gold Brass	4492	1/5/30
5763 10	Cover Plate - 2 Module - Gold Brass	4808	1/5/30
5763 30	Cover Plate - 3 Module - Gold Brass	5172	1/0/20
5763 50	Cover Plate - 4 Module - Gold Brass	5486	1/0/20
5763 80	Cover Plate - 6 Module - Gold Brass	9986	1/0/5
5764 00	Cover Plate - 8 Module - Gold Brass	10976	1/0/5

* MRP - Maximum Retail Price Inclusive of all taxes including GST.

Arteor™

Square Cover Plates

Cat.Nos	Description	MRP* ₹ / Unit	Pack
---------	-------------	------------------	------

Stainless Steel Cover Plates with Overmoulded Frame

5757 06	Cover Plate - 1 Module - Stainless Steel	4492	1/5/30
5757 16	Cover Plate - 2 Module - Stainless Steel	4808	1/5/30
5757 26	Cover Plate - 3 Module - Stainless Steel	5172	1/20
5757 36	Cover Plate - 4 Module - Stainless Steel	5486	1/20
5757 46	Cover Plate - 6 Module - Stainless Steel	9986	1/5
5757 56	Cover Plate - 8 Module - Stainless Steel	10976	1/0/5
5757 66	Cover Plate - 2*4 Module - Stainless Steel	13878	1/0/10
5757 76	Cover Plate - 2*6 Module - Stainless Steel	17104	1/8

Wood Cover Plates with Overmoulded Frame

5758 80	Cover Plate - 1 Module - Grey Oak	2632	1/5/30
5758 81	Cover Plate - 2 Module - Grey Oak	2792	1/5/30
5758 82	Cover Plate - 3 Module - Grey Oak	3446	1/20
5758 83	Cover Plate - 4 Module - Grey Oak	3820	1/20
5758 84	Cover Plate - 6 Module - Grey Oak	5672	1/5
5758 85	Cover Plate - 8 Module - Grey Oak	6822	1/5
5758 86	Cover Plate - 2*4 Module - Grey Oak	8102	1/10
5758 87	Cover Plate - 2*6 Module - Grey Oak	10856	1/8
5758 88	Cover Plate - for Shaver Socket-3 Module - Grey Oak	3364	1/5/50

Signature Cover Plates with Overmoulded Frame

5758 71	Cover Plate - 1 Module - Cube Plate	8610	1/5/30
5758 72	Cover Plate - 2 Module - Cube Plate	8764	1/5/30
5758 73	Cover Plate - 3 Module - Cube Plate	10024	1/20
5758 74	Cover Plate - 4 Module - Cube Plate	10358	1/20
5758 75	Cover Plate - 6 Module - Cube Plate	13492	1/5
5758 76	Cover Plate - 8 Module - Cube Plate	14158	1/5
5758 77	Cover Plate - 2*4 Module - Cube Plate	21154	1/10
5758 78	Cover Plate - 2*6 Module - Cube Plate	23434	1/8
5758 79	Cover Plate - for Shaver Socket-3 Module - Cube Plate	9610	1/5/50

Bold Cat.Nos are products normally available with Legrand (India) Stockists. Cat.Nos that are not bold - delivery within 4 - 8 weeks from the date of order. Bold packing quantity is our mandatory packing. Orders to be placed by Legrand (India) Stockist in multiples of the same.

Arteor™

Round Cover Plates

Cat.Nos	Description	MRP* ₹ / Unit	Pack
---------	-------------	------------------	------

Round Cover Plates with Metal Frame

Round - White Cover Plates with Metal Frame

5759 00	Cover Plate - 2 Module - White	498	10/100
5759 10	Cover Plate - 3 Module - White	526	10/100
5759 20	Cover Plate - 4 Module - White	554	5/50
5759 30	Cover Plate - 6 Module - White	1012	5/30
5765 80	Cover Plate - 8 Module - White	1118	5/30
5759 40	Cover Plate - 2*4 Module - White	1180	2/20
5759 50	Cover Plate - 2*6 Module - White	1720	2/16

Round - Pearl Aluminium Cover Plates with Metal Frame

5757 93	Cover Plate - 2 Module - Pearl Aluminium	668	10/100
5757 94	Cover Plate - 3 Module - Pearl Aluminium	722	10/100
5757 95	Cover Plate - 4 Module - Pearl Aluminium	812	5/50
5757 96	Cover Plate - 6 Module - Pearl Aluminium	1382	5/30
5757 97	Cover Plate - 8 Module - Pearl Aluminium	1532	5/30
5757 98	Cover Plate - 2*4 Module - Pearl Aluminium	1932	2/20
5757 99	Cover Plate - 2*6 Module - Pearl Aluminium	2518	2/16

Round - Graphite Cover Plates with Metal Frame

5758 03	Cover Plate - 2 Module - Graphite	668	10/100
5758 04	Cover Plate - 3 Module - Graphite	722	10/100
5758 05	Cover Plate - 4 Module - Graphite	812	5/50
5758 06	Cover Plate - 6 Module - Graphite	1376	5/30
5758 07	Cover Plate - 8 Module - Graphite	1532	5/30
5758 08	Cover Plate - 2*4 Module - Graphite	1932	2/20
5758 09	Cover Plate - 2*6 Module - Graphite	2518	2/16

Round - Magnesium Cover Plates with Metal Frame

5756 23	Cover Plate - 2 Module - Magnesium	668	10/100
5756 24	Cover Plate - 3 Module - Magnesium	722	10/100
5756 25	Cover Plate - 4 Module - Magnesium	812	5/50
5756 26	Cover Plate - 6 Module - Magnesium	1376	5/30
5756 27	Cover Plate - 8 Module - Magnesium	1528	5/30
5756 28	Cover Plate - 2*4 Module - Magnesium	1932	2/20
5756 29	Cover Plate - 2*6 Module - Magnesium	2518	2/16



5759 00



5759 10



5759 30



5759 80



5759 50



5759 41



5759 22

Arteor™

Round Cover Plates

Cat.Nos	Description	MRP* ₹ / Unit	Pack
---------	-------------	------------------	------

Round - Champagne Cover Plates with Metal Frame

5758 91	Cover Plate - 2 Module - Champagne	668	10/100
5758 92	Cover Plate - 3 Module - Champagne	722	10/100
5758 93	Cover Plate - 4 Module - Champagne	812	5/50
5758 94	Cover Plate - 6 Module - Champagne	1376	5/30
5758 95	Cover Plate - 8 Module - Champagne	1532	5/30
5758 96	Cover Plate - 2*4 Module - Champagne	1934	2/20
5758 97	Cover Plate - 2*6 Module - Champagne	2518	2/16

Round - Dark Bronze Cover Plates with Metal Frame

5756 93	Cover Plate - 2 Module - Dark Bronze	668	10/100
5756 94	Cover Plate - 3 Module - Dark Bronze	722	10/100
5756 95	Cover Plate - 4 Module - Dark Bronze	810	5/50
5756 96	Cover Plate - 6 Module - Dark Bronze	1376	5/30
5756 97	Cover Plate - 8 Module - Dark Bronze	1528	5/30
5756 98	Cover Plate - 2*4 Module - Dark Bronze	1932	2/20
5756 99	Cover Plate - 2*6 Module - Dark Bronze	2518	2/16

Round - Pearl Aluminium Cover Plates with Overmoulded frame

5759 01	Cover Plate - 2 Module - Pearl Aluminium	754	10/100
5759 11	Cover Plate - 3 Module - Pearl Aluminium	796	10/100
5759 21	Cover Plate - 4 Module - Pearl Aluminium	842	5/50
5759 31	Cover Plate - 6 Module - Pearl Aluminium	1532	5/30
5765 81	Cover Plate - 8 Module - Pearl Aluminium	1684	5/30
5759 41	Cover Plate - 2*4 Module - Pearl Aluminium	1768	2/20
5759 51	Cover Plate - 2*6 Module - Pearl Aluminium	2616	2/16

Round - Graphite Cover Plates with Overmoulded Frame

5759 02	Cover Plate - 2 Module - Graphite	754	10/100
5759 12	Cover Plate - 3 Module - Graphite	796	10/100
5759 22	Cover Plate - 4 Module - Graphite	842	5/50
5759 32	Cover Plate - 6 Module - Graphite	1532	5/30
5765 82	Cover Plate - 8 Module - Graphite	1684	5/30
5759 42	Cover Plate - 2*4 Module - Graphite	1768	2/20

* MRP - Maximum Retail Price Inclusive of all taxes including GST.

Bold Cat.Nos are products normally available with Legrand (India) Stockists. Cat.Nos that are not bold - delivery within 4 - 8 weeks from the date of order. Bold packing quantity is our mandatory packing. Orders to be placed by Legrand (India) Stockist in multiples of the same.

Arteor™

Round Cover Plates

Cat.Nos	Description	MRP* ₹ / Unit	Pack
---------	-------------	------------------	------

Round - Graphite Cover Plates with Overmoulded Frame

5759 52	Cover Plate - 2*6 Module - Graphite	2616	2/16
---------	-------------------------------------	------	------

Round - Magnesium Cover Plates with Overmoulded Frame

5768 41	Cover Plate - 2 Module - Magnesium	754	10/100
5768 42	Cover Plate - 3 Module - Magnesium	796	10/100
5768 43	Cover Plate - 4 Module - Magnesium	842	5/50
5768 44	Cover Plate - 6 Module - Magnesium	1532	5/30
5768 45	Cover Plate - 8 Module - Magnesium	1684	5/30
5768 46	Cover Plate - 2*4 Module - Magnesium	1768	2/20
5768 47	Cover Plate - 2*6 Module - Magnesium	2616	2/16

Round - Champagne Cover Plates with Overmoulded Frame

5768 48	Cover Plate - 2 Module - Champagne	754	10/100
5768 49	Cover Plate - 3 Module - Champagne	796	10/100
5768 50	Cover Plate - 4 Module - Champagne	842	5/50
5768 51	Cover Plate - 6 Module - Champagne	1532	5/30
5768 52	Cover Plate - 8 Module - Champagne	1684	5/30
5768 53	Cover Plate - 2*4 Module - Champagne	1768	2/20
5768 54	Cover Plate - 2*6 Module - Champagne	2616	2/16

Round - Dark Bronze Cover Plates with Overmoulded Frame

5768 55	Cover Plate - 2 Module - Dark Bronze	754	10/100
5768 56	Cover Plate - 3 Module - Dark Bronze	796	10/100
5768 57	Cover Plate - 4 Module - Dark Bronze	842	5/50
5768 58	Cover Plate - 6 Module - Dark Bronze	1532	5/30
5768 59	Cover Plate - 8 Module - Dark Bronze	1684	5/30
5768 60	Cover Plate - 2*4 Module - Dark Bronze	1768	2/20
5768 61	Cover Plate - 2*6 Module - Dark Bronze	2616	2/16

Round Mirror Finish Cover Plates

Round - Mirror Black Cover Plates with Overmoulded Frame

5759 03	Cover Plate - 2 Module - Mirror Black	3250	1/5/30
5759 13	Cover Plate - 3 Module - Mirror Black	3486	1/20

* MRP - Maximum Retail Price Inclusive of all taxes including GST.

Arteor™

Round Cover Plates

Cat.Nos	Description	MRP* ₹ / Unit	Pack
---------	-------------	------------------	------

Round Mirror Finish Cover Plates

Round - Mirror Black Cover Plates with Overmoulded Frame

5759 23	Cover Plate - 4 Module - Mirror Black	3708	1/20
5759 33	Cover Plate - 6 Module - Mirror Black	6708	1/5
5765 83	Cover Plate - 8 Module - Mirror Black	7408	1/5
5759 43	Cover Plate - 2*4 Module - Mirror Black	8732	1/10
5759 53	Cover Plate - 2*6 Module - Mirror Black	11544	1/8

Round - Mirror White Cover Plates with Overmoulded Frame

5759 04	Cover Plate - 2 Module - Mirror White	3250	1/5/30
5759 14	Cover Plate - 3 Module - Mirror White	3486	1/20
5759 24	Cover Plate - 4 Module - Mirror White	3708	1/20
5759 34	Cover Plate - 6 Module - Mirror White	6708	1/5
5765 84	Cover Plate - 8 Module - Mirror White	7408	1/5
5759 44	Cover Plate - 2*4 Module - Mirror White	8914	1/10
5759 54	Cover Plate - 2*6 Module - Mirror White	11544	1/8

Round - Green Apple Cover Plates with Overmoulded Frame

5768 62	Cover Plate - 2 Module - Green Apple	3250	1/5/30
5768 63	Cover Plate - 3 Module - Green Apple	3486	1/20
5768 64	Cover Plate - 4 Module - Green Apple	3708	1/20
5768 65	Cover Plate - 6 Module - Green Apple	6706	1/5
5768 66	Cover Plate - 8 Module - Green Apple	7408	1/5
5768 67	Cover Plate - 2*4 Module - Green Apple	8910	1/10
5768 68	Cover Plate - 2*6 Module - Green Apple	11544	1/8

Round - Graphic Casual Cover Plates with Overmoulded Frame

5763 01	Cover Plate - 2 Module - Graphic Casual	3972	1/5/30
---------	---	------	--------

Bold Cat.Nos are products normally available with Legrand (India) Stockists. **Cat.Nos** that are not bold - delivery within 4 - 8 weeks from the date of order. **Bold packing quantity** is our mandatory packing. Orders to be placed by Legrand (India) Stockist in multiples of the same.

Arteor™

Round Cover Plates

Cat.Nos	Description	MRP* ₹ / Unit	Pack
---------	-------------	------------------	------

Round - Graphic Casual Cover Plates with Overmoulded Frame

5763 21	Cover Plate - 3 Module - Graphic Casual	4252	1/20
5763 41	Cover Plate - 4 Module - Graphic Casual	4538	1/20
5763 61	Cover Plate - 6 Module - Graphic Casual	8224	1/5
5763 91	Cover Plate - 8 Module - Graphic Casual	9056	1/5
5768 97	Cover Plate - 2*4 Module - Graphic Casual	10864	1/10
5768 98	Cover Plate - 2*6 Module - Graphic Casual	14134	1/8

Round - Silver Baroque Cover Plates with Overmoulded Frame

5768 69	Cover Plate - 2 Module - Silver Baroque	3972	1/5/30
5768 70	Cover Plate - 3 Module - Silver Baroque	4252	1/20
5768 71	Cover Plate - 4 Module - Silver Baroque	4538	1/20
5768 72	Cover Plate - 6 Module - Silver Baroque	8224	1/5
5768 73	Cover Plate - 8 Module - Silver Baroque	9056	1/5
5768 74	Cover Plate - 2*4 Module - Silver Baroque	10864	1/10
5768 75	Cover Plate - 2*6 Module - Silver Baroque	14134	1/8

Round - Dark Baroque Cover Plates with Overmoulded Frame

5768 76	Cover Plate - 2 Module - Dark Baroque	3972	1/5/30
5768 77	Cover Plate - 3 Module - Dark Baroque	4252	1/20
5768 78	Cover Plate - 4 Module - Dark Baroque	4538	1/20
5768 79	Cover Plate - 6 Module - Dark Baroque	8224	1/5
5768 80	Cover Plate - 8 Module - Dark Baroque	9056	1/5
5768 81	Cover Plate - 2*4 Module - Dark Baroque	10864	1/10
5768 82	Cover Plate - 2*6 Module - Dark Baroque	14134	1/8

Arteor™

Round Cover Plates

Cat.Nos	Description	MRP* ₹ / Unit	Pack
---------	-------------	------------------	------

Round - Gold Brass Cover Plates with Overmoulded Frame

5763 00	Cover Plate - 2 Module - Gold Brass	5300	1/5/30
5763 20	Cover Plate - 3 Module - Gold Brass	5660	1/20
5763 40	Cover Plate - 4 Module - Gold Brass	6038	1/20
5763 60	Cover Plate - 6 Module - Gold Brass	10970	1/5
5763 90	Cover Plate - 8 Module - Gold Brass	12086	1/5

Round - Stainless Steel Cover Plates with Overmoulded Frame

5759 06	Cover Plate - 2 Module - Stainless Steel	5300	1/5/30
5759 16	Cover Plate - 3 Module - Stainless Steel	5660	1/20
5759 26	Cover Plate - 4 Module - Stainless Steel	6038	1/20
5759 36	Cover Plate - 6 Module - Stainless Steel	10970	1/5
5765 86	Cover Plate - 8 Module - Stainless Steel	12086	1/5
5759 46	Cover Plate - 2*4 Module - Stainless Steel	15280	1/10
5759 56	Cover Plate - 2*6 Module - Stainless Steel	18808	1/8

Round - Wood Cover Plates with Overmoulded Frame

5768 90	Cover Plate - 2 Module - Grey Oak	2790	1/5/30
5768 91	Cover Plate - 3 Module - Grey Oak	4126	1/20
5768 92	Cover Plate - 4 Module - Grey Oak	4280	1/20
5768 93	Cover Plate - 6 Module - Grey Oak	6076	1/5
5768 94	Cover Plate - 8 Module - Grey Oak	7404	1/5
5768 95	Cover Plate - 2*4 Module - Grey Oak	7912	1/10
5768 96	Cover Plate - 2*6 Module - Grey Oak	10124	1/8

* MRP - Maximum Retail Price Inclusive of all taxes including GST.

Bold Cat.Nos are products normally available with Legrand (India) Stockists. **Cat.Nos that are not bold** - delivery within 4 - 8 weeks from the date of order. **Bold packing quantity** is our mandatory packing. Orders to be placed by Legrand (India) Stockist in multiples of the same.

Arteor™

Round Cover Plates

Cat.Nos	Description	MRP* ₹ / Unit	Pack
Round - Signature Cover Plates with Overmoulded Frame			
5768 83	Cover Plate - 2 Module - Cube Plate	8764	1/5/30
5768 84	Cover Plate - 3 Module - Cube Plate	10652	1/20
5768 85	Cover Plate - 4 Module - Cube Plate	10848	1/20
5768 86	Cover Plate - 6 Module - Cube Plate	13886	1/5
5768 87	Cover Plate - 8 Module - Cube Plate	14732	1/5
5768 88	Cover Plate - 2*4 Module - Cube Plate	20496	1/10
5768 89	Cover Plate - 2*6 Module - Cube Plate	23190	1/8



5768 84

Accessories

Plastic Surface Boxes

5734 91	Plastic Surface Box - 1/2 Module	144	55
5735 20	Plastic Surface Box - 3 Module	172	42
5735 70	Plastic Surface Box - 4 Module	204	27
5735 71	Plastic Surface Box - 6 Module	254	20
5723 94	Plastic Surface Box - 8 Module	286	20
5735 74	Plastic Surface Box - 2*4 Module	350	10
5735 72	Plastic Surface Box - 12/16 Module	900	11
5735 73	Plastic Surface Box - 18/24 Module	952	8



5735 70

* MRP - Maximum Retail Price Inclusive of all taxes including GST.

Arteor™

Mounting Boxes

Cat.Nos	Description	MRP* ₹ / Unit	Pack
Metal Flush Boxes			
6890 07	Metal Flush Box - 1/2 Module	170	40
6890 08	Metal Flush Box - 3 Module	170	40
6890 09	Metal Flush Box - 4 Module	226	40
6890 10	Metal Flush Box - 6 Module	358	40
6890 42	Metal Flush Box - 8 Module	416	40
6890 31	Metal Flush Box - 2*4 Module	414	20
6890 11	Metal Flush Box - 12/16 Module	624	10
6890 12	Metal Flush Box - 18/24 Module	788	10



6890 08



6890 09



6890 12



6846 38



6806 12



6806 13

IP 55 Plexo Box & Accessories

6846 38	Grey Plexo Box & Adaptor with Transparent Flap-3 Module-IP 66	5620	1
---------	---	------	---

IP 55 Plexo Box with PVC Membrane

6806 11	Grey Plexo Box & Adaptor with PVC Membrane-1 Module	1240	10
6806 12	Grey Plexo Box & Adaptor with PVC Membrane-2 Module	1266	10
6806 13	Grey Plexo Box & Adaptor with PVC Membrane-3 Module	1684	10
6806 14	Grey Plexo Box & Adaptor with PVC Membrane-4 Module	2526	5

Bold Cat.Nos are products normally available with Legrand (India) Stockists. **Cat.Nos** that are not bold - delivery within 4 - 8 weeks from the date of order. **Bold packing quantity** is our mandatory packing. Orders to be placed by Legrand (India) Stockist in multiples of the same.

Arteor™

Mounting Boxes

Cat.Nos	Description	MRP* ₹ / Unit	Pack
IP 55 Plexo Box with PVC Membrane			
6806 19	Grey Plexo Box & Adaptor with PVC Membrane-2 Row*4 Module	4096	5
6806 33	Grey Plexo Flush Adaptor with Membrane-3 Module Arteor Box	1350	20

Arteor™

Guarantee

- The Company, at its discretion, will replace products if they have any manufacturing defect within 10 years for switches (without LED lamp) and power sockets. For all other **Arteor™** wiring accessories the guarantee will be 2 years.
- The above guarantee is applicable when the devices are used in Legrand metal flush boxes. Otherwise the guarantee period will be reduced by 50%.
- The guarantee is only applicable when the products are installed as per the Company's instructions and not tampered in any manner.
- The guarantee states the Company's entire liability. It does not extend to cover consequential loss or damage or installation costs arising from defective products.

Our switches are compliant with revised BIS standard (IS 3854:2023) requirements. Also, our switches are covered additionally for use on Self-Ballasted Lamp (SBL) loads.

SBL power rating as per IS3854:2023

Switch Rating	6A, 230V~	10A, 230V~	16A, 230V~	20A, 230V~
SBL power (Watt)	100 W	100 W	200 W	250 W

* MRP - Maximum Retail Price Inclusive of all taxes including GST.

Bold Cat.Nos are products normally available with Legrand (India) Stockists. **Cat.Nos that are not bold** - delivery within 4 - 8 weeks from the date of order. **Bold packing quantity** is our mandatory packing. Orders to be placed by Legrand (India) Stockist in multiples of the same.

ARTEOR™ IoT

Smart Homes, Smarter Convenience

Arteor™ IoT enhances the Arteor wiring device range with wireless smart controls for modern connected homes. Using Zigbee 3.0, etc technologies, it enables intelligent lighting control, curtain control, fan control, scenario management energy monitoring, scheduling.

Features

- Wireless smart controls including dimmers and scenario switches allow you to control everything wirelessly
- Voice assistant compatibility with Alexa, Google Home, and Apple HomeKit
- Home+Control app integration for setup, monitoring, and scene management

Benefits

- Adds smart, intelligent automation to premium Arteor installations
- Simplifies upgrades with wireless installation and mesh connectivity
- Enhances everyday convenience through manual, voice and Legrand Home+ Control application

Scan to know more about
the product.





THE HOME + CONTROL APP FOR SMARTPHONE OR TABLET

The app on the smartphone or tablet opens up new options: monitoring of instantaneous power consumption and control over various functions when the user is out and about.



LOCAL CONTROL GUARANTEED

Of course, all functions can still be used in the traditional way via switches on the wall. If furniture needs to be rearranged or small children need to be able to reach a switch, the wireless switches can be repositioned easily at any time.



**Home +
Control App**

iPhone, iPod and iPad are registered trademarks of Apple Inc, registered in the US and other countries. HomeKit is a trademark of Apple Inc. App store is a service mark of Apple Inc., Google, Android, Google Play, and the Google Play logo are trademarks of Google LLC. Amazon, Alexa and all related logos are trademarks of Amazon.com, Inc. or its affiliates.

Product Range



**DIMMER WITH
NEUTRAL 1M
150W**



**4 SCENARIO
CONTROL
WIRELESS SW**



**WIRELESS
2 GANG
SWITCH**



**AUXILIARY
WIRELESS
SWITCH**



**SHUTTER
MICRO
MODULE**



**PORTABLE
REMOTE**

CX³

Smart Comfort & Control from your Electrical Panel

CX³ combines smart electrical panel solutions with the Home + Control app to provide a complete system for managing residential electrical functions from anywhere. Designed for homes as well as multi-dwelling buildings, it enables convenient control of lighting, power, and other loads while delivering enhanced comfort and connectivity in everyday living.

Features

- Centralised control of lighting, power via app
- Compatible with major voice assistants
- Scalable solution for homes and multi-dwelling buildings
- Scene and schedule-based automation

Benefits

- Enables remote and voice control for enhanced home comfort
- Simplifies daily routines with personalised automation
- Adds value with smart, connected home infrastructure
- Supports flexible management for individual homes or apartments

Scan to know more about
the product.





WORKS WITH
alexia

works with the
Google Assistant

Works with
Apple HomeKit



Gateway module



Smart Contactor



Smart Latching Relay



Energy Meter



Remote Control



Voice Control



Ease of Scheduling



Smart Energy Management

Arteor™ IoT

Connected Home - White Mechanism

Cat.Nos	Description	MRP* ₹ / Unit	Pack
---------	-------------	------------------	------

Connected Light Switches

5742 01	Connected Switch - with Neutral - Wired - 1 Module	11626	1/0/24
5743 40	Connected Switch Dimmer - with Neutral - 150 Watts - 1 Module	13354	1/0/24

Connected Outlets

5742 00	16A - Connected Socket Module - 1 Module	13242	1/0/12
---------	--	-------	--------

Connected Curtain/Roller Blind Switches

5742 04	Connected Curtain/Roller Blind Switch - Wired - 1 Module	14144	1/0/24
---------	--	-------	--------

Connected Step Fan Controller

5742 48	Connected Step Fan Controller - with Neutral -100W - 2 Module	9794	1/20
---------	---	------	------

Connected Gateway Pack

5742 09	Connected Gateway + Master Home/Away Wireless Switch - Wired - 2 Module	28186	1/0/4
---------	---	-------	-------

Wireless Control Switch

5742 05	1 Gang - Wireless Switch - 2 Module	6036	1/0/10
5742 44	2 Gang - Wireless Switch - 2 Module	6956	1/0/10
5742 07	Curtain/Roller Blind Wireless Switch - 2 Module	6962	1/0/10

Wireless Scenario Control Switch

5742 06	Home/Away Wireless Master Switch - 2 Module	7064	1/0/10
5742 08	Wake Up/Sleep Wireless Scenario Control Switch - 2 Module	7064	1/0/10
5743 12	Wireless 4 Scenario Control Switch - 2 Module	8822	1/0/10

Connected Home- Magnesium Mechanism Connected Light Switches

5742 20	Connected Switch - with Neutral - Wired - 1 Module	13380	1/0/24
5743 42	Connected Switch Dimmer - with Neutral - 150 Watts - 1 Module	15354	1/0/24

Connected Outlets

5742 28	16A - Connected Socket Module - 1 Module	15386	1/0/12
---------	--	-------	--------

* MRP - Maximum Retail Price Inclusive of all taxes including GST.
Red Cat.Nos - new products

Arteor™ IoT

Connected Home - Magnesium Mechanism

Cat.Nos	Description	MRP* ₹ / Unit	Pack
---------	-------------	------------------	------

Connected Curtain/Roller Blind Switches

5742 22	Connected Curtain/Roller Blind Switch - Wired - 1 Module	16258	1/0/24
---------	--	-------	--------

Connected Step Fan Controller

5742 50	Connected Step Fan Controller - with Neutral -100W - 2 Module	11262	1/20
---------	---	-------	------

Connected Gateway Pack

5742 27	Connected Gateway + Master Home/Away Wireless Switch - Wired - 2 Module	32410	1/0/4
---------	---	-------	-------

Wireless Control Switch

5742 23	1 Gang - Wireless Switch - 2 Module	7016	1/0/10
5742 46	2 Gang - Wireless Switch - 2 Module	7994	1/0/10
5742 25	Curtain/Roller Blind Wireless Switch - 2 Module	8006	1/0/10

Connected Wireless Scene Switches

5742 24	Home/Away Wireless Master Switch - 2 Module	8130	1/0/10
5742 26	Wake Up/Sleep Wireless Scenario Control Switch - 2 Module	8130	1/0/10
5743 14	Wireless 4 Scenario Control Switch - 2 Module	10148	1/0/10

Connected Home - Champagne Mechanism Connected Light Switches

5742 29	Connected Switch - with Neutral - Wired - 1 Module	13380	1/0/24
5743 43	Connected Switch Dimmer - with Neutral - 150 Watts - 1 Module	15354	1/0/24

Connected Outlets

5742 37	16A - Connected Socket Module - 1 Module	15386	1/0/12
---------	--	-------	--------

Connected Curtain/Roller Blind Switches

5742 31	Connected Curtain/Roller Blind Switch - Wired - 1 Module	16258	1/0/24
---------	--	-------	--------

Connected Step Fan Controller

5742 51	Connected Step Fan Controller - with Neutral -100W - 2 Module	11262	1/5/50
---------	---	-------	--------

Connected Gateway Pack

5742 36	Connected Gateway + Master Home/Away Wireless Switch - Wired - 2 Module	32410	1/0/4
---------	---	-------	-------

Bold Cat.Nos are products normally available with Legrand (India) Stockists. Cat.Nos that are not bold - delivery within 4 - 8 weeks from the date of order. Bold packing quantity is our mandatory packing. Orders to be placed by Legrand (India) Stockist in multiples of the same.

Arteor™ IoT

Connected Home - Champagne Mechanism

Cat.Nos	Description	MRP* ₹ / Unit	Pack
---------	-------------	------------------	------

Wireless Control Switch

5742 32	1 Gang - Wireless Switch - 2 Module	6948	1/0/10
5742 47	2 Gang - Wireless Switch - 2 Module	7994	1/0/10
5742 34	Curtain/Roller Blind Wireless Switch - 2 Module	8006	1/0/10



5742 34

Wireless Scenario Control Switch

5742 33	Home/Away Wireless Master Switch - 2 Module	8130	1/0/10
5742 35	Wake Up/Sleep Wireless Scenario Control Switch - 2 Module	8130	1/0/10
5743 15	Wireless 4 Scenario Control Switch - 2 Module	10148	1/0/10



5742 35

Micro Module Switch & Connected Accessories

5742 43	Micro Module Switch - with Neutral - Black	9732	1/0/22
0676 97	Shutter Micromodule	12624	1
0676 94	Wireless Switch - On/Off Module for Mechanical Switch - (Auxiliary) - Black	11810	1
0676 95	Portable Remote - Black	15568	1

Cover plates

White Cover Plates with Overmoulded Frame

5758 98	Cover Plate + Support Frame - 1 Module - White	446	10/100
5758 99	Cover Plate + Support Frame - 2 Module - White	460	10/100
5759 60	Cover Plate + Support Frame - 3 Module - White	534	10/100
5759 65	Cover Plate + Support Frame - 4 Module - White	614	5/50
5759 94	Cover Plate + Support Frame - 6 Module - White	844	5/30
5759 95	Cover Plate + Support Frame - 8 Module - White	1000	5/30
5759 96	Cover Plate + Support Frame - 2*4 Module - White	1460	2/20
5759 97	Cover Plate + Support Frame - 2*6 Module - White	1938	2/16
5759 98	Cover Plate + Support Frame - 2*8 Module - White	2130	2/16
5759 99	Cover Plate + Support Frame - 3*6 Module - White	2512	2/16



5758 99



5759 65



5759 94

Pearl Aluminium Cover Plates with Overmoulded Frame

5757 01	Cover Plate + Support Frame - 1 Module - Pearl Aluminium	540	10/100
5757 11	Cover Plate + Support Frame - 2 Module - Pearl Aluminium	572	10/100

* MRP - Maximum Retail Price Inclusive of all taxes including GST.
Red Cat.Nos - new products

Arteor™ IoT

Cover Plates

Cat.Nos	Description	MRP* ₹ / Unit	Pack
---------	-------------	------------------	------

Pearl Aluminium Cover Plates with Overmoulded Frame

5757 21	Cover Plate + Support Frame - 3 Module - Pearl Aluminium	608	10/100
5757 31	Cover Plate + Support Frame - 4 Module - Pearl Aluminium	690	5/50
5757 41	Cover Plate + Support Frame - 6 Module - Pearl Aluminium	1172	5/30
5757 51	Cover Plate + Support Frame - 8 Module - Pearl Aluminium	1302	5/30
5757 61	Cover Plate + Support Frame - 2*4 Module - Pearl Aluminium	1652	2/20
5757 71	Cover Plate + Support Frame - 2*6 Module - Pearl Aluminium	2146	2/16
5757 81	Cover Plate + Support Frame - 2*8 Module - Pearl Aluminium	2438	2/16
5757 91	Cover Plate + Support Frame - 3*6 Module - Pearl Aluminium	2852	2/12



5757 21



5757 61

Graphite Cover Plates with Overmoulded Frame

5757 02	Cover Plate + Support Frame - 1 Module - Graphite	540	10/100
5757 12	Cover Plate + Support Frame - 2 Module - Graphite	572	10/100
5757 22	Cover Plate + Support Frame - 3 Module - Graphite	608	10/100
5757 32	Cover Plate + Support Frame - 4 Module - Graphite	690	5/50
5757 42	Cover Plate + Support Frame - 6 Module - Graphite	1172	5/30
5757 52	Cover Plate + Support Frame - 8 Module - Graphite	1302	5/30
5757 62	Cover Plate + Support Frame - 2*4 Module - Graphite	1652	2/20
5757 72	Cover Plate + Support Frame - 2*6 Module - Graphite	2146	2/16
5757 82	Cover Plate + Support Frame - 2*8 Module - Graphite	2438	2/16
5757 92	Cover Plate + Support Frame - 3*6 Module - Graphite	2852	2/12



5757 22



5757 42

Magnesium Cover Plates with Overmoulded Frame

5758 11	Cover Plate + Support Frame - 1 Module - Magnesium	540	10/100
5758 12	Cover Plate + Support Frame - 2 Module - Magnesium	572	10/100

Bold Cat.Nos are products normally available with Legrand (India) Stockists. Cat.Nos that are not bold - delivery within 4 - 8 weeks from the date of order. Bold packing quantity is our mandatory packing. Orders to be placed by Legrand (India) Stockist in multiples of the same.

Arteor™ IoT

Cover Plates

Cat.Nos	Description	MRP* ₹ / Unit	Pack
---------	-------------	------------------	------

Magnesium Cover Plates with Overmoulded Frame

5758 13	Cover Plate + Support Frame - 3 Module - Magnesium	608	10/100
5758 14	Cover Plate + Support Frame - 4 Module - Magnesium	690	5/50
5758 15	Cover Plate + Support Frame - 6 Module - Magnesium	1172	5/30
5758 16	Cover Plate + Support Frame - 8 Module - Magnesium	1302	5/30
5758 17	Cover Plate + Support Frame - 2*4 Module - Magnesium	1652	2/20
5758 18	Cover Plate + Support Frame - 2*6 Module - Magnesium	2146	2/16
5758 19	Cover Plate + Support Frame - 2*8 Module - Magnesium	2438	2/16
5758 20	Cover Plate + Support Frame - 3*6 Module - Magnesium	2852	2/12

Champagne Cover Plates with Overmoulded Frame

5758 22	Cover Plate + Support Frame - 1 Module - Champagne	540	10/100
5758 23	Cover Plate + Support Frame - 2 Module - Champagne	572	10/100
5758 24	Cover Plate + Support Frame - 3 Module - Champagne	608	10/100
5758 25	Cover Plate + Support Frame - 4 Module - Champagne	690	5/50
5758 26	Cover Plate + Support Frame - 6 Module - Champagne	1172	5/30
5758 27	Cover Plate + Support Frame - 8 Module - Champagne	1302	5/30
5758 28	Cover Plate + Support Frame - 2*4 Module - Champagne	1652	2/20
5758 29	Cover Plate + Support Frame - 2*6 Module - Champagne	2146	2/16
5758 30	Cover Plate + Support Frame - 2*8 Module - Champagne	2438	2/16
5758 31	Cover Plate + Support Frame - 3*6 Module - Champagne	2852	2/12

Dark Bronze Cover Plates with Overmoulded Frame

5758 33	Cover Plate + Support Frame - 1 Module - Dark Bronze	540	10/100
---------	--	-----	--------

Arteor™ IoT

Cover Plates

Cat.Nos	Description	MRP* ₹ / Unit	Pack
---------	-------------	------------------	------

Dark Bronze Cover Plates with Overmoulded Frame

5758 34	Cover Plate + Support Frame - 2 Module - Dark Bronze	572	10/100
5758 35	Cover Plate + Support Frame - 3 Module - Dark Bronze	608	10/100
5758 36	Cover Plate + Support Frame - 4 Module - Dark Bronze	690	5/50
5758 37	Cover Plate + Support Frame - 6 Module - Dark Bronze	1172	5/30
5758 38	Cover Plate + Support Frame - 8 Module - Dark Bronze	1302	5/30
5758 39	Cover Plate + Support Frame - 2*4 Module - Dark Bronze	1652	2/20
5758 40	Cover Plate + Support Frame - 2*6 Module - Dark Bronze	2146	2/16
5758 41	Cover Plate + Support Frame - 2*8 Module - Dark Bronze	2438	2/16
5758 42	Cover Plate + Support Frame - 3*6 Module - Dark Bronze	2852	2/12

Mirror Finish Cover Plates With Overmoulded Frame

Mirror Black Cover Plates With Overmoulded Frame

5757 03	Cover Plate + Support Frame - 1 Module - Mirror Black	2756	1/5/30
5757 13	Cover Plate + Support Frame - 2 Module - Mirror Black	2948	1/5/30
5757 23	Cover Plate + Support Frame - 3 Module - Mirror Black	3158	1/20
5757 33	Cover Plate + Support Frame - 4 Module - Mirror Black	3354	1/20
5757 43	Cover Plate + Support Frame - 6 Module - Mirror Black	6106	1/5
5757 53	Cover Plate + Support Frame - 8 Module - Mirror Black	6726	1/5
5757 63	Cover Plate + Support Frame - 2*4 Module - Mirror Black	8524	1/10
5757 73	Cover Plate + Support Frame - 2*6 Module - Mirror Black	10486	1/8

Mirror White Cover Plates with Overmoulded Frame

5757 04	Cover Plate + Support Frame - 1 Module - Mirror White	2756	1/5/30
5757 14	Cover Plate + Support Frame - 2 Module - Mirror White	2948	1/5/30
5757 24	Cover Plate + Support Frame - 3 Module - Mirror White	3158	1/20

* MRP - Maximum Retail Price Inclusive of all taxes including GST.

Bold Cat.Nos are products normally available with Legrand (India) Stockists. Cat.Nos that are not bold - delivery within 4 - 8 weeks from the date of order. Bold packing quantity is our mandatory packing. Orders to be placed by Legrand (India) Stockist in multiples of the same.

Arteor™ IoT

Cover Plates

Cat.Nos	Description	MRP* ₹ / Unit	Pack
---------	-------------	------------------	------

Mirror White Cover Plates with Overmoulded Frame

5757 34	Cover Plate + Support Frame - 4 Module - Mirror White	3354	1/20
5757 44	Cover Plate + Support Frame - 6 Module - Mirror White	6106	1/5
5757 54	Cover Plate + Support Frame - 8 Module - Mirror White	6726	1/5
5757 64	Cover Plate + Support Frame - 2*4 Module - Mirror White	8680	1/10
5757 74	Cover Plate + Support Frame - 2*6 Module - Mirror White	10486	1/8



5757 74

Mirror Green Apple Cover Plates with Overmoulded Frame

5758 44	Cover Plate + Support Frame - 1 Module - Green Apple	2756	1/5/30
5758 45	Cover Plate + Support Frame - 2 Module - Green Apple	2948	1/5/30
5758 46	Cover Plate + Support Frame - 3 Module - Green Apple	3158	1/20
5758 47	Cover Plate + Support Frame - 4 Module - Green Apple	3354	1/20
5758 48	Cover Plate + Support Frame - 6 Module - Green Apple	6106	1/5
5758 49	Cover Plate + Support Frame - 8 Module - Green Apple	6726	1/5
5758 50	Cover Plate + Support Frame - 2*4 Module - Green Apple	8678	1/10
5758 51	Cover Plate + Support Frame - 2*6 Module - Green Apple	10486	1/8



5758 45

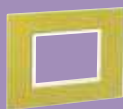

5758 46

Graphic Casual Cover Plates with Overmoulded Frame

5762 91	Cover Plate + Support Frame - 1 Module - Graphic Casual	3346	1/5/30
5763 11	Cover Plate + Support Frame - 2 Module - Graphic Casual	3600	1/5/30
5763 31	Cover Plate + Support Frame - 3 Module - Graphic Casual	3868	1/20
5763 51	Cover Plate + Support Frame - 4 Module - Graphic Casual	4128	1/20
5763 81	Cover Plate + Support Frame - 6 Module - Graphic Casual	7474	1/5
5764 01	Cover Plate + Support Frame - 8 Module - Graphic Casual	8244	1/5
5758 89	Cover Plate + Support Frame - 2*4 Module - Graphic Casual	10380	1/10



5763 31

Arteor™ IoT

Cover Plates

Cat.Nos	Description	MRP* ₹ / Unit	Pack
---------	-------------	------------------	------

Graphic Casual Cover Plates with Overmoulded Frame

5758 90	Cover Plate + Support Frame - 2*6 Module - Graphic Casual	12850	1/8
---------	---	-------	-----

Silver Baroque Cover Plates with Overmoulded Frame

5758 53	Cover Plate + Support Frame - 1 Module - Silver Baroque	3346	1/5/30
5758 54	Cover Plate + Support Frame - 2 Module - Silver Baroque	3600	1/5/30
5758 55	Cover Plate + Support Frame - 3 Module - Silver Baroque	3868	1/20
5758 56	Cover Plate + Support Frame - 4 Module - Silver Baroque	4128	1/20
5758 57	Cover Plate + Support Frame - 6 Module - Silver Baroque	7474	1/5
5758 58	Cover Plate + Support Frame - 8 Module - Silver Baroque	8244	1/5
5758 59	Cover Plate + Support Frame - 2*4 Module - Silver Baroque	10380	1/10
5758 60	Cover Plate + Support Frame - 2*6 Module - Silver Baroque	12850	1/8



5758 54



5758 55

Dark Baroque Cover Plates with Overmoulded Frame

5758 62	Cover Plate + Support Frame - 1 Module - Dark Baroque	3346	1/5/30
5758 63	Cover Plate + Support Frame - 2 Module - Dark Baroque	3600	1/5/30
5758 64	Cover Plate + Support Frame - 3 Module - Dark Baroque	3868	1/20
5758 65	Cover Plate + Support Frame - 4 Module - Dark Baroque	4128	1/20
5758 66	Cover Plate + Support Frame - 6 Module - Dark Baroque	7474	1/5
5758 67	Cover Plate + Support Frame - 8 Module - Dark Baroque	8244	1/5
5758 68	Cover Plate + Support Frame - 2*4 Module - Dark Baroque	10378	1/10
5758 69	Cover Plate + Support Frame - 2*6 Module - Dark Baroque	12850	1/8



5758 63



5758 64

Metal Finish Cover Plates with Overmoulded Frame Gold Brass Cover Plates with Overmoulded Frame

5762 90	Cover Plate + Support Frame - 1 Module - Gold Brass	4492	1/5/30
5763 10	Cover Plate + Support Frame - 2 Module - Gold Brass	4808	1/5/30



5762 90

* MRP - Maximum Retail Price Inclusive of all taxes including GST.

Bold Cat.Nos are products normally available with Legrand (India) Stockists. Cat.Nos that are not bold - delivery within 4 - 8 weeks from the date of order. Bold packing quantity is our mandatory packing. Orders to be placed by Legrand (India) Stockist in multiples of the same.

Arteor™ IoT

Cover Plates

Cat.Nos	Description	MRP* ₹ / Unit	Pack
---------	-------------	------------------	------

Metal Finish Cover Plates with Overmoulded Frame

Gold Brass Cover Plates with Overmoulded Frame

5763 30	Cover Plate + Support Frame - 3 Module - Gold Brass	5172	1/20
5763 50	Cover Plate + Support Frame - 4 Module - Gold Brass	5486	1/20
5763 80	Cover Plate + Support Frame - 6 Module - Gold Brass	9986	1/5
5764 00	Cover Plate + Support Frame - 8 Module - Gold Brass	10976	1/5



5763 30

Stainless Steel Cover Plates with Overmoulded Frame

5757 06	Cover Plate + Support Frame - 1 Module - Stainless Steel	4492	1/5/30
5757 16	Cover Plate + Support Frame - 2 Module - Stainless Steel	4808	1/5/30
5757 26	Cover Plate + Support Frame - 3 Module - Stainless Steel	5172	1/20
5757 36	Cover Plate + Support Frame - 4 Module - Stainless Steel	5486	1/20
5757 46	Cover Plate + Support Frame - 6 Module - Stainless Steel	9986	1/5
5757 66	Cover Plate + Support Frame - 2*4 Module - Stainless Steel	13878	1/10
5757 56	Cover Plate + Support Frame - 8 Module - Stainless Steel	10976	1/5
5757 76	Cover Plate + Support Frame - 2*6 Module - Stainless Steel	17104	1/8



5757 16

Wood Cover Plates with Overmoulded Frame

5758 80	Cover Plate + Support Frame - 1 Module - Grey Oak	2632	1/5/30
5758 81	Cover Plate + Support Frame - 2 Module - Grey Oak	2792	1/5/30
5758 82	Cover Plate + Support Frame - 3 Module - Grey Oak	3446	1/20



5758 81

* MRP - Maximum Retail Price Inclusive of all taxes including GST.

Arteor™ IoT

Cover Plates

Cat.Nos	Description	MRP* ₹ / Unit	Pack
---------	-------------	------------------	------

Wood Cover Plates with Overmoulded Frame

5758 83	Cover Plate + Support Frame - 4 Module - Grey Oak	3820	1/20
5758 84	Cover Plate + Support Frame - 6 Module - Grey Oak	5672	1/5
5758 85	Cover Plate + Support Frame - 8 Module - Grey Oak	6822	1/5
5758 86	Cover Plate + Support Frame - 2*4 Module - Grey Oak	8102	1/10
5758 87	Cover Plate + Support Frame - 2*6 Module - Grey Oak	10856	1/8



5758 72



5758 73

Signature Cover Plates with Overmoulded Frame

5758 71	Cover Plate + Support Frame - 1 Module - Cube Plate	8610	1/5/30
5758 72	Cover Plate + Support Frame - 2 Module - Cube Plate	8764	1/5/30
5758 73	Cover Plate + Support Frame - 3 Module - Cube Plate	10024	1/20
5758 74	Cover Plate + Support Frame - 4 Module - Cube Plate	10358	1/20
5758 75	Cover Plate + Support Frame - 6 Module - Cube Plate	13492	1/5
5758 76	Cover Plate + Support Frame - 8 Module - Cube Plate	14158	1/5
5758 77	Cover Plate + Support Frame - 2*4 Module - Cube Plate	21154	1/10
5758 78	Cover Plate + Support Frame - 2*6 Module - Cube Plate	23434	1/8

Cover Plates Without Frame

5757 10PL	Cover Plate without Frame for Wireless Switch-2 Module-White	218	5/50
5757 11PL	Cover Plate without Frame for Wireless Switch-2 Module-Pearl Aluminium	440	5/50



5757 10



5757 11

Bold Cat.Nos are products normally available with Legrand (India) Stockists. Cat.Nos that are not bold - delivery within 4 - 8 weeks from the date of order. Bold packing quantity is our mandatory packing. Orders to be placed by Legrand (India) Stockist in multiples of the same.

Arteor™ IoT

Cover Plates

Cat.Nos	Description	MRP* ₹ / Unit	Pack
---------	-------------	---------------------	------

Cover Plates Without Frame

5757 12PL	Cover Plate without Frame for Wireless Switch-2 Module-Graphite	348	5/50
5758 12PL	Cover Plate without Frame for Wireless Switch-2 Module-Magnesium	440	5/50
5758 23PL	Cover Plate without Frame for Wireless Switch-2 Module-Champagne	440	5/50
5758 34PL	Cover Plate without Frame for Wireless Switch-2 Module-Dark Bronze	440	5/50

Accessory

0648 71	Pack of 3*4 Extra Removable Stickers for Fixing A Wireless Control	806	1/25
---------	--	-----	------



5757 12

* MRP - Maximum Retail Price Inclusive of all taxes including GST.

Bold Cat.Nos are products normally available with Legrand (India) Stockists. Cat.Nos that are not bold - delivery within 4 - 8 weeks from the date of order. Bold packing quantity is our mandatory packing. Orders to be placed by Legrand (India) Stockist in multiples of the same.

Myrius™

A Perfect Blend of Design & Convenience



Myrius™ is designed to enhance modern living spaces by combining refined aesthetics with everyday usability. It brings together thoughtful design and intuitive functionality to create a seamless and comfortable user experience.

Features

- In-Mould decoration (IMD) technology enabling customised smart functions
- Integrated smart functionality for enhanced control and convenience
- Wide range of designer finishes to suit diverse interior styles
- Available in 11 premium plate finish options

Benefits

- Elevates interiors with distinctive designer aesthetics
- Enables personalised living through customised smart features
- Offers flexibility in design with a wide range of finishes
- Enhances everyday convenience with intuitive functionality

Scan to know more about the product.



Myrius: The best of both worlds

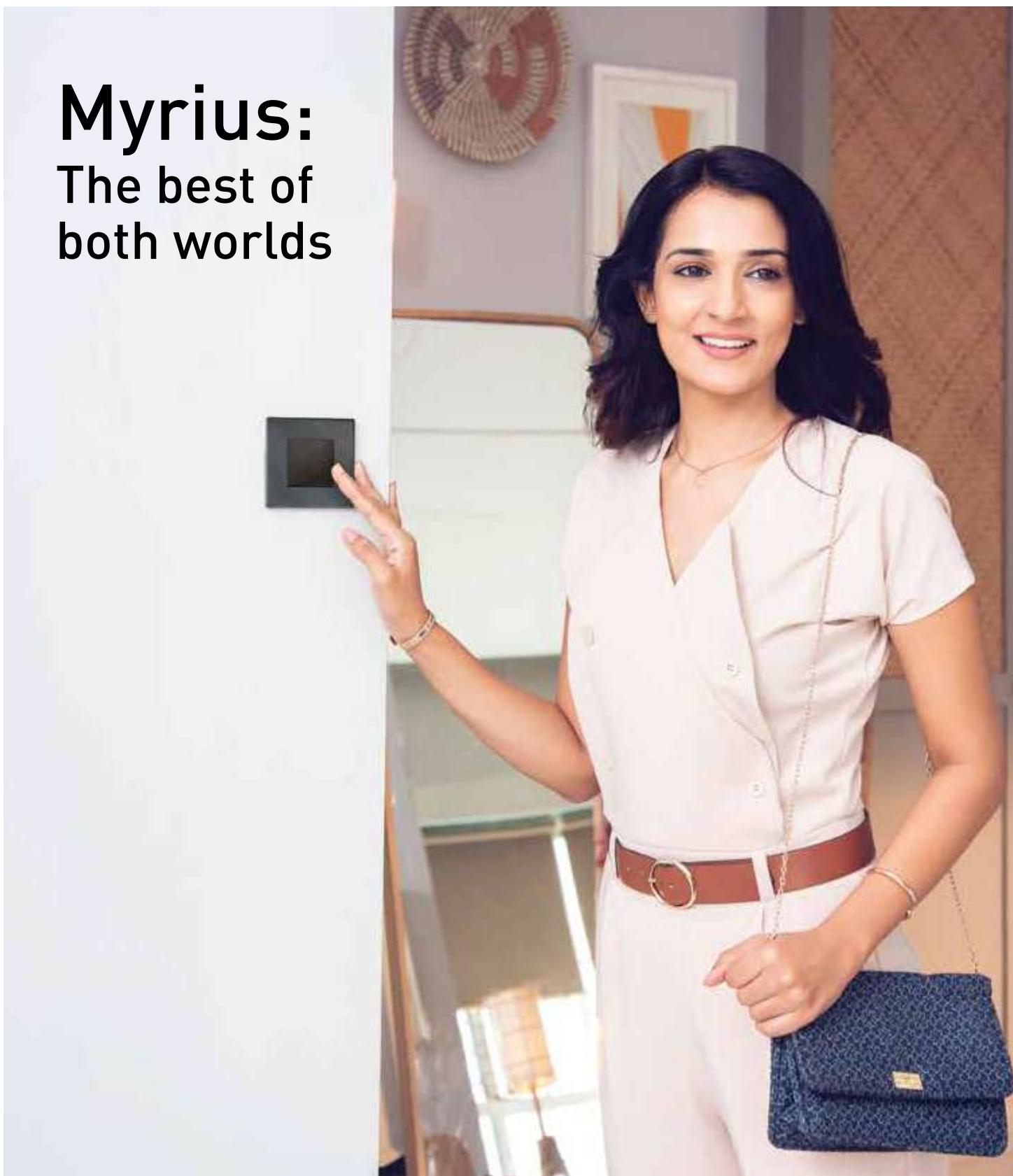

Myrius™

Premium Glass Finish for Modern Interiors



MYRIUS GLASS FINISH

Myrius™ Glass plate enhances interior spaces with sleek glass finishes and a refined flush design, bringing a modern and sophisticated aesthetic to premium environments.

Features

- 3 mm toughened glass finishes available in white and black
- Plate range from 1 to 18 modules for design flexibility
- Available in multiple colour options

Benefits

- Enhances interior aesthetics with elegant and modern glass finishes
- Adds a modern and sophisticated look to spaces
- Ensures design flexibility across different layouts



Myrius™

Designed for Hygiene.
Built for Everyday
Living.



ANTI-BACTERIAL RANGE

Myrius™ Anti-Bacterial Range is designed to support healthier living by reducing bacterial presence on frequently touched surfaces, combining hygiene with modern design for everyday spaces.

Features

- Silver ion-infused surfaces for antibacterial protection
- Smooth finish for easy cleaning and maintenance
- Certified antibacterial performance
- Contemporary design suitable for modern interiors

Benefits

- Reduces bacterial presence on frequently touched surfaces
- Supports a healthier home environment
- Enhances everyday safety through hygienic materials
- Combines hygiene with modern aesthetics



Myrius™

Cover Plates Cover Plates

Cat.Nos	Description	MRP* ₹ / Unit	Pack
---------	-------------	------------------	------

Switches 6A - 230V AC

6792 00	6A - Switch - 1 Way - 1 Module	160	1/20/200
6792 01	6A - Switch - 2 Way - 1 Module	292	1/20/200
6792 02	6A - Switch - 1 Way - with Indicator - 1 Module	270	1/20/200
6792 03	6A - Switch - 1 Way - with "Light" Marking - 1 Module	230	1/20/200
6792 04	6A - Switch - 1 Way - with "Fan" Marking - 1 Module	230	1/20/200

Switches - 10A - 230V AC

6793 00	10A - Switch - 1 Way - 1 Module	170	20/200
6793 01	10A - Switch - 2 Way - 2 Module	298	20/200
6793 02	10A - Switch - 1 Way - with Indicator - 1 Module	278	20/200
6792 05	10A - Switch - 1 Way - 2 Module	344	1/10/100
6792 06	10A - Switch - 2 Way - 2 Module	408	1/10/100
6792 07	10A - Intermediate Switch - 230V AC - 2 Module	2220	1/10/100
6792 08	10A - Switch - 1 Way - with Indicator - 2 Module	426	1/10/100

Switches - 16A - 230V AC

6792 09	16A - Switch - 1 Way - 1 Module	388	1/20/200
6792 10	16A - Switch - 2 Way - 1 Module	440	1/20/200
6792 11	16A - Switch - 1 Way - with Indicator - 1 Module	468	1/20/200

Switches - 20A - 230V AC

6792 12	20A - Switch - 1 Way - 1 Module	512	1/20/200
6792 13	20A - Switch - DP - 1 Way - 2 Module	784	1/10/100
6792 14	20A - Switch - DP - 1 Way - with Indicator - 2 Module	838	1/10/100
6792 15	20A - Switch - 2 Way - 2 Module	864	1/10/100

Switches - 25A - 230V AC

6792 16	25A - Switch - SP - 1 Way - with Indicator - 1 Module	576	1/20/200
---------	---	-----	----------

Switches - 32A - 230V AC

6792 17	32A - Switch - DP - with Indicator - 2 Module	1284	1/10/100
---------	---	------	----------

Myrius™

Classic White Mechanism

Cat.Nos	Description	MRP* ₹ / Unit	Pack
---------	-------------	------------------	------

Push Button - 6A - 230V AC

6792 18	6A - Push Button - SP - 1 Module	324	1/20/200
6792 19	6A - Push Button - SP - 1 Way - with Indicator - 1 Module	426	1/20/200
6792 20	6A - Bell Push - 1 Way - 1 Module	326	1/20/200
6792 21	6A - Bell Push - 1 Way - with Indicator - 1 Module	426	1/20/200
6792 22	6A - Bell Push - 1 Way - 2 Module	494	1/10/100
6792 23	6A - Bell Push - 1 Way - with Indicator - 2 Module	576	1/10/100

Accessories for Switches

6792 24	Lamp for Switches - 230V AC	80	1/5/50
---------	-----------------------------	----	--------

Indian Standard Socket

6792 35	6A - Socket - with Shutter - 3 Pin - ISI - 2 Module	278	1/20/200
6792 30	6/16A - Socket - with Shutter - ISI - 2 Module	592	1/10/100
6792 29	6/16A - Socket - with Shutter - ISI - 3 Module	708	1/5/50
6792 26	16A - Switch Socket - with Shutter - 3 Pin - 3 Module	1538	1/5/50

Dimmers & Fan Regulators

6792 36	Rotary Dimmer - 400 Watts - 1 Module	1504	5/50
6792 37	Rotary Light Dimmer - 500 Watts - 2 Module	2270	10/100
6792 39	Fan Regulator - 100 Watts - ISI - 1 Module	1168	5/50
6792 40	Fan Regulator - 100 Watts - 360° - ISI - 2 Module	1340	10/100
6792 41	Fan Regulator - 120 Watts - 360° - ISI - 2 Module	1446	10/100
6792 42	Fan Regulator - 70 Watts - ISI - 2 Module	1402	1/10/100
6792 31	Fan Regulator - 8 Step - 100 Watts ISI - 2 Module	1224	10/100
6792 96	Fan Regulator - BLDC - 2 Module [^]	1426	10/100

* MRP - Maximum Retail Price Inclusive of all taxes including GST.

[^] Compatible with Atomberg (Efficio), Havells (Eficiencia neo), Orient (Aerostorm) as per 2023 fan models.

Bold Cat.Nos are products normally available with Legrand (India) Stockists. Cat.Nos that are not bold - delivery within 4 - 8 weeks from the date of order. Bold packing quantity is our mandatory packing. Orders to be placed by Legrand (India) Stockist in multiples of the same.

Myrius™

Classic White Mechanism

Cat.Nos	Description	MRP ₹ / Unit	Pack
---------	-------------	--------------------	------

Emergency Light

6792 43	Emergency Removable LED Lamp - 2 Module	3742	1/10/100
---------	---	------	----------

Skirting Light

6792 48	Skirting Light - with Warm White LED - 3 Module	1132	1/5/25
---------	---	------	--------

Indicator

NEW! 6792 97	Indicator Unit - with Transparent LED - 1 Module	626	1/10/100
---------------------	--	-----	----------

Bell Call Indicator

6792 49	Bell Call Indicator - 1 Module	1492	1/20/200
---------	--------------------------------	------	----------

Buzzer

6792 50	Buzzer - 230V - 1 Module	1378	1/20/200
---------	--------------------------	------	----------

Infrared Sensors

6792 51	Infrared Sensor Switch - 400 Watts - 2 Module	2632	1/50
---------	---	------	------

Remote Unit

6792 52	Remote Control Unit - for Light & Fan - 4 Module	8988	1/5/20
6793 03	Remote Control Hand Unit	794	1/5/30

Hospitality Function

Hotel Keycard Switch

6792 53	16A - Key Card Switch - 2 Module	5390	1/10
6792 55	Key Fob for Key Card Switch	234	1/10/100

Hotel "DND and MMR" Functions

6792 56	External DND & MMR Control Unit - with Bell Push - 2 Module	2298	1/10/100
6792 57	Internal DND & MMR Control Unit - 2 Module	1534	1/10/100

Shaver Socket

6792 58	Shaver Socket - 110/230V AC - Monoblock with Plate - 2 Module	4012	1/16
6792 59	Shaver Socket - 110/230V AC - Monoblock with Plate - 4 Module	6552	1/5/20

Tv Sockets

6792 60	TV Co - axial Socket - 1 Module	302	1/20/200
---------	---------------------------------	-----	----------

Data & Voice

6792 62	Telephone Socket - RJ11 - 1 Module	298	1/20/200
6792 63	Telephone Socket - Double RJ11 - 1 Module	460	1/20/200
6792 64	Information Socket - RJ45 - Cat 5E - UTP - Toolless with Shutter - 1 Module	609	1/20/200
6792 65	Information Socket - RJ45 - Cat 6 - UTP - Toolless with Shutter - 1 Module	907	1/20/200
6792 66	Information Socket - RJ45 - Cat 6 - UTP - Toolless with Shutter - 2 Module	925	1/10/100
6797 13	Information Socket - RJ45 - Cat 6A - STP - 1 Module	1065	20/200

Myrius™

Classic White Mechanism

Cat.Nos	Description	MRP ₹ / Unit	Pack
---------	-------------	--------------------	------

Audio Video Connectors

6792 67	Preterminated Audio/Video Connector - 1 Module	2399	1/10
6792 68	Preterminated Projector Connector - 1 Module	2939	1/10
6792 69	Preterminated HDMI Socket - 1 Module	2939	1/10

Sound (Volume Controller)

6792 70	Volume Controller - 2 Module	1795	1/10/100
---------	------------------------------	------	----------

Protectors & Accessories

Motor Starter

6792 71	16A - Motor Starter - 2 Module	952	1/10/100
6792 72	25A - Motor Starter - 2 Module	972	1/10/100

Electronic Function

USB Chargers (IS13252(Part 1) / IEC 60950-1)

6792 88	USB Charger - 1500mA - Type A - 1 Module	2056	1/5/50
6792 89	USB Charger - 3000mA - Type A + C - 2 Module	3180	1/10/100
6797 51	USB Charger - 3000mA/15 Watts - Type A - 1 Module	2376	1/5/50
6797 52	USB Charger - 3000mA/15 Watts - Type A + A - 1 Module	2676	1/5/50
6797 53	USB Charger - 3000mA/15 Watts - Type A + C - 1 Module	3408	1/5/50
6797 54	USB Charger - 3000mA/15 Watts - Type C + C - 1 Module	3722	1/5/50
6797 55	USB Charger - Power Delivery - 20 Watts - Type C - 1 Module	4534	1/5/50
6792 73	USB Charger - Power Delivery - 30 Watts - Type C + C - 2 Module	6878	1/3/30
6797 57	USB Charger - Power Delivery - 45 Watts - Type C - 2 Module	8966	1/3/30
NEW! 6797 59	USB Charger - Power Delivery - 65 Watts - Type C + C - 3 Module	11058	1/5/20

Loud Speakers

6792 98	Ceiling Loudspeaker - 8Ohms - 100mm	3759	1/6
---------	-------------------------------------	------	-----

Sound Diffusion

6792 99	Bluetooth Sound Diffusion - 2 Module	7697	1/10/100
---------	--------------------------------------	------	----------

Rotary Dimmer Universal

6793 04	Rotary LED Light Dimmer - 50 Watts - 1 Module	3110	1/10/120
---------	---	------	----------

* MRP - Maximum Retail Price Inclusive of all taxes including GST.
Red Cat. Nos - New Products

Bold Cat.Nos are products normally available with Legrand (India) Stockists. Cat.Nos that are not bold - delivery within 4 - 8 weeks from the date of order. Bold packing quantity is our mandatory packing. Orders to be placed by Legrand (India) Stockist in multiples of the same.

Myrius™

Classic White Mechanism

Cat.Nos	Description	MRP ₹ / Unit	Pack
---------	-------------	--------------------	------

Touch Switches

6793 08	Touch Switch - 2 Switch - 1 Way - 1000 Watts - 2 Module - Silver	4350	1/50
6793 09	Touch Switch - 1 Way - 1440 Watts - 2 Module - Silver	4350	1/50
6793 10	Touch Switch - 2 Way - 1000 Watts - 2 Module - Silver	5030	1/50
6793 13	Touch Switch - 1 Way - 3000 Watts - 2 Module - Silver	5030	1/50
6793 06	Touch Switch - Bell Push - 1440 Watts - 2 Module - Silver	4350	1/50

Touch Regulator, Curtain & Dimmer

6793 07	Touch Switch - Curtain Controller - 2 Module - Silver	5030	1/50
6793 05	Touch Fan Regulator - 100 Watts - 2 Module - Silver	5030	1/50
6793 15	Universal LED Touch Scroll Dimmer - 300 Watts - 2 Module - Silver	4976	1/50

Reading Light

6793 16	Reading Light LED - 2 Module	3110	1/10
---------	------------------------------	------	------

Accessories

6792 75	Cable Outlet - 8mm - 1 Module	336	1/20/200
6792 76	Blanking Plate - 1 Module	62	1/40/400
6792 77	Blanking Plate - 2 Module	72	1/10/100

Charcoal Grey- Mechanism

Switches - 6A - 230V AC

6794 00	6A - Switch - 1 Way - 1 Module	198	1/20/200
6794 01	6A - Switch - 2 Way - 1 Module	324	1/20/200
6794 02	6A - Switch - 1 Way - with Indicator - 1 Module	352	1/20/200
6794 03	6A - Switch - 1 Way - with "Light" Marking - 1 Module	274	1/20/200
6794 04	6A - Switch - 1 Way - with "Fan" Marking - 1 Module	274	1/20/200

Switches - 10A - 230V AC

6794 05	10A - Switch - 1 Way - 2 Module	412	1/10/100
6794 06	10A - Switch - 2 Way - 2 Module	440	1/10/100
6794 07	10A - Intermediate Switch - 230V AC - 2 Module	2558	1/10/100
6794 08	10A - Switch - 1 Way - with Indicator - 2 Module	474	1/10/100

Myrius™

Charcoal Grey Mechanism

Cat.Nos	Description	MRP ₹ / Unit	Pack
---------	-------------	--------------------	------

Switches - 16A - 230V AC

6794 09	16A - Switch - 1 Way - 1 Module	432	1/20/200
6794 10	16A - Switch - 2 Way - 1 Module	526	1/20/200
6794 11	16A - Switch - 1 Way - with Indicator - 1 Module	544	1/20/200

Switches - 20A - 230V AC

6794 12	20A - Switch - 1 Way - 1 Module	582	1/20/200
6794 13	20A - Switch - DP - 1 Way - 2 Module	908	1/10/100
6794 14	20A - Switch - DP - 1 Way - with Indicator - 2 Module	964	1/10/100
6794 15	20A - Switch - 2 Way - 2 Module	992	1/10/100

Switches - 25A - 230V AC

6794 16	25A - Switch - SP - 1 Way - with Indicator - 1 Module	664	1/20/200
---------	---	-----	----------

Switches 32A 230V AC

6794 17	32A - Switch - DP - with Indicator - 2 Module	1480	1/10/100
---------	---	------	----------

Push Button 6A 230V AC

6794 18	6A - Push Button - SP - 1 Way - 1 Module	386	1/20/200
6794 19	6A - Push Button - 1 Way - with Indicator - 1 Module	482	1/20/200
6794 20	6A - Bell Push - 1 Way - 1 Module	360	1/20/200
6794 21	6A - Bell Push - 1 Way - with Indicator - 1 Module	482	1/20/200
6794 22	6A - Bell Push - 1 Way - 2 Module	556	1/10/100
6794 23	6A - Bell Push - 1 Way - with Indicator - 2 Module	664	1/10/100

Indian Standard Socket

6794 35	6A - Socket - with Shutter - 3 Pin - ISI - 2 Module	318	1/20/200
6794 30	6/16A - Socket - with Shutter - ISI - 2 Module	696	1/10/100
6794 29	6/16A - Socket - with Shutter - ISI - 3 Module	822	1/5/50
6794 26	16A - Switched Socket - with Shutter - 3 Pin - 3 Module	1752	1/5/50

* MRP - Maximum Retail Price Inclusive of all taxes including GST.

Bold Cat.Nos are products normally available with Legrand (India) Stockists. Cat.Nos that are not bold - delivery within 4 - 8 weeks from the date of order. Bold packing quantity is our mandatory packing. Orders to be placed by Legrand (India) Stockist in multiples of the same.

Myrius™ Charcoal Grey Mechanism

Cat.Nos	Description	MRP ₹ / Unit	Pack
---------	-------------	--------------------	------

Dimmers & Fan Regulators

6794 36	Rotary Dimmer - 400 Watts - 1 Module	1720	5/50
6794 37	Rotary Light Dimmer - 500 Watts - 2 Module	2612	10/100
6794 39	Fan Regulator - 100 Watts - ISI - 1 Module	1344	5/50
6794 40	Fan Regulator - 100 Watts - 360° - ISI - 2 Module	1522	10/100
6794 41	Fan Regulator - 120 Watts - 360° - ISI - 2 Module	1678	10/100
6794 42	Fan Regulator - 70 Watts - ISI - 2 Module	1620	1/10/100
6794 31	Fan Regulator - 8 Steps - 100 Watts - ISI - 2 Module	1392	10/100
6794 96	Fan Regulator - BLDC - 2 Module ^A	1646	10/100

Skirting Light

6794 48	Skirting Light - with Warm White LED - 3 Module	1296	1/5/25
---------	---	------	--------

Bell Call Indicator

6794 49	Bell Call Indicator - 1 Module	1736	1/20/200
---------	--------------------------------	------	----------

Buzzer

6794 50	Buzzer - 230V - 1 Module	1582	1/20/200
---------	--------------------------	------	----------

Remote Unit

6794 52	Remote Control Unit - for Light & Fan - 4 Module	10332	1/5/20
6793 03	Remote Control Hand Unit	794	1/5/30

Hospitality Function Hotel Keycard Switch

6794 53	16A - Key Card Switch - 2 Module	6200	1/10
6792 55	Key Fob for Key Card Switch	234	1/10/100

Hotel "DND and MMR" Functions

6794 54	External DND & MMR Control Unit - with Bell Push - 2 Module	2636	1/10/100
6794 55	Internal DND & MMR Control Unit - 2 Module	1738	1/10/100

Shaver Socket

6794 58	Shaver Socket - 120/240V AC - Monoblock with Plate - 2 Module	4568	1/16
6794 59	Shaver Socket - 120/230V AC - Monoblock with Plate - 4 Module	7248	1/5/20

Sockets & Connectors

Tv Sockets

6794 60	TV Co - axial Socket - 1 Module	362	1/20/200
---------	---------------------------------	-----	----------

Myrius™ Charcoal Grey Mechanism

Cat.Nos	Description	MRP ₹ / Unit	Pack
---------	-------------	--------------------	------

Data & Voice

6794 62	Telephone Socket - RJ11 - 1 Module	348	1/20/200
6794 63	Telephone Socket - Double RJ11 - 1 Module	534	1/20/200
6794 64	Information Socket - RJ45 - Cat 5E - UTP - Toolless with Shutter - 1 Module	706	1/20/200
6794 65	Information Socket - RJ45 - Cat 6 - UTP - Toolless with Shutter - 1 Module	1042	1/20/200
6794 66	Information Socket - RJ45 - Cat 6 - UTP - Toolless with Shutter - 2 Module	1069	1/10/100
6797 14	Information Socket - RJ45 - Cat 6A - STP - 1 Module	1214	20/200

Audio & Video Connectors

6794 67	Preterminated Audio/Video Connector - 1 Module	2756	1/10
6794 68	Preterminated HDMI Socket - 1 Module	3376	1/10
6794 69	Preterminated Projector Connector - 1 Module	3376	1/10

Sound (Volume Controller)

6794 70	Volume Controller - 2 Module	2083	1/10/100
---------	------------------------------	------	----------

Protectors & Accessories Motor Starter

6794 71	16A - Motor Starter - 2 Module	1098	1/10/100
6794 72	25A - Motor Starter - 2 Module	1122	1/10/100

Electronic Function

USB Chargers (IS13252 (Part 1) / IEC 60950-1)

6794 88	USB Charger - 1500mA - Type A - 1 Module	2358	1/5/100
6794 89	USB Charger - 3000mA - Type A + C - 2 Module	3654	1/10/100
6798 51	USB Charger - 3000mA/15 Watts - Type A - 1 Module	2720	1/5/50
6798 52	USB Charger - 3000mA/15 Watts - Type A + A - 1 Module	3002	1/5/50
6798 53	USB Charger - 3000mA/15 Watts - Type A + C - 1 Module	3826	1/5/50
6798 54	USB Charger - 3000mA/15 Watts - Type C + C - 1 Module	4054	1/5/50
6798 55	USB Charger - Power Delivery - 20 Watts - Type C - 1 Module	5002	1/5/50
6792 74	USB Charger - Power Delivery - 30 Watts - Type C + C - 2 Module	7272	1/3/30
6798 57	USB Charger - Power Delivery - 45 Watts - Type C - 2 Module	9442	1/3/30
6798 59	USB Charger - Power Delivery - 65 Watts - Type C + C - 3 Module	11614	1/5/20

* MRP - Maximum Retail Price Inclusive of all taxes including GST.

^A Compatible with Atomberg (Efficio), Havells (Efficiencia neo), Orient (Aerostorm) as per 2023 fan models.

Red Cat. Nos - New Products

Bold Cat.Nos are products normally available with Legrand (India) Stockists. Cat.Nos that are not bold - delivery within 4 - 8 weeks from the date of order. Bold packing quantity is our mandatory packing. Orders to be placed by Legrand (India) Stockist in multiples of the same.

Myrius™

Classic White Anti Bacterial Mechanism

Cat.Nos	Description	MRP ₹ / Unit	Pack
---------	-------------	--------------------	------

Sound Receiver

6794 97	Bluetooth Sound Diffusion - 2 Module	8854	1/10/100
---------	--------------------------------------	------	----------

Rotary Dimmer Universal

6794 98	Rotary LED Light Dimmer - 50 Watts - 1 Module	3544	1/10/120
---------	---	------	----------

Accessories

6794 75	Cable Outlet - 8mm - 1 Module	392	1/20/200
6794 76	Blanking Plate - 1 Module	68	1/40/400

Classic White - Anti Bacterial Mechanism Switches - 6A - 230V AC

6793 20	6A - Switch - 1 Way - 1 Module - Anti - Bacterial	232	1/20/200
6793 21	6A - Switch - 2 Way - 1 Module - Anti - Bacterial	342	1/20/200
6793 24	6A - Bell Push - 1 Module - Anti - Bacterial	398	1/20/200

Switches - 16A - 230V AC

6793 22	16A - Switch - 1 Way - 1 Module - Anti - Bacterial	468	1/20/200
6793 23	16A - Switch - 2 Way - 1 Module - Anti - Bacterial	544	1/20/200

Indian Standard Socket

6792 38	6A - Socket - with Shutter - 3 Pin - ISI - 2 Module - Anti - Bacterial	348	1/20/200
6793 28	6/16A - Socket - with Shutter - ISI - 2 Module - Anti - Bacterial	812	1/10/100
6793 29	6/16A - Socket - with Shutter - ISI - 3 Module - Anti - Bacterial	874	1/5/50

Fan Regulators

6793 25	Fan Regulator - 120 Watts - 360° - ISI - 2 Module - Anti - Bacterial	1776	10/100
---------	--	------	--------

TV Sockets

6793 30	TV Co - axial Socket - 1 Module - Anti - Bacterial	362	1/20/200
---------	--	-----	----------

Data & Voice

6793 31	Telephone Socket - RJ11 - 1 Module - Anti - Bacterial	362	1/20/200
6793 32	Information Socket - RJ45 - Cat 6 - UTP - 1 Module - Anti - Bacterial	1104	1/20/200

Accessories

6793 33	Blanking Plate - 1 Module - Anti - Bacterial	62	1/40/400
---------	--	----	----------

Myrius™

Cover Plates

Cat.Nos	Description	MRP ₹ / Unit	Pack
---------	-------------	--------------------	------

Cover Plates with Support Frame

Classic White Cover Plates with Support Frame

6795 01	Cover Plate - 1 Module - Classic White	248	20/200
6795 02	Cover Plate - 2 Module - Classic White	258	20/200
6795 03	Cover Plate - 3 Module - Classic White	272	10/100
6795 04	Cover Plate - 4 Module - Classic White	304	10/100
6795 06	Cover Plate - 6 Module - Classic White	526	5/50
6795 08	Cover Plate - 8 Module - Classic White	576	5/50
6795 09	Cover Plate - 2*4 Module - Classic White	732	5/25
6795 10	Cover Plate - 9 Module - Classic White	774	5/50
6795 12	Cover Plate - 12 Module - Classic White	878	1/10
6795 16	Cover Plate - 16 Module - Classic White	1022	1/10
6795 17	Cover Plate - 16 Module(Big) - Classic White	1108	1/10
6795 18	Cover Plate - 18 Module - Classic White	1172	1/10

Charcoal Grey Cover Plates with Support Frame

6797 01	Cover Plate - 1 Module - Charcoal Grey	300	20/200
6797 02	Cover Plate - 2 Module - Charcoal Grey	314	20/200
6797 03	Cover Plate - 3 Module - Charcoal Grey	340	10/100
6797 04	Cover Plate - 4 Module - Charcoal Grey	364	10/100
6797 06	Cover Plate - 6 Module - Charcoal Grey	650	5/50
6797 08	Cover Plate - 8 Module - Charcoal Grey	708	5/50
6797 09	Cover Plate - 2*4 Module - Charcoal Grey	900	5/25
6797 10	Cover Plate - 9 Module - Charcoal Grey	966	5/50
6797 12	Cover Plate - 12 Module - Charcoal Grey	1082	1/10
6797 16	Cover Plate - 16 Module - Charcoal Grey	1252	1/10
6797 17	Cover Plate - 16 Module(Big) - Charcoal Grey	1348	1/10
6797 18	Cover Plate - 18 Module - Charcoal Grey	1440	1/10

Ice White Cover Plates with Support Frame

6795 21	Cover Plate - 1 Module - Ice White	352	1/5/30
6795 22	Cover Plate - 2 Module - Ice White	372	1/5/30
6795 23	Cover Plate - 3 Module - Ice White	396	1/20
6795 24	Cover Plate - 4 Module - Ice White	422	1/20
6795 26	Cover Plate - 6 Module - Ice White	766	1/10
6795 28	Cover Plate - 8 Module - Ice White	834	1/10
6795 29	Cover Plate - 2*4 Module - Ice White	1044	1/5

* MRP - Maximum Retail Price Inclusive of all taxes including GST.

Bold Cat.Nos are products normally available with Legrand (India) Stockists. Cat.Nos that are not bold - delivery within 4 - 8 weeks from the date of order. Bold packing quantity is our mandatory packing. Orders to be placed by Legrand (India) Stockist in multiples of the same.

Myrius™

Cover Plates

Cat.Nos	Description	MRP ₹ / Unit	Pack
6795 32	Cover Plate - 12 Module - Ice White	1270	1/5
6795 36	Cover Plate - 16 Module - Ice White	1478	1/5
6795 37	Cover Plate - 16 Module(Big) - Ice White	1566	1/5
6795 38	Cover Plate - 18 Module - Ice White	1694	1/5

Ice Black Cover Plates with Support Frame

6795 41	Cover Plate - 1 Module - Ice Black	352	1/5/30
6795 42	Cover Plate - 2 Module - Ice Black	372	1/5/30
6795 43	Cover Plate - 3 Module - Ice Black	396	1/20
6795 44	Cover Plate - 4 Module - Ice Black	422	1/20
6795 46	Cover Plate - 6 Module - Ice Black	766	1/10
6795 48	Cover Plate - 8 Module - Ice Black	834	1/10
6795 49	Cover Plate - 2*4 Module - Ice Black	1044	1/5
6795 52	Cover Plate - 12 Module - Ice Black	1270	1/5
6795 56	Cover Plate - 16 Module - Ice Black	1478	1/5
6795 57	Cover Plate - 16 Module(Big) - Ice Black	1566	1/5
6795 58	Cover Plate - 18 Module - Ice Black	1694	1/5

Pearl Champagne Cover Plates with Support Frame

6795 61	Cover Plate - 1 Module - Pearl Champagne	480	1/5/30
6795 62	Cover Plate - 2 Module - Pearl Champagne	508	1/5/30
6795 63	Cover Plate - 3 Module - Pearl Champagne	540	1/20
6795 64	Cover Plate - 4 Module - Pearl Champagne	584	1/20
6795 66	Cover Plate - 6 Module - Pearl Champagne	1044	1/10
6795 68	Cover Plate - 8 Module - Horizontal - Pearl Champagne	1140	1/10
6795 69	Cover Plate - 2*4 Module - Vertical - Pearl Champagne	1428	1/5
6795 72	Cover Plate - 12 Module - Pearl Champagne	1728	1/5
6795 76	Cover Plate - 16 Module - Pearl Champagne	2010	1/5
6795 77	Cover Plate - 16 Module(Big) - Pearl Champagne	2134	1/5
6795 78	Cover Plate - 18 Module - Pearl Champagne	2314	1/5

Sonic Silver Cover Plates with Support Frame

6795 81	Cover Plate - 1 Module - Sonic Silver	480	1/5/30
6795 82	Cover Plate - 2 Module - Sonic Silver	508	1/5/30

Myrius™

Cover Plates

Cat.Nos	Description	MRP ₹ / Unit	Pack
6795 83	Cover Plate - 3 Module - Sonic Silver	540	1/20
6795 84	Cover Plate - 4 Module - Sonic Silver	584	1/20
6795 86	Cover Plate - 6 Module - Sonic Silver	1044	1/10
6795 88	Cover Plate - 8 Module - Horizontal - Sonic Silver	1140	1/10
6795 89	Cover Plate - 2*4 Module - Vertical - Sonic Silver	1428	1/5
6795 92	Cover Plate - 12 Module - Sonic Silver	1728	1/5
6795 96	Cover Plate - 16 Module - Sonic Silver	2010	1/5
6795 97	Cover Plate - 16 Module(Big) - Sonic Silver	2134	1/5
679598	Cover Plate - 18 Module - Sonic Silver	2314	1/5

Dark Fade Cover Plates with Support Frame

6796 01	Cover Plate - 1 Module - Dark Fade	480	1/5/30
6796 02	Cover Plate - 2 Module - Dark Fade	508	1/5/30
6796 03	Cover Plate - 3 Module - Dark Fade	540	1/20
6796 04	Cover Plate - 4 Module - Dark Fade	584	1/20
6796 06	Cover Plate - 6 Module - Dark Fade	1044	1/10
6796 08	Cover Plate - 8 Module - Horizontal - Dark Fade	1140	1/10
6796 09	Cover Plate - 2*4 Module - Vertical - Dark Fade	1428	1/5
6796 12	Cover Plate - 12 Module - Dark Fade	1728	1/5
6796 16	Cover Plate - 16 Module - Dark Fade	2010	1/5
6796 17	Cover Plate - 16 Module(Big) - Dark Fade	2134	1/5
6796 18	Cover Plate - 18 Module - Dark Fade	2314	1/5

Ice Graphite Cover Plates with Support Frame

6797 21	Cover Plate - 1 Module - Ice Graphite	352	1/5/30
6797 22	Cover Plate - 2 Module - Ice Graphite	372	1/5/30
6797 23	Cover Plate - 3 Module - Ice Graphite	396	1/20
6797 24	Cover Plate - 4 Module - Ice Graphite	422	1/20
6797 26	Cover Plate - 6 Module - Ice Graphite	766	1/10
6797 28	Cover Plate - 8 Module - Horizontal - Ice Graphite	834	1/10
6797 29	Cover Plate - 2*4 Module - Vertical - Ice Graphite	1046	1/5
6797 32	Cover Plate - 12 Module - Ice Graphite	1264	1/5
6797 36	Cover Plate - 16 Module - Ice Graphite	1476	1/5
6797 37	Cover Plate - 16 Module(Big) - Ice Graphite	1566	1/5
6797 38	Cover Plate - 18 Module - Ice Graphite	1694	1/5

* MRP - Maximum Retail Price Inclusive of all taxes including GST.

Bold Cat.Nos are products normally available with Legrand (India) Stockists. Cat.Nos that are not bold - delivery within 4 - 8 weeks from the date of order. Bold packing quantity is our mandatory packing. Orders to be placed by Legrand (India) Stockist in multiples of the same.

Myrius™ Cover Plates

Cat.Nos	Description	MRP ₹ / Unit	Pack
---------	-------------	--------------------	------

Ice Silk Cover Plates with Support Frame

6797 41	Cover Plate - 1 Module - Ice Silk	352	1/5/30
6797 42	Cover Plate - 2 Module - Ice Silk	372	1/5/30
6797 43	Cover Plate - 3 Module - Ice Silk	396	1/20
6797 44	Cover Plate - 4 Module - Ice Silk	422	1/20
6797 46	Cover Plate - 6 Module - Ice Silk	766	1/10
6797 48	Cover Plate - 8 Module - Horizontal - Ice Silk	834	1/10
6797 49	Cover Plate - 2*4 Module - Vertical - Ice Silk	1046	1/5
6797 62	Cover Plate - 12 Module - Ice Silk	1264	1/5
6797 56	Cover Plate - 16 Module - Ice Silk	1476	1/5
6797 67	Cover Plate Big - 16 Module(Big) - Ice Silk	1566	1/5
6797 68	Cover Plate - 18 Module - Ice Silk	1694	1/5

White Glass Cover Plates with Support Frame

6798 11	Cover Plate - 1 Module - White Glass	1274	1/5/30
6798 12	Cover Plate - 2 Module - White Glass	1296	1/5/30
6798 13	Cover Plate - 3 Module - White Glass	1370	1/20
6798 14	Cover Plate - 4 Module - White Glass	1542	1/20
6798 16	Cover Plate - 6 Module - White Glass	1686	1/10
6798 18	Cover Plate - 8 Module - Horizontal - White Glass	1826	1/10
6798 19	Cover Plate - 2*4 Module - Vertical - White Glass	2232	1/5
6798 22	Cover Plate - 12 Module - White Glass	2842	1/5
6798 26	Cover Plate - 16 Module - White Glass	5022	1/5
6798 28	Cover Plate - 18 Module - White Glass	6226	1/5

Black Glass Cover Plates with Support Frame

6798 31	Cover Plate - 1 Module - Black Glass	1274	1/5/30
6798 32	Cover Plate - 2 Module - Black Glass	1296	1/5/30
6798 33	Cover Plate - 3 Module - Black Glass	1370	1/20
6798 34	Cover Plate - 4 Module - Black Glass	1542	1/20
6798 36	Cover Plate - 6 Module - Black Glass	1686	1/10
6798 38	Cover Plate - 8 Module - Horizontal - Black Glass	1826	1/10

Myrius™ Cover Plates

Cat.Nos	Description	MRP ₹ / Unit	Pack
---------	-------------	--------------------	------

Black Glass Cover Plates with Support Frame

6798 39	Cover Plate - 2*4 Module - Vertical - Black Glass	2232	1/5
6798 42	Cover Plate - 12 Module - Black Glass	2842	1/5
6798 46	Cover Plate - 16 Module - Black Glass	5022	1/5
6798 48	Cover Plate - 18 Module - Black Glass	6226	1/5

Anti-Bacterial Cover Plates with Support Frame

6793 41	Cover Plate - 1 Module - Anti-Bacterial-Classic White	278	20/200
6793 42	Cover Plate - 2 Module - Anti-Bacterial-Classic White	306	20/200
6793 43	Cover Plate - 3 Module - Anti-Bacterial-Classic White	344	10/100
6793 44	Cover Plate - 4 Module - Anti-Bacterial-Classic White	366	10/100
6793 46	Cover Plate - 6 Module - Anti-Bacterial-Classic White	600	5/50
6793 48	Cover Plate - 8 Module - Horizontal - Anti-Bacterial-Classic White	704	5/50
6793 49	Cover Plate - 2*4 Module - Vertical - Anti-Bacterial-Classic White	880	5/25
6793 50	Cover Plate - 9 Module - Anti-Bacterial-Classic White	912	5/50
6793 52	Cover Plate - 12 Module - Anti-Bacterial-Classic White	1010	10
6793 56	Cover Plate - 16 Module - Anti-Bacterial-Classic White	1196	10
6793 58	Cover Plate - 18 Module - Anti-Bacterial-Classic White	1334	10

Metal Flush Boxes

6890 07	Metal Flush Box - 1/2 Module	170	40
6890 08	Metal Flush Box - 3 Module	170	40
6890 09	Metal Flush Box - 4 Module	226	40
6890 10	Metal Flush Box - 6 Module	358	40
6890 42	Metal Flush Box - 8 Module	416	40
6890 31	Metal Flush Box - 2*4 Module	414	20
6890 29	Metal Flush Box - 9 Module	490	20
6890 11	Metal Flush Box - 12/16 Module	624	10
6890 12	Metal Flush Box - 18/24 Module	788	10

* MRP - Maximum Retail Price Inclusive of all taxes including GST.

Bold Cat.Nos are products normally available with Legrand (India) Stockists. Cat.Nos that are not bold - delivery within 4 - 8 weeks from the date of order. Bold packing quantity is our mandatory packing. Orders to be placed by Legrand (India) Stockist in multiples of the same.

Myrius™ Mounting Boxes

Cat.Nos	Description	MRP ₹ / Unit	Pack
---------	-------------	--------------------	------

Plastic Surface Boxes

6733 02	Plastic Surface Box - 1/2 Module	100	10/50
6733 03	Plastic Surface Box - 3 Module	114	5/35
6733 04	Plastic Surface Box - 4 Module	134	5/25
6733 06	Plastic Surface Box - 6 Module	172	1/10
6733 08	Plastic Surface Box - 8 Module	254	1/5
6733 05	Plastic Surface Box - 2*4 Module	240	1/5

Metal Surface Boxes

6890 21	Metal Surface Box - 12 Module (2 Rows*6)	600	1/6
6890 22	Metal Surface Box - 18 Module (3 Rows*6)	634	1/4

Myrius™

Guarantee

- The Company, at its discretion, will replace products if they have any manufacturing defect within 10 years for switches (without LED lamp) and power sockets. For all other **Myrius™** wiring accessories the guarantee will be 2 years.
- The above guarantee is applicable when the devices are used in Legrand metal flush boxes. Otherwise the guarantee period will be reduced by 50%.
- The guarantee is only applicable when the products are installed as per the Company's instructions and not tampered in any manner.
- The guarantee states the Company's entire liability. It does not extend to cover consequential loss or damage or installation costs arising from defective products.

Our switches are compliant with revised BIS standard (IS 3854:2023) requirements. Also, our switches are covered additionally for use on Self-Ballasted Lamp (SBL) loads.

SBL power rating as per IS3854:2023

Switch Rating	6A, 230V~	10A, 230V~	16A, 230V~	20A, 230V~
SBL power (Watt)	100 W	100 W	200 W	250 W

* MRP - Maximum Retail Price Inclusive of all taxes including GST.

Bold Cat.Nos are products normally available with Legrand (India) Stockists. Cat.Nos that are not bold - delivery within 4 - 8 weeks from the date of order. Bold packing quantity is our mandatory packing. Orders to be placed by Legrand (India) Stockist in multiples of the same.

Myrius™ IoT

Smart Control for Connected Living



Myrius™ IoT introduces wireless automation for lighting, curtains, and power outlets, enabling convenient smart control through the **Home+Control** smartphone app. Designed for modern homes, it allows users to create scenes, monitor energy usage, and manage devices remotely.

Features

- Control up to four scenarios with our wireless 4-scenario control switch
- Switch dimmer with neutral (1M) for smooth lighting adjustment
- Wireless switches and in-wall wireless switch options
- App and voice compatibility for convenient device management

Benefits

- Simplifies everyday living with personalized automation scenes
- Enables convenient hands-free operation through voice commands
- Provides visibility of energy consumption for better management
- Upgrades homes with smart capabilities without additional wiring

Scan to know more about
the product.



Product Range



WIRELESS 4 SCENARIO CONTROL – 2M



Switch DIMMER WITH NEUTRAL – 1M



WIRELESS Switch 2G – 2M



IN WALL WIRELESS Switch – 1M



IN WALL MASTER HOME IN/AWAY – 1M



IN WALL MASTER WAKE UP/SLEEP – 1M



IN WALL WIRELESS SHUTTER Switch – 1M



16A Smart mobile plug



Home + Control App

Control with:

TOUCH | SWIPE | TALK

Myrius™ IoT Connected Homes White Mechanism

Cat.Nos	Description	MRP* ₹ / Unit	Pack
---------	-------------	------------------	------

Connected Light Switches

6793 59	Connected Switch - with Neutral - Wired - 1 Module	11084	1/5/50
6793 60	Connected Switch - without Neutral - with Dimmer Option - Wired - 2 Module	14446	1/5/50
6793 70	Connected Switch Dimmer - with Neutral - 150 Watts - 1 Module	8860	1/5/50
6793 71	Connected Switch Dimmer - with Neutral - Wired - 2 Module	14332	1/5/20

Connected Outlets

6793 67	16A - Connected Socket Module - 1 Module	11380	1/5/50
---------	--	-------	--------

Connected Curtain/Roller Blind Switches

6793 61	Connected Curtain/Roller Blind Switch - Wired - 1 Module	11706	1/5/50
---------	--	-------	--------

Connected Step Fan Controller

6793 68	Connected Step Fan Controller - with Neutral -100W - 2 Module	8516	1/5/50
---------	---	------	--------

Connected Gateway Pack

6793 66	Connected Gateway + Master Home/Away Wireless Switch - Wired - 2 Module	23674	1/5/20
---------	---	-------	--------

Wireless Control Switch

6793 62	1 Gang - Wireless Switch - 2 Module	5212	1/5/30
6793 73	2 Gang - Wireless Switch - 2 Module	5250	1/5/30
6793 64	Curtain/Roller Blind Wireless Switch - 2 Module	5878	1/5/30

Wireless Scenario Control Switch

6793 63	Home/Away Wireless Master Switch - 2 Module	5600	1/5/30
6793 65	Wake Up/Sleep Wireless Scenario Control Switch - 2 Module	6110	1/5/30
6793 69	Wireless 4 Scenario Control Switch - 2 Module	6658	1/5/30

In Wall Wireless Switch

6793 72	In Wall Wireless Switch - 1 Module	4560	1/5/20
6793 94	In Wall Wireless Shutter Switch - 1 Module	5256	1/5/20
6793 92	In Wall Home/Away Wireless Switch - 1 Module	5336	1/5/20
6793 96	In Wall Wake Up/Sleep Wireless Switch - 1 Module	5336	1/5/20

* MRP - Maximum Retail Price Inclusive of all taxes including GST.

Myrius™ IoT Connected Homes Charcoal Grey Mechanism

Cat.Nos	Description	MRP* ₹ / Unit	Pack
---------	-------------	------------------	------

Connected Light Switches

6793 74	Connected Switch - with Neutral - Wired - 1 Module	12750	1/5/50
6793 75	Connected Switch - without Neutral - with Dimmer Option - Wired - 2 Module	16616	1/5/50
6793 85	Connected Switch Dimmer - with Neutral - 150 Watts - 1 Module	10186	1/5/20
6793 86	Connected Switch Dimmer - with Neutral - Wired - 2 Module	16476	1/5/20

Connected Outlets

6793 82	16A - Connected Socket Module - 1 Module	13088	1/5/50
---------	--	-------	--------

Connected Curtain/Roller Blind Switches

6793 76	Connected Curtain/Roller Blind Switch - Wired - 1 Module	13462	1/5/50
---------	--	-------	--------

Connected Step Fan Controller

6793 83	Connected Step Fan Controller - with Neutral -100W - 2 Module	9794	1/5/50
---------	---	------	--------

Connected Gateway Pack

6793 81	Connected Gateway + Home/Away Wireless Switch - Wired - 2 Module	27220	1/5/20
---------	--	-------	--------

Wireless Control Switch

6793 77	1 Gang - Wireless Switch - 2 Module	5996	1/5/30
6793 79	2 Gang - Wireless Switch - 2 Module	6346	1/5/30
6793 88	Curtain/Roller Blind Wireless Switch - 2 Module	6032	1/5/30

Wireless Scenario Control Switch

6793 78	Home/Away Wireless Master Switch - 2 Module	6860	1/5/30
6793 80	Wake Up/Sleep Wireless Scenario Control Switch - 2 Module	7020	1/5/30
6793 84	Wireless 4 Scenario Control Switch - 2 Module	7658	1/5/30

In Wall Wireless Switch

6793 87	In Wall Wireless Switch - 1 Module	5242	1/5/20
6793 95	In Wall Wireless Shutter Switch - 1 Module	6042	1/5/20
6793 93	In Wall Home/Away Wireless Switch - 1 Module	6134	1/5/20
6793 97	In Wall Wake Up/Sleep Wireless Switch - 1 Module	6134	1/5/20

Bold Cat.Nos are products normally available with Legrand (India) Stockists. Cat.Nos that are not bold - delivery within 4 - 8 weeks from the date of order. Bold packing quantity is our mandatory packing. Orders to be placed by Legrand (India) Stockist in multiples of the same.

Myrius™ IoT Cover Plates

Cat.Nos	Description	MRP ₹ / Unit	Pack
---------	-------------	--------------------	------

Micro Module Switch

6793 89	Connected Micro Module Switch - with Neutral - Black	8130	1/5/50
---------	--	------	--------

Smart Plug

6793 90	6A - Smart Mobile Plug	10348	5/20
6793 91	16A - Smart Mobile Plug	11146	5/21



6793 91



6795 02



6795 04

Cover Plate with Support Frame - Classic White

6795 01	Cover Plate + Support Frame - 1 Module - Classic White	248	20/200
6795 02	Cover Plate + Support Frame - 2 Module - Classic White	258	20/200
6795 03	Cover Plate + Support Frame - 3 Module - Classic White	272	10/100
6795 04	Cover Plate + Support Frame - 4 Module - Classic White	304	10/100
6795 06	Cover Plate + Support Frame - 6 Module - Classic White	526	5/50
6795 08	Cover Plate + Support Frame - 8 Module - Classic White	576	5/50
6795 09	Cover Plate + Support Frame - 2*4 Module - Classic White	732	5/25
6795 10	Cover Plate + Support Frame - 9 Module - Classic White	774	5/50
6795 12	Cover Plate + Support Frame - 12 Module - Classic White	878	10
6795 16	Cover Plate + Support Frame - 16 Module - Classic White	1022	10
6795 17	Cover Plate + Support Frame - 16 Module(Big) - Classic White	1108	1/10
6795 18	Cover Plate + Support Frame - 18 Module - Classic White	1172	10

Cover Plate with Support Frame - Ice White

6795 21	Cover Plate + Support Frame - 1 Module - Ice White	352	1/5/30
6795 22	Cover Plate + Support Frame - 2 Module - Ice White	372	1/5/30
6795 23	Cover Plate + Support Frame - 3 Module - Ice White	396	1/20
6795 24	Cover Plate + Support Frame - 4 Module - Ice White	422	1/20

* MRP - Maximum Retail Price Inclusive of all taxes including GST.

Myrius™ IoT Cover Plates

Cat.Nos	Description	MRP ₹ / Unit	Pack
---------	-------------	--------------------	------

Cover Plate with Support Frame - Ice White

6795 26	Cover Plate + Support Frame - 6 Module - Ice White	766	1/10
6795 28	Cover Plate + Support Frame - 8 Module - Ice White	834	1/10
6795 29	Cover Plate + Support Frame - 2*4 Module - Ice White	1044	1/5
6795 32	Cover Plate + Support Frame - 12 Module - Ice White	1270	1/5
6795 36	Cover Plate + Support Frame - 16 Module - Ice White	1478	1/5
6795 37	Cover Plate + Support Frame - 16 Module(Big) - Ice White	1566	1/5
6795 38	Cover Plate + Support Frame - 18 Module - Ice White	1694	1/5



6795 22



6795 23

Cover Plate with Support Frame - Ice Black

6795 41	Cover Plate + Support Frame - 1 Module - Ice Black	352	1/5/30
6795 42	Cover Plate + Support Frame - 2 Module - Ice Black	372	1/5/30
6795 43	Cover Plate + Support Frame - 3 Module - Ice Black	396	1/20
6795 44	Cover Plate + Support Frame - 4 Module - Ice Black	422	1/20
6795 46	Cover Plate + Support Frame - 6 Module - Ice Black	766	1/10
6795 48	Cover Plate + Support Frame - 8 Module - Ice Black	834	1/10
6795 49	Cover Plate + Support Frame - 2*4 Module - Ice Black	1044	1/5
6795 52	Cover Plate + Support Frame - 12 Module - Ice Black	1270	1/5
6795 56	Cover Plate + Support Frame - 16 Module - Ice Black	1478	1/5
6795 57	Cover Plate + Support Frame - 16 Module(Big) - Ice Black	1566	1/5
6795 58	Cover Plate + Support Frame - 18 Module - Ice Black	1694	1/5



6795 42



6795 44

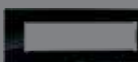

6795 48



6795 56

Bold Cat.Nos are products normally available with Legrand (India) Stockists. Cat.Nos that are not bold - delivery within 4 - 8 weeks from the date of order. Bold packing quantity is our mandatory packing. Orders to be placed by Legrand (India) Stockist in multiples of the same.

Myrius™ IoT Cover Plates

Cat.Nos	Description	MRP ₹ / Unit	Pack
---------	-------------	--------------------	------

Cover Plate with Support Frame - Charcoal Grey

6797 01	Cover Plate + Support Frame - 1 Module - Charcoal Grey	300	20/200
6797 02	Cover Plate + Support Frame - 2 Module - Charcoal Grey	314	20/200
6797 03	Cover Plate + Support Frame - 3 Module - Charcoal Grey	340	10/100
6797 04	Cover Plate + Support Frame - 4 Module - Charcoal Grey	364	10/100
6797 06	Cover Plate + Support Frame - 6 Module - Charcoal Grey	650	5/50
6797 08	Cover Plate + Support Frame - 8 Module - Charcoal Grey	708	5/50
6797 09	Cover Plate + Support Frame - 2*4 Module - Charcoal Grey	900	5/25
6797 10	Cover Plate + Support Frame - 9 Module - Charcoal Grey	966	5/50
6797 12	Cover Plate + Support Frame - 12 Module - Charcoal Grey	1082	1/10
6797 16	Cover Plate + Support Frame - 16 Module - Charcoal Grey	1252	1/10
6797 17	Cover Plate + Support Frame - 16 Module(Big) - Charcoal Grey	1348	1/10
6797 18	Cover Plate + Support Frame - 18 Module - Charcoal Grey	1440	1/10

Cover Plate with Support Frame - Pearl Champagne

6795 61	Cover Plate + Support Frame - 1 Module - Pearl Champagne	480	1/5/30
6795 62	Cover Plate + Support Frame - 2 Module - Pearl Champagne	508	1/5/30
6795 63	Cover Plate + Support Frame - 3 Module - Pearl Champagne	540	1/20
6795 64	Cover Plate + Support Frame - 4 Module - Pearl Champagne	584	1/20
6795 66	Cover Plate + Support Frame - 6 Module - Pearl Champagne	1044	1/10
6795 68	Cover Plate + Support Frame - 8 Module - Horizontal - Pearl Champagne	1140	1/10

* MRP - Maximum Retail Price Inclusive of all taxes including GST.

Myrius™ IoT Cover Plates

Cat.Nos	Description	MRP ₹ / Unit	Pack
---------	-------------	--------------------	------

Cover Plate with Support Frame - Pearl Champagne

6795 69	Cover Plate + Support Frame - 2*4 Module - Vertical - Pearl Champagne	1428	1/5
6795 72	Cover Plate + Support Frame - 12 Module - Pearl Champagne	1728	1/5
6795 76	Cover Plate + Support Frame - 16 Module - Pearl Champagne	2010	1/5
*6795 77	Cover Plate + Support Frame - 16 Module(Big) - Pearl Champagne	2134	1/5
6795 78	Cover Plate + Support Frame - 18 Module - Pearl Champagne	2314	1/5

Cover Plate with Support Frame - Sonic Silver

6795 81	Cover Plate + Support Frame - 1 Module - Sonic Silver	480	1/5/30
6795 82	Cover Plate + Support Frame - 2 Module - Sonic Silver	508	1/5/30
6795 83	Cover Plate + Support Frame - 3 Module - Sonic Silver	540	1/20
6795 84	Cover Plate + Support Frame - 4 Module - Sonic Silver	584	1/20
6795 86	Cover Plate + Support Frame - 6 Module - Sonic Silver	1044	1/10
6795 88	Cover Plate + Support Frame - 8 Module - Horizontal - Sonic Silver	1140	1/10
6795 89	Cover Plate + Support Frame - 2*4 Module - Vertical - Sonic Silver	1428	1/5
6795 92	Cover Plate + Support Frame - 12 Module - Sonic Silver	1728	1/5
6795 96	Cover Plate + Support Frame - 16 Module - Sonic Silver	2010	1/5
*6795 97	Cover Plate + Support Frame - 16 Module(Big) - Sonic Silver	2134	1/5
6795 98	Cover Plate + Support Frame - 18 Module - Sonic Silver	2314	1/5

Bold Cat.Nos are products normally available with Legrand (India) Stockists. Cat.Nos that are not bold - delivery within 4 - 8 weeks from the date of order. Bold packing quantity is our mandatory packing. Orders to be placed by Legrand (India) Stockist in multiples of the same.

Myrius™ IoT Cover Plates

Cat.Nos	Description	MRP ₹ / Unit	Pack
---------	-------------	--------------------	------

Cover Plate with Support Frame - Dark Fade

6796 01	Cover Plate + Support Frame - 1 Module - Dark Fade	480	1/5/30
6796 02	Cover Plate + Support Frame - 2 Module - Dark Fade	508	1/5/30
6796 03	Cover Plate + Support Frame - 3 Module - Dark Fade	540	1/20
6796 04	Cover Plate + Support Frame - 4 Module - Dark Fade	584	1/20
6796 06	Cover Plate + Support Frame - 6 Module - Dark Fade	1044	1/10
6796 08	Cover Plate + Support Frame - 8 Module - Horizontal - Dark Fade	1140	1/10
6796 09	Cover Plate + Support Frame - 2*4 Module - Vertical - Dark Fade	1428	1/5
6796 12	Cover Plate + Support Frame - 12 Module - Dark Fade	1728	1/5
6796 16	Cover Plate + Support Frame - 16 Module - Dark Fade	2010	1/5
*6796 17	Cover Plate + Support Frame - 16 Module(Big) - Dark Fade	2134	1/5
6796 18	Cover Plate + Support Frame - 18 Module - Dark Fade	2314	1/5

Cover Plate with Support Frame - Ice Graphite

6797 21	Cover Plate + Support Frame - 1 Module - Ice Graphite	352	1/5/30
6797 22	Cover Plate + Support Frame - 2 Module - Ice Graphite	372	1/5/30
6797 23	Cover Plate + Support Frame - 3 Module - Ice Graphite	396	1/20
6797 24	Cover Plate + Support Frame - 4 Module - Ice Graphite	422	1/20
6797 26	Cover Plate + Support Frame - 6 Module - Ice Graphite	766	1/10

Myrius™ IoT Cover Plates

Cat.Nos	Description	MRP ₹ / Unit	Pack
---------	-------------	--------------------	------

6797 28	Cover Plate + Support Frame - 8 Module - Horizontal - Ice Graphite	834	1/10
6797 29	Cover Plate + Support Frame - 2*4 Module - Vertical - Ice Graphite	1046	1/5
6797 32	Cover Plate + Support Frame - 12 Module - Ice Graphite	1264	1/5
6797 36	Cover Plate + Support Frame - 16 Module - Ice Graphite	1476	1/5
*6797 37	Cover Plate + Support Frame - 16 Module(Big) - Ice Graphite	1566	1/5
6797 38	Cover Plate + Support Frame - 18 Module - Ice Graphite	1694	1/5

Cover Plate with Support Frame - Ice Silk

6797 41	Cover Plate + Support Frame - 1 Module - Ice Silk	352	1/5/30
6797 42	Cover Plate + Support Frame - 2 Module - Ice Silk	372	1/5/30
6797 43	Cover Plate + Support Frame - 3 Module - Ice Silk	396	1/20
6797 44	Cover Plate + Support Frame - 4 Module - Ice Silk	422	1/20
6797 46	Cover Plate + Support Frame - 6 Module - Ice Silk	766	1/10
6797 48	Cover Plate + Support Frame - 8 Module - Horizontal - Ice Silk	834	1/10
6797 49	Cover Plate + Support Frame - 2*4 Module - Vertical - Ice Silk	1046	1/5
6797 62	Cover Plate + Support Frame - 12 Module - Ice Silk	1264	1/5
6797 56	Cover Plate + Support Frame - 16 Module - Ice Silk	1476	1/5
*6797 67	Cover Plate + Support Frame - 16 Module(Big) - Ice Silk	1566	1/5
6797 68	Cover Plate + Support Frame - 18 Module - Ice Silk	1694	1/5

* MRP - Maximum Retail Price Inclusive of all taxes including GST.
Red Cat.Nos - new products & will be coming soon

Bold Cat.Nos are products normally available with Legrand (India) Stockists. Cat.Nos that are not bold - delivery within 4 - 8 weeks from the date of order. Bold packing quantity is our mandatory packing. Orders to be placed by Legrand (India) Stockist in multiples of the same.

Myrius™ IoT

Cover Plates

Cat.Nos	Description	MRP ₹ / Unit	Pack
Cover Plate with Support Frame - White Glass			
6798 11	Cover Plate + Support Frame - 1 Module - White Glass	1274	1/5/30
6798 12	Cover Plate + Support Frame - 2 Module - White Glass	1296	1/5/30
6798 13	Cover Plate + Support Frame - 3 Module - White Glass	1370	1/20
6798 14	Cover Plate + Support Frame - 4 Module - White Glass	1542	1/20
6798 16	Cover Plate + Support Frame - 6 Module - White Glass	1686	1/10
6798 18	Cover Plate + Support Frame - 8 Module - Horizontal - White Glass	1826	1/10
6798 19	Cover Plate + Support Frame - 2*4 Module - Vertical - White Glass	2232	1/5
6798 22	Cover Plate + Support Frame - 12 Module - White Glass	2842	1/5
6798 26	Cover Plate + Support Frame - 16 Module - White Glass	5022	1/5
6798 28	Cover Plate + Support Frame - 18 Module - White Glass	6226	1/5

Cover Plate with Support Frame - Black Glass

6798 31	Cover Plate + Support Frame - 1 Module - Black Glass	1274	1/5/30
6798 32	Cover Plate + Support Frame - 2 Module - Black Glass	1296	1/5/30
6798 33	Cover Plate + Support Frame - 3 Module - Black Glass	1370	1/20
6798 34	Cover Plate + Support Frame - 4 Module - Black Glass	1542	1/20

Myrius™ IoT

Cover Plates

Cat.Nos	Description	MRP ₹ / Unit	Pack
6798 36	Cover Plate + Support Frame - 6 Module - Black Glass	1686	1/10
6798 38	Cover Plate + Support Frame - 8 Module - Horizontal - Black Glass	1826	1/10
6798 39	Cover Plate + Support Frame - 2*4 Module - Vertical - Black Glass	2232	1/5
6798 42	Cover Plate + Support Frame - 12 Module - Black Glass	2842	1/5
6798 46	Cover Plate + Support Frame - 16 Module - Black Glass	5022	1/5
6798 48	Cover Plate + Support Frame - 18 Module - Black Glass	6226	1/5

Cover Plates without Frame

6795 05	Cover Plate without Frame for Wireless switch - 2 Module - White	156	1/5/50
6795 25	Cover Plate without Frame for Wireless switch - 2 Module - Ice White	350	1/5/50
6795 45	Cover Plate without Frame for Wireless switch - 2 Module - Ice Black	350	1/5/50
6795 65	Cover Plate without Frame for Wireless switch - 2 Module - Pearl Champagne	482	1/5/50
6795 85	Cover Plate without Frame for Wireless switch - 2 Module - Sonic Silver	482	1/5/50
6796 05	Cover Plate without Frame for Wireless switch - 2 Module - Dark Fade	482	1/5/50

* MRP - Maximum Retail Price Inclusive of all taxes including GST.
Red Cat.Nos - new products & will be coming soon

Bold Cat.Nos are products normally available with Legrand (India) Stockists. Cat.Nos that are not bold - delivery within 4 - 8 weeks from the date of order. Bold packing quantity is our mandatory packing. Orders to be placed by Legrand (India) Stockist in multiples of the same.

Myrius™ IoT Cover Plates

Cat.Nos	Description	MRP* ₹ / Unit	Pack
---------	-------------	---------------------	------

Accessory













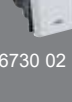

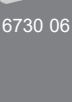

0648 71	Pack of 3*4 Extra Removable Stickers for Fixing A Wireless Control	806	1/25
---------	--	-----	------

* MRP - Maximum Retail Price Inclusive of all taxes including GST.

Bold Cat.Nos are products normally available with Legrand (India) Stockists. Cat.Nos that are not bold - delivery within 4 - 8 weeks from the date of order. Bold packing quantity is our mandatory packing. Orders to be placed by Legrand (India) Stockist in multiples of the same.

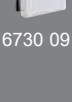
Myrius™ Regular



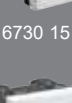















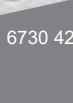

White Mechanism

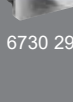
Cat.Nos	Description	MRP* ₹ / Unit	Pack
Switches – 6A - 230V AC			
 6730 00	6A - Switch - 1 Way - 1 Module	174	1/20/200
 6730 01	6A - Switch - 2 Way - 1 Module	306	1/20/200
 6730 02	6A - Switch - 1 Way - with Indicator - 1 Module	282	1/20/200
 6730 03	6A - Switch - 1 Way - with "Light" Marking - 1 Module	242	1/20/200
 6730 04	6A - Switch - 1 Way - with "Fan" Marking - 1 Module	252	1/20/200
Switches – 10A - 230V AC			
 6730 05	10A - Switch - 1 Way - 2 Module	364	1/10/100
 6730 06	10A - Switch - 2 Way - 2 Module	424	1/10/100
 6730 17	10A - Intermediate Switch - 230VA - 2 Module	2376	1/10/100
 6730 07	10A - Switch - 1 Way - with Indicator - 2 Module	448	1/10/100
Switches – 16A - 230V AC			
 6730 08	16A - Switch - 1 Way - 1 Module	414	1/20/200
 6730 09	16A - Switch - 2 Way - 1 Module	478	1/20/200
 6730 10	16A - Switch - 1 Way - with Indicator - 1 Module	500	1/20/200
Switches – 20A - 230V AC			
 6730 11	20A - Switch - 1 Way - 1 Module	544	1/20/200
 6730 12	20A - Switch - DP - 1 Way - 2 Module	822	1/10/100
 6730 13	20A - Switch - DP - 1 Way - with Indicator - 2 Module	876	1/10/100
 6730 14	20A - Switch - 2 Way - 2 Module	916	1/10/100
Switches – 25A - 230V AC			
 6730 15	25A - Switch - SP - 1 Way - with Indicator - 1 Module	606	1/20/200
Switches – 32A - 230V AC			
 6730 16	32A - Switch - DP - with Indicator - 2 Module	1418	1/10/100

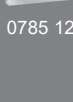
* MRP - Maximum Retail Price Inclusive of all taxes including GST.

Myrius™ Regular

White Mechanism

Cat.Nos	Description	MRP* ₹ / Unit	Pack
Push Buttons			
 6730 18	6A - Push Button - SP - 1 Module	354	1/20/200
 6730 19	6A - Push Button - SP - with Indicator - 1 Module	454	1/20/200
 6730 20	6A - Bell Push - 1 Module	340	1/20/200
 6730 21	6A - Bell Push - with Indicator - 1 Module	448	1/20/200
 6730 22	6A - Bell Push - 2 Module	514	1/10/100
 6730 23	6A - Bell Push - with Indicator - 2 Module	606	1/10/100
Accessory for Switch with Indicator			
 6732 44	Lamp for Switches/Push Buttons	88	5/50
Indian Standard Sockets			
 6731 86	6A - Socket - with Shutter - 3 Pin - ISI - 2 Module	284	1/20/200
 6730 45	6/16A - Socket - with Shutter - ISI - 2 Module	642	1/10/100
 6730 83	6/16A - Socket - with Shutter - ISI - 3 Module	768	1/5/50
 6730 42	16A - Switched Socket - with Shutter - 3 Pin - 3 Module	1614	1/5/50
Dimmer and Fan Regulator			
 6730 24	Rotary Dimmer - 400 Watts - 1 Module	1564	5/50
 6730 25	Rotary Dimmer - 650 Watts - 3 Module	3292	1/10
 6730 26	Compact Fluorescent Lamp Dimmer - 2 Module	5144	1/10
 6730 27	Fan Step Regulator - 100 Watts - ISI - 1 Module	1208	5/50
 6730 29	Fan Step Regulator - 100 Watts - ISI - 2 Module	1390	10/100
 6730 28	Fan Step Regulator - 120 Watts - ISI - 2 Module	1494	10/100
 6730 77	Fan Step Regulator - for Energy Saving Fans - 2 Module	1464	10/100
Emergency Light			
 0785 12	Emergency Light Unit - 2 Module	6884	1/1
Indicators			
 0785 73	Triangular Bulkhead - Blue - 2 Module	366	1/1
 0785 71	Triangular Bulkhead - Colourless - 2 Module	366	1/1
0785 72	Triangular Bulkhead - Green - 2 Module	404	1/1
0785 70	Triangular Bulkhead - 2 Module - Red	404	1/1

Bold Cat.Nos are products normally available with Legrand (India) Stockists. Cat.Nos that are not bold - delivery within 4 - 8 weeks from the date of order. Bold packing quantity is our mandatory packing. Orders to be placed by Legrand (India) Stockist in multiples of the same.

Myrius™ Regular

White Mechanism

Cat.Nos	Description	MRP* ₹ / Unit	Pack
---------	-------------	------------------	------

Skirting Light

6730 36	Skirting Light - with White LED - 3 Module	1220	1/10/100
---------	--	------	----------



6730 36

Bell Indicator

6730 33	Bell Call Indicator - 240VA - 1 Module	1634	1/20/200
---------	--	------	----------



6730 33

Buzzer

6730 34	Buzzer - 230VA - 1 Module	1420	1/20/200
---------	---------------------------	------	----------



6730 34

Remote Wnit

6730 73	Remote Control Switch - 4 Module	12344	1/5/20
---------	----------------------------------	-------	--------



6730 73

Hospitality Funtions

Hotel Keycard Switch

6730 37	15A - Key Card Switch - Monobloc with Plate - 2 Module	5726	1/10
6732 37	15A - Key Card Switch - Monobloc with New Plate - 2 Module	6594	1/10
6730 38	Key Fob for Key Card Switch	298	1/10/100



6730 37



6730 38

Hotel "DND and MMR" functions

6730 39	External DND & MMR Control Unit - with Bell Push - 2 Module	2440	1/10/100
6730 40	Internal DND & MMR Control Unit - 2 Module	1628	1/10/100



6730 40

Shaver Socket

6730 49	Shaver Socket - 230V/120 - 230V - Monobloc with Plate - 4 Module	7262	1/5/20
6730 79	Shaver Socket - 230V/120 - 230V - Monobloc with New Plate - 4 Module	7618	1/5/20



6730 50

TV Socket

6730 50	TV Co - axial Socket - 1 Module	312	1/20/200
---------	---------------------------------	-----	----------



6730 52

Data & Voice Socket

6730 52	Telephone Socket - RJ11 - with Transparent Shutter - 1 Module	310	1/20/200
6730 53	Telephone Socket - Double RJ11 - with Shutter - 1 Module	476	1/20/200
6730 54	Information Socket - RJ45 - Cat 5E - UTP - Toolless Systems - 1 Module	626	1/20/200
6730 55	Information Socket - RJ45 - Cat 6 - UTP - 1 Module	977	1/20/200
6730 56	Information Socket - RJ45 - Cat 6 - UTP - 2 Module	942	1/10/100



6730 56

USB Chargers (IS13252 (Part 1) / IEC 60950-1)

6731 62	USB Charger - 1500mA - Type A - 1 Module	2190	1/10/100
---------	--	------	----------



6730 56

* MRP - Maximum Retail Price Inclusive of all taxes including GST.

Myrius™ Regular

White Mechanism

Cat.Nos	Description	MRP* ₹ / Unit	Pack
---------	-------------	------------------	------

Audio & Video Connector

6730 57	3*Female RCA - 1 Module	4270	1/10
---------	-------------------------	------	------



6730 57

Sound (Volume Controller)

6730 63	Suitable for 8Ohms - 3 Watts - (RNS) Speaker - 2 Module	2038	1/10/100
---------	---	------	----------



6730 63

Protectors and Accessories

Motor Starter

6730 30	16A - Motor Starter - 2 Module	996	1/10/100
6730 31	25A - Motor Starter - 2 Module	1024	1/10/100



6730 31

Modular MCB (IS : 60898-1:2002)

6730 64	16A - SP - Modular MCB - C Curve - 1 Module	592	1/10/100
6730 65	20A - SP - Modular MCB - C Curve - 1 Module	592	1/10/100
6732 05	25A - SP - Modular MCB - C Curve - 1 Module	592	1/10/100
6732 07	32A - SP - Modular MCB - C Curve - 1 Module	592	1/10/100



6730 64

Accessories

6730 60	Cable Outlet - 8mm - 1 Module	386	1/20/200
6730 61	Blanking Plate - 1 Module	80	1/40/400
6730 62	Blanking Plate - 2 Module	92	1/10/100
0802 90	Panel Mounting Support - 1 Module	266	10/200
0802 91	Panel Mounting Support - 2 Module	278	10/200



6730 60



6730 62

White Antibacterial- Mechanism

6730 84	6A - Switch - 1 Way - 1 Module	270	1/20/200
6730 85	6A - Switch - 2 Way - 1 Module	372	1/20/200
6730 86	6A - Bell Push - 1 Module	420	1/20/200
6730 89	16A - Switch - 1 Way - 1 Module	500	1/20/200
6730 90	16A - Switch - 2 Way - 1 Module	578	1/20/200
6730 92	Fan Regulator - 120 Watts - ISI - 2 Module	1884	10/100
6731 87	6A - Socket - 3 Pin - ISI - 2 Module	350	1/20/200
6730 95	6/16A - Socket - ISI - 3 Module	926	1/5/50
0787 00	Equipotential Socket - 1 Module - Anti - Bacterial	2024	1/10
6730 98	TV Co - axial Socket - 1 Module	384	1/20/200
6730 99	Telephone Socket - RJ11 - 1 Module	384	1/20/200
6730 81	Information Socket - RJ45 - Cat 6 - UTP - 1 Module	1139	1/20/200
6730 82	Blanking Plate - 1 Module	70	1/40/400



6730 84



6730 86



6730 95

Bold Cat.Nos are products normally available with Legrand (India) Stockists. Cat.Nos that are not bold - delivery within 4 - 8 weeks from the date of order. Bold packing quantity is our mandatory packing. Orders to be placed by Legrand (India) Stockist in multiples of the same.

Myrius™ Regular

White Antibacterial Mechanism

Cat.Nos	Description	MRP* ₹ / Unit	Pack
Antibacterial Accessories			
6732 45	Cover Plate with Support Frame - 1 Module	292	20/200
6732 46	Cover Plate with Support Frame - 2 Module	334	20/200
6732 47	Cover Plate with Support Frame - 3 Module	376	10/100
6732 48	Cover Plate with Support Frame - 4 Module	404	10/100
6732 49	Cover Plate with Support Frame - Horizontal - 8 Module	778	5/50
6732 50	Cover Plate with Support Frame - (4*2) 8 Module	980	5/25
6732 52	Cover Plate with Support Frame - 16 Module	1358	1/10

Myrius™ Regular

Black Mechanism

Cat.Nos	Description	MRP* ₹ / Unit	Pack
Switches – 6A - 230V AC			
6731 00	6A - Switch - 1 Way - 1 Module	220	1/20/200
6731 01	6A - Switch - 2 Way - 1 Module	352	1/20/200
6731 02	6A - Switch - 1 Way - with Indicator - 1 Module	384	1/20/200
6731 03	6A - Switch - 1 Way - with "Light" Marking - 1 Module	294	1/20/200
6731 04	6A - Switch - 1 Way - with "Fan" Marking - 1 Module	294	1/20/200
Switches – 10A - 230V AC			
6731 05	10A - Switch - 1 Way - 2 Module	442	1/10/100
6731 06	10A - Switch - 2 Way - 2 Module	478	1/10/100
6731 17	10A - Intermediate Switch - 230VA - 2 Module	2740	1/10/100
6731 07	10A - Switch - 1 Way - with Indicator - 2 Module	510	1/10/100
Switches – 16A - 230V AC			
6731 08	16A - Switch - 1 Way - 1 Module	460	1/20/200
6731 09	16A - Switch - 2 Way - 1 Module	556	1/20/200
6731 10	16A - Switch - 1 Way - with Indicator - 1 Module	578	1/20/200
Switches – 20A - 230V AC			
6731 11	20A - Switch - 1 Way - 1 Module	620	1/20/200
6731 12	20A - Switch - DP - 1 Way - 2 Module	976	1/10/100
6731 13	20A - Switch - DP - 1 Way - with Indicator - 2 Module	1030	1/10/100
6731 14	20A - Switch - 2 Way - 2 Module	1066	1/10/100

Myrius™ Regular

Black Mechanism

Cat.Nos	Description	MRP* ₹ / Unit	Pack
Switches – 25A - 230V AC			
6731 15	25A - Switch - SP - 1 Way - with Indicator - 1 Module	708	1/20/200
Switches – 32A - 230V AC			
6731 16	32A - Switch - DP - with Indicator - 2 Module	1640	1/10/100
Push Buttons			
6731 18	6A - Push Button - SP - 1 Module	408	1/20/200
6731 19	6A - Push Button - SP - with Indicator - 1 Module	516	1/20/200
6731 20	6A - Bell Push - 1 Module	388	1/20/200
6731 21	6A - Bell Push - with Indicator - 1 Module	516	1/20/200
6731 22	6A - Bell Push - 2 Module	598	1/10/100
6731 23	6A - Bell Push - with Indicator - 2 Module	708	1/10/100
Accessories for Switches with Indicator			
6732 44	Lamp for Switches/Push Buttons	88	5/50
Indian Standard Sockets			
6721 03	6A - Socket - with Shutter - 3 Pin - ISI - 2 Module	318	1/20/200
6731 45	6/16A - Socket - with Shutter - ISI - 2 Module	752	1/10/100
6731 83	6/16A - Socket - with Shutter - ISI - 3 Module	890	1/5/50
6731 42	16A - Switched Socket - with Shutter - 3 Pin - 3 Module	1876	1/5/50
Socket - Red			
6730 48	16A - Switched Socket - with Shutter - 3 Module - Red	1664	1/5/50
Dimmers & Regulators			
6731 24	Rotary Dimmer - 400 Watts - 1 Module	1796	5/50
6731 25	Rotary Dimmer - 650 Watts - 3 Module	3802	1/10
6731 27	Fan Step Regulator - 100 Watts - ISI - 1 Module	1424	5/50
6731 29	Fan Step Regulator - 100 Watts - ISI - 2 Module	1610	10/100
6731 28	Fan Step Regulator - 120 Watts - ISI - 2 Module	1768	10/100
6731 77	Fan Step Regulator - for Energy Saving Fans - 2 Module	1708	10/100

* MRP - Maximum Retail Price Inclusive of all taxes including GST.

Bold Cat.Nos are products normally available with Legrand (India) Stockists. Cat.Nos that are not bold - delivery within 4 - 8 weeks from the date of order. Bold packing quantity is our mandatory packing. Orders to be placed by Legrand (India) Stockist in multiples of the same.

Myrius™ Regular

Black Mechanism

Cat.Nos	Description	MRP* ₹ / Unit	Pack
---------	-------------	------------------	------

Skirting Light

6731 36	Skirting Light - with White LED - 3 Module	1406	1/10/100
---------	--	------	----------

Bell Indicator

6731 33	Bell Call Indicator - 240VA - 1 Module	1936	1/20/200
---------	--	------	----------

Buzzer

6731 34	Buzzer - 230VA - Sound Level 72Db At 1 Meter Distance - 1 Module	1662	1/20/200
---------	--	------	----------

Remote Unit

6731 73	Remote Control Switch - 4 Module	14328	1/5/20
---------	----------------------------------	-------	--------

Hospitality Functions

Hotel Keycard Switch

6731 37	15A - Key Card Switch - with Timedelay 30 Sec. - Monobloc with Plate - 2 Module	6570	1/10
6732 67	15A - Key Card Switch - Monobloc with New Plate - 2 Module	7672	1/10
6730 38	Key Fob for Key Card Switch	298	1/10/100

Hotel "DND and MMR" Functions

6731 39	External DND & MMR Control Unit - with Bell Push - 2 Module	2800	1/10/100
6731 40	Internal DND & MMR Control Unit - 2 Module	1868	1/10/100

Shaver Socket

6731 49	Shaver Socket - 220/240V - 50/60Hz - Monobloc with Plate - 4 Module	7966	1/5/20
6731 79	Shaver Socket - 230V/120 - 230V - Monobloc with New Plate - 4 Module	8382	1/5/20

TV Socket

6731 50	TV Co - axial Socket - 1 Module	384	1/20/200
---------	---------------------------------	-----	----------

Data & Voice Socket

6731 52	Telephone Socket - RJ11 - with Transparent Shutter - 1 Module	368	1/20/200
6731 53	Telephone Socket - Double RJ11 - with Shutter - 1 Module	564	1/20/200
6731 54	Information Socket - RJ45 - Cat 5E - 1 Module	686	1/20/200
6731 55	Information Socket - RJ45 - Cat 6 - UTP - 1 Module	1047	1/20/200
6731 56	Information Socket - RJ45 - Cat 6 - UTP - 2 Module	1055	1/10/100

Myrius™ Regular

Plates with Frame

Cat.Nos	Description	MRP* ₹ / Unit	Pack
---------	-------------	------------------	------

USB Chargers (IS13252 (Part 1) / IEC 60950-1)

6731 72	USB Charger - 1500mA - Type A - 1 Module	2522	1/10/100
---------	--	------	----------

Audio & Video Connector

6731 57	3*Female RCA - 1 Module	4916	1/10
6731 58	3 Pole XLR Sockets - 2 Module	4636	1/10/100

Sound

6731 63	Suitable for 8Ohms - 3 Watts - (RNS) Speaker - 2 Module	2364	1/10/100
---------	---	------	----------

Protectors & Accessories

Motor Starter

6731 30	16A - Motor Starter - 2 Module	1174	1/10/100
6731 31	25A - Motor Starter - 2 Module	1200	1/10/100

Modular MCB (IS : 60898-1:2002)

6731 64	16A - SP - Modular MCB - C Curve - 1 Module	688	1/10/100
6731 65	20A - SP - Modular MCB - C Curve - 1 Module	688	1/10/100

Accessories

6731 60	Cable Outlet - 8mm - 1 Module	466	1/20/200
6731 61	Blanking Plate - 1 Module	90	1/40/400

Cover plates with Support Frames

White Cover Plates with Support Frame

6732 01	Cover Plate - 1 Module - White	288	20/200
6732 02	Cover Plate - 2 Module - White	312	20/200
6732 03	Cover Plate - 3 Module - White	328	10/100
6732 04	Cover Plate - 4 Module - White	352	10/100
6732 06	Cover Plate - 6 Module - White	634	5/50
6732 08	Cover Plate - 8 Module - Horizontal - White	702	5/50
6732 09	Cover Plate - 2*4 Module - Vertical - White	872	5/25
6732 12	Cover Plate - 12 Module - White	1056	1/10
6732 16	Cover Plate - 16 Module - White	1220	1/10
6732 18	Cover Plate - 18 Module - White	1406	1/10



6731 63



6732 01



6732 03

* MRP - Maximum Retail Price Inclusive of all taxes including GST.

Bold Cat.Nos are products normally available with Legrand (India) Stockists. Cat.Nos that are not bold - delivery within 4 - 8 weeks from the date of order. Bold packing quantity is our mandatory packing. Orders to be placed by Legrand (India) Stockist in multiples of the same.

Myrius™ Regular

Plates with Frame

Cat.Nos	Description	MRP* ₹ / Unit	Pack
---------	-------------	------------------	------

New White Cover Plates with Support Frame*

6732 11	Cover Plate - 1 Module - New White	300	20/200
6732 42	Cover Plate - 2 Module - New White	318	20/200
6732 13	Cover Plate - 3 Module - New White	346	10/100
6732 14	Cover Plate - 4 Module - New White	366	10/100
6732 66	Cover Plate - 6 Module - New White	716	5/50
6732 68	Cover Plate - 8 Module - Horizontal - New White	764	5/50
6732 69	Cover Plate - 2*4 Module - Vertical - New White	958	5/25
6732 62	Cover Plate - 12 Module - New White	1162	1/10
6732 56	Cover Plate - 16 Module - New White	1352	1/10
6732 58	Cover Plate - 18 Module - New White	1552	1/10

Black Cover Plates with Support Frame

6732 21	Cover Plate - 1 Module - Black	496	20/200
6732 22	Cover Plate - 2 Module - Black	534	20/200
6732 23	Cover Plate - 3 Module - Black	566	10/100
6732 24	Cover Plate - 4 Module - Black	630	10/100
6732 26	Cover Plate - 6 Module - Black	1092	5/50
6732 28	Cover Plate - 8 Module - Horizontal - Black	1218	5/50
6732 29	Cover Plate - 2*4 Module - Vertical - Black	1500	5/25
6732 32	Cover Plate - 12 Module - Black	1790	1/10
6732 36	Cover Plate - 16 Module - Black	2100	1/10
6732 38	Cover Plate - 18 Module - Black	2380	1/10

New Black Cover Plates with Support Frame

6732 31	Cover Plate - 1 Module - New Black	562	20/200
6732 82	Cover Plate - 2 Module - New Black	618	20/200
6732 33	Cover Plate - 3 Module - New Black	662	10/100
6732 34	Cover Plate - 4 Module - New Black	716	10/100
6732 86	Cover Plate - 6 Module - New Black	1264	5/50
6732 88	Cover Plate - 8 Module - Horizontal - New Black	1380	5/50
6732 89	Cover Plate - 2*4 Module - Vertical - New Black	1724	5/25
6732 92	Cover Plate - 12 Module - New Black	2074	1/10
6732 96	Cover Plate - 16 Module - New Black	2418	1/10
6732 98	Cover Plate - 18 Module - New Black	2728	1/10

* MRP - Maximum Retail Price Inclusive of all taxes including GST.

Myrius™ Regular

Mounting Boxes

Cat.Nos	Description	MRP* ₹ / Unit	Pack
---------	-------------	------------------	------

Accessories

Metal Flush Boxes

6890 07	Metal Flush Box - 1/2 Module	170	40
6890 08	Metal Flush Box - 3 Module	170	40
6890 09	Metal Flush Box - 4 Module	226	40
6890 10	Metal Flush Box - 6 Module	358	40
6890 42	Metal Flush Box - 8 Module	416	40
6890 31	Metal Flush Box - 2*4 Module	414	20
6890 11	Metal Flush Box - 12/16 Module	624	10
6890 12	Metal Flush Box - 18/24 Module	788	10

Plastic Surface Boxes

6733 02	Plastic Surface Box - 1/2 Module	100	10/50
6733 03	Plastic Surface Box - 3 Module	114	5/35
6733 04	Plastic Surface Box - 4 Module	134	5/25
6733 06	Plastic Surface Box - 6 Module	172	1/10
6733 08	Plastic Surface Box - 8 Module	254	1/5
6733 05	Plastic Surface Box - 2*4 Module	240	1/5

Metal Surface Boxes

6890 21	Metal Surface Box - 12 Module (2 Rows*6)	600	1/6
6890 22	Metal Surface Box - 18 Module (3 Rows*6)	634	1/4

Bold Cat.Nos are products normally available with Legrand (India) Stockists. Cat.Nos that are not bold - delivery within 4 - 8 weeks from the date of order. Bold packing quantity is our mandatory packing. Orders to be placed by Legrand (India) Stockist in multiples of the same.

Myrius™

Guarantee

- The Company, at its discretion, will replace products if they have any manufacturing defect within 10 years for switches (without LED lamp) and power sockets. For all other **Myrius™** wiring accessories the guarantee will be 2 years.
- The above guarantee is applicable when the devices are used in Legrand metal flush boxes. Otherwise the guarantee period will be reduced by 50%.
- The guarantee is only applicable when the products are installed as per the Company's instructions and not tampered in any manner.
- The guarantee states the Company's entire liability. It does not extend to cover consequential loss or damage or installation costs arising from defective products.

Our switches are compliant with revised BIS standard (IS 3854:2023) requirements. Also, our switches are covered additionally for use on Self-Ballasted Lamp (SBL) loads.

SBL power rating as per IS3854:2023

Switch Rating	6A, 230V~	10A, 230V~	16A, 230V~	20A, 230V~
SBL power (Watt)	100 W	100 W	200 W	250 W

Mylinc™

A little touch of genius

Reliable Modular Wiring for Devices



Mylinc™ is a modular wiring accessories range designed and manufactured in India for residential and commercial installations. Combining dependable mechanisms with practical design, it delivers reliability, convenience, and aesthetically consistent electrical solutions.

Features

- Durable mechanisms tested for up to 1 lakh operations
- Installer-friendly design with Linc-Loc™ alignment, front removal, and orientation indicators
- Enhanced safety with finger-proof IP20 terminals and shuttered sockets
- Quality assurance and laser markings, ISI and CE certification

Benefits

- Ensures long-term reliability with certified and durable components
- Simplifies installation with alignment aids and easy access mechanisms
- Enhances electrical safety through protected terminals and compliant designs
- Supports modern spaces with integrated power, lighting, and connectivity solutions

Scan to know more about the product.



Product Range



Silver Alu



Pearl White



Dark Bronze



Matt Grey



White



Champagne

Myline™

White- Mechanism

Cat.Nos	Description	MRP* ₹ / Unit	Pack
---------	-------------	------------------	------

Switches and Accessories

Switches 6A - 230V AC

6755 01	6A - Switch - SP - 1 Way - 1 Module	112	20/400
6755 02	6A - Switch - SP - 2 Way - 1 Module	226	20/200
6755 03	6A - Switch - SP - 1 Way - with Indicator - 1 Module	254	20/200

Switches - 10A - 230V AC

6755 85	10A - Switch - 1 Way - 1 Module	122	20/400
675593	10A - Switch - 2 Way - 1 Module	236	20/200
675594	10A - Switch - 1 Way - with Indicator - 1 Module	266	20/200

Switches 16A - 230V AC

6755 11	16A - Switch - SP - 1 Way - 1 Module	256	20/200
6755 12	16A - Switch - SP - 2 Way - 1 Module	322	20/200
6755 13	16A - Switch - SP - 1 Way - with Indicator - 1 Module	336	20/200

Switch 25A - 230V AC

6759 68	25A - Switch - with Indicator - 1 Module	518	10/100
---------	--	-----	--------

Switches 32A - 230V AC

6755 26	32A - Switch - DP - 1 Way - with Indicator - 2 Module	764	10/100
---------	---	-----	--------

Push buttons 6A - 230V AC

6755 04	6A - Bell Push - SP - 1 Way - 1 Module	236	20/200
6755 06	6A - Bell Push - SP - 1 Way - with Indicator - 2 Module	468	10/100

Indian Standard Sockets

6755 51	6A - Socket - with Shutter - 3 Pin - ISI - 2 Module	310	20/200
6755 55	6/16A - Socket - with Shutter - 3 Pin - Combine - ISI - 2 Module	476	10/100

Bell Call Indicator & Register - 6A - 230V AC

6755 07	6A - Bell Call Indicator - SP - with Register - 1 Way - 1 Module	1378	20/200
---------	--	------	--------

Lighting Modules

6755 95	Indicator Light Red - 1 Module	326	20/200
6755 96	Indicator Light Orange - 1 Module	326	20/200

Skirting Light

6755 97	Skirting Light - with White LED - 3 Module	1044	10/100
6759 76	Skirting Light - with White LED - 2 Module	696	5/50

Myline™

White- Mechanism

Cat.Nos	Description	MRP* ₹ / Unit	Pack
---------	-------------	------------------	------

Dimmers and Fan Regulators

6755 35	Rotative Dimmer - 60/250 Watts - for Light - 2 Module	868	10/100
6755 33	Dimmer - 400 Watts - for Light - 1 Module	1102	1/5/50
6755 31	Fan Regulator - 100 Watts - Humfree - 0 - 4 Step - 1 Module	794	1/5/50
6759 64	Fan Regulator - 100 Watts - with 360° Rotation - ISI - 2 Module	986	10/100
6755 30	Fan Regulator - 100 Watts - Humfree - 0 - 4 Step - ISI - 2 Module	1062	10/100
6759 77	Fan Regulator - 8 Step ISI - 2 Module	1062	1/10/100
6759 78	Fan Regulator - BLDC - 2 Module [^]	1082	10/100

Buzzer

6755 40	Buzzer - 1 Module	786	20/200
---------	-------------------	-----	--------

Remote Unit

6759 75	Remote Control Unit with Remote - for 4 Switch & Fan Load - 4 Module	5370	1/5/20
---------	--	------	--------

Hospitality function

Hotel "DND and MMR" functions

6759 69	External DND & MMR Control Unit - with Bell Push - 2 Module	492	10/100
6755 57	Internal DND & MMR Control Unit - 2 Module	406	1/10/100

Hotel Keycard Switch

6755 60	15A Key Card Switch - 2 Module	4470	1/10
6730 38	Key Fob for Key Card Switch	298	1/10/100

Motor Starter

6759 65	16A - Motor Starter - 2 Module	848	1/10/100
---------	--------------------------------	-----	----------

Modular MCB (IS : 60898-1:2002)

6759 74	16A - SP - Modular MCB - 1 Module	562	1/10/100
6756 40	20A - SP - Modular MCB - 1 Module	562	1/10/100
6756 41	25A - SP - Modular MCB - 1 Module	562	1/10/100
6756 42	32A - SP - Modular MCB - 1 Module	562	1/10/100

Tv Sockets

6755 46	TV Co - axial Socket - 1 Module	264	20/200
---------	---------------------------------	-----	--------

* MRP - Maximum Retail Price Inclusive of all taxes including GST.

[^]Compatible with Atomberg (Efficio), Havells (Efficiencia neo), Orient (Aerostorm) as per 2023 fan models.

Bold Cat.Nos are products normally available with Legrand (India) Stockists. Cat.Nos that are not bold - delivery within 4 - 8 weeks from the date of order. Bold packing quantity is our mandatory packing. Orders to be placed by Legrand (India) Stockist in multiples of the same.

Mylinc™

White- Mechanism

Cat.Nos	Description	MRP* ₹ / Unit	Pack
---------	-------------	------------------	------

Data and Voice

6755 41	Telephone Socket - RJ11 - 1 Module	248	20/200
6755 44	Telephone Socket - Double RJ11 - 1 Module	416	20/200
6759 66	Information Socket - RJ45 - Cat 5E -UTP-with Shutter - 1 Module	562	20/200
6759 67	Information Socket - RJ45 - Cat 6 - UTP-with Shutter - 1 Module	818	20/200
675982	Information Socket - RJ45 - Cat 6A - STP with shutter - 1 Module	929	20/200

USB Chargers (IS13252(Part 1) / IEC 60950-1)

6758 20	USB Charger - 1500mA - Type A - 1 Module	1412	10/100
6755 80	Double USB Charger - 3000mA - Type A + C - 2 Module	3084	1/10/100
6757 95	USB Charger - Power Delivery - 30 Watts - Type C + C - 2 Module	6720	1/3/30
6757 96	USB Charger - Power Delivery - 45 Watts - Type C - 2 Module	8408	1/3/30

Accessories

6755 91	Cable Outlet - 8mm - 1 Module	224	20/200
6755 90	Blanking Plate - 1 Module	64	20/200
6755 92	Spare 12 Screws with Nuts	80	20/200

Modular Cover Plates with Support Frame

White Cover Plates with Support Frame

6755 61	Cover Plate + Support Frame - 1 Module - White	186	20/200
6755 62	Cover Plate + Support Frame - 2 Module - White	186	20/200
6755 63	Cover Plate + Support Frame - 3 Module - White	254	10/100
6755 64	Cover Plate + Support Frame - 4 Module - White	282	10/100
6755 66	Cover Plate + Support Frame - 6 Module - White	350	5/50
6755 67	Cover Plate + Support Frame - Horizontal - 8 Module - White	450	5/50
6755 68	Cover Plate + Support Frame - 2*4 Module - Vertical - White	458	1/25
6755 69	Cover Plate + Support Frame - 9 Module - White	538	5/50
6755 72	Cover Plate + Support Frame - 12 Module - White	660	10
6755 73	Cover Plate + Support Frame - 16 Module - White	770	10
6755 78	Cover Plate + Support Frame - 18 Module - White	1030	10

* MRP - Maximum Retail Price Inclusive of all taxes including GST.

Mylinc™

Matt Grey- Mechanism

Cat.Nos	Description	MRP* ₹ / Unit	Pack
---------	-------------	------------------	------

Switches – 6A - 230V AC

6763 01	6A - Switch - SP - 1 Way - 1 Module	132	20/200
6763 02	6A - Switch - SP - 2 Way - 1 Module	244	20/200
6763 03	6A - Switch - SP - 1 Way - with Indicator - 1 Module	286	20/200

Switches – 16A - 230V AC

6763 11	16A - Switch - SP - 1 Way - 1 Module	282	20/200
6763 12	16A - Switch - SP - 2 Way - 1 Module	350	20/200
6763 13	16A - Switch - SP - 1 Way - with Indicator - 1 Module	380	20/200

Switches – 25A - 230V AC

6763 41	25A - Switch - with Indicator - 1 Module	598	10/100
---------	--	-----	--------

Switches – 32A - 230V AC

6763 26	32A - Switch - DP - 1 Way - with Indicator - 2 Module	850	10/100
---------	---	-----	--------

Push Buttons – 6A - 230V AC

6763 04	6A - Bell Push - SP - 1 Way - 1 Module	256	20/200
6763 06	6A - Bell Push - SP - 1 Way - with Indicator - 2 Module	520	10/100

Indian Standard Sockets

6763 27	6A - Socket - with Shutter - 3 Pin - ISI - 2 Module	344	20/200
6763 05	6/16A - Socket - with Shutter - 3 Pin - Combine - ISI - 2 Module	512	10/100

Bell Call Indicator & Register - 6A - 230V AC

6763 07	6A - Bell Call Indicator - SP - with Register - 1 Way - 1 Module	1520	20/200
---------	--	------	--------

Lighting Modules

6763 14	Indicator Light Red - 1 Module	356	20/200
6763 15	Indicator Light Orange - 1 Module	356	20/200

Skirting Light

6763 16	Skirting Light - with White LED - 3 Module	1142	10/100
6763 10	Skirting Light - with White LED - 2 Module	770	5/50

Bold Cat.Nos are products normally available with Legrand (India) Stockists. Cat.Nos that are not bold - delivery within 4 - 8 weeks from the date of order. Bold packing quantity is our mandatory packing. Orders to be placed by Legrand (India) Stockist in multiples of the same.



6755 44



6759 66



6759 67



675982



6758 20



6755 80



6757 95



6757 96



6755 91



6755 90



6755 92



6755 61



6755 62



6755 63



6755 64



6763 01



6763 02



6763 03



6763 11



6763 12



6763 13



6763 41



6763 26



6763 04



6763 06



6763 27



6763 05



6763 07



6763 14



6763 15



6763 16

Myline™ Matt Grey- Mechanism

Cat.Nos	Description	MRP* ₹ / Unit	Pack
Dimmers and Fan Regulators			
6763 17	Rotative Dimmer - 60/250 Watts - for Light - 2 Module	958	10/100
6763 18	Rotative Dimmer - 60/400 Watts - 1 Module	1220	1/5/50
6763 20	Fan Regulator - 100 Watts - Humfree - 0 - 4 Step - 1 Module	868	1/5/50
6763 37	Fan Regulator - 100 Watts - with 360° Rotation - ISI - 2 Module	1084	10/100
6763 19	Fan Regulator - 100 Watts - Humfree - 0 - 4 Step - ISI - 2 Module	1166	10/100
6763 08	Fan Regulator - 8 Step - ISI - 2 Module	1162	1/10/100
6763 09	Fan Regulator - BLDC - 2 Module^	1184	10/100

Buzzer

6763 21	Buzzer - 1 Module	964	20/200
---------	-------------------	-----	--------

Remote Unit

6763 47	Remote Control Unit with Remote - for 4 Switch & Fan Load - 4 Module	5908	1/5/20
---------	--	------	--------

Hospitality Function

Hotel "DND and MMR" functions

6763 42	External DND & MMR Control Unit - with Bell Push - 2 Module	540	10/100
6763 23	Internal DND & MMR Control Unit - 2 Module	472	10/100

Hotel Keycard Switch

6736 24	15A Key Card Switch - 2 Module	4960	1/10
673038	Key Fob for Key Card Switch	298	1/10/100

Protection Devices

Motor Starter

6763 38	16A - Motor Starter - 2 Module	938	1/10/100
---------	--------------------------------	-----	----------

Modular MCB (IS : 60898-1:2002)

6763 46	16A - SP - Modular MCB - 1 Module	628	1/10/100
---------	-----------------------------------	-----	----------

Tv Sockets

6763 32	TV Co - axial Socket - 1 Module	302	20/200
---------	---------------------------------	-----	--------

* MRP - Maximum Retail Price Inclusive of all taxes including GST.
^Compatible with Atomberg (Efficio), Havells (Efficiencia neo), Orient (Aerostorm) as per 2023 fan models.

Myline™ Matt Grey- Mechanism

Cat.Nos	Description	MRP* ₹ / Unit	Pack
Data and Voice			
6763 33	Telephone Socket - RJ11 - 1 Module	270	20/200
6763 34	Telephone Socket - Double RJ11 - 1 Module	446	20/200
6763 39	Information Socket - RJ45 - Cat 5E -UTP-with Shutter - 1 Module	603	20/200
6763 40	Information Socket - RJ45 - Cat 6 - UTP-with Shutter - 1 Module	924	20/200
675983	Information Socket - RJ45 - Cat 6A - STP with shutter - 1 Module	1072	20/200

USB Chargers (IS13252(Part 1) / IEC 60950-1)

6758 21	USB Charger - 1500mA - Type A - 1 Module	1554	10/100
6764 80	Double USB Charger - 3000mA - Type A + C - 2 Module	3538	1/10/100
6766 56	USB Charger - Power Delivery - 30 Watts - Type C + C - 2 Module	7232	1/3/30
6766 57	USB Charger - Power Delivery - 45 Watts - Type C - 2 Module	9402	1/3/30

Accessories

6763 48	Cable Outlet - 8mm - 1 Module	256	20/200
6763 49	Blanking Plate - 1 Module	72	20/200

Bold Cat.Nos are products normally available with Legrand (India) Stockists. Cat.Nos that are not bold - delivery within 4 - 8 weeks from the date of order. Bold packing quantity is our mandatory packing. Orders to be placed by Legrand (India) Stockist in multiples of the same.

Myline™ Cover Plate

Cat.Nos	Description	MRP* ₹ / Unit	Pack
---------	-------------	---------------------	------

Modular Cover Plates with Support Frame Matt Grey Cover Plates with Support Frame

6763 50	Cover Plate + Support Frame - 1 Module - Matt Grey	242	20/200
6763 51	Cover Plate + Support Frame - 2 Module - Matt Grey	242	20/200
6763 52	Cover Plate + Support Frame - 3 Module - Matt Grey	340	10/100
6763 53	Cover Plate + Support Frame - 4 Module - Matt Grey	358	10/100
6763 54	Cover Plate + Support Frame - 6 Module - Matt Grey	456	5/50
6763 55	Cover Plate + Support Frame - 8 Module - Horizontal - Matt Grey	588	5/50
6763 56	Cover Plate + Support Frame - 2*4 Module - Vertical - Matt Grey	602	5/25
6763 57	Cover Plate + Support Frame - 9 Module - Matt Grey	700	5/50
6763 58	Cover Plate + Support Frame - 12 Module - Matt Grey	854	10
6763 59	Cover Plate + Support Frame - 18 Module - Matt Grey	1354	10

Pearl White Cover Plates with Support Frame

6763 60	Cover Plate + Support Frame - 1 Module - Pearl White	230	10/100
6763 61	Cover Plate + Support Frame - 2 Module - Pearl White	230	10/100
6763 62	Cover Plate + Support Frame - 3 Module - Pearl White	304	10/100
6763 63	Cover Plate + Support Frame - 4 Module - Pearl White	332	10/100
6763 64	Cover Plate + Support Frame - 6 Module - Pearl White	436	5/50
6763 65	Cover Plate + Support Frame - 8 Module - Horizontal - Pearl White	550	5/50
6763 66	Cover Plate + Support Frame - 2*4 Module - Vertical - Pearl White	562	5/25
6763 67	Cover Plate + Support Frame - 9 Module - Pearl White	644	5/50
6763 68	Cover Plate + Support Frame - 12 Module - Pearl White	794	5/25
6763 69	Cover Plate + Support Frame - 18 Module - Pearl White	1244	5/25

Myline™ Cover Plate

Cat.Nos	Description	MRP* ₹ / Unit	Pack
---------	-------------	---------------------	------

Champagne Cover Plates with Support Frame

6763 70	Cover Plate + Support Frame - 1 Module - Champagne	230	10/100
6763 71	Cover Plate + Support Frame - 2 Module - Champagne	230	10/100
6763 72	Cover Plate + Support Frame - 3 Module - Champagne	304	10/100
6763 73	Cover Plate + Support Frame - 4 Module - Champagne	332	10/100
6763 74	Cover Plate + Support Frame - 6 Module - Champagne	436	5/50
6763 75	Cover Plate + Support Frame - 8 Module - Horizontal - Champagne	550	5/50
6763 76	Cover Plate + Support Frame - 2*4 Module - Vertical - Champagne	562	5/25
6763 77	Cover Plate + Support Frame - 9 Module - Champagne	644	5/50
6763 78	Cover Plate + Support Frame - 12 Module - Champagne	794	5/25
6763 79	Cover Plate + Support Frame - 18 Module - Champagne	1244	5/25

Silver Alu Cover Plates with Support Frame

6763 80	Cover Plate + Support Frame - 1 Module - Silver Alu	230	10/100
6763 81	Cover Plate + Support Frame - 2 Module - Silver Alu	230	10/100
6763 82	Cover Plate + Support Frame - 3 Module - Silver Alu	304	10/100
6763 83	Cover Plate + Support Frame - 4 Module - Silver Alu	332	10/100
6763 84	Cover Plate + Support Frame - 6 Module - Silver Alu	436	5/50
6763 85	Cover Plate + Support Frame - 8 Module - Horizontal - Silver Alu	550	5/50
6763 86	Cover Plate + Support Frame - 2*4 Module - Vertical - Silver Alu	562	5/25
6763 87	Cover Plate + Support Frame - 9 Module - Silver Alu	644	5/50
6763 88	Cover Plate + Support Frame - 12 Module - Silver Alu	794	5/25
6763 89	Cover Plate + Support Frame - 18 Module - Silver Alu	1244	5/25

* MRP - Maximum Retail Price Inclusive of all taxes including GST.

Bold Cat.Nos are products normally available with Legrand (India) Stockists. Cat.Nos that are not bold - delivery within 4 - 8 weeks from the date of order. Bold packing quantity is our mandatory packing. Orders to be placed by Legrand (India) Stockist in multiples of the same.

Myline™ Cover Plate

Cat.Nos	Description	MRP* ₹ / Unit	Pack
Dark Bronze Cover Plates with Support Frame			
6763 90	Cover Plate + Support Frame - 1 Module - Dark Bronze	230	10/100
6763 91	Cover Plate + Support Frame - 2 Module - Dark Bronze	230	10/100
6763 92	Cover Plate + Support Frame - 3 Module - Dark Bronze	304	10/100
6763 93	Cover Plate + Support Frame - 4 Module - Dark Bronze	332	10/100
6763 94	Cover Plate + Support Frame - 6 Module - Dark Bronze	436	5/50
6763 95	Cover Plate + Support Frame - 8 Module - Horizontal - Dark Bronze	550	5/50
6763 96	Cover Plate + Support Frame - 2*4 Module - Vertical - Dark Bronze	562	5/25
6763 97	Cover Plate + Support Frame - 9 Module - Dark Bronze	644	5/50
6763 98	Cover Plate + Support Frame - 12 Module - Dark Bronze	794	5/25
6763 99	Cover Plate + Support Frame - 18 Module - Dark Bronze	1244	5/25

Modular White Surrounds

6755 81	Modular Surrounds - 1 Module - White	60	20/200
6755 82	Modular Surrounds - 2 Module - White	96	20/200
6755 83	Modular Surrounds - 3 Module - White	96	10/100
6755 84	Modular Surrounds - 4 Module - White	148	10/100
6755 86	Modular Surrounds - 6 Module - White	216	10/100
6755 89	Modular Surrounds - 9 Module - White	368	10/100

Myline™ Boxes

Cat.Nos	Description	MRP* ₹ / Unit	Pack
Accessories			
Metal Flush Boxes			
6890 07	Metal Flush Box - 1/2 Module	170	40
6890 08	Metal Flush Box - 3 Module	170	40
6890 09	Metal Flush Box - 4 Module	226	40
6890 10	Metal Flush Box - 6 Module	358	40
6890 42	Metal Flush Box - 8 Module	416	40
6890 31	Metal Flush Box - 2*4 Module	414	20
6890 29	Metal Flush Box - 9 Module	490	20
6890 11	Metal Flush Box - 12/16 Module	624	10
6890 13	Metal Flush Box - 16 Module	720	10
6890 12	Metal Flush Box - 18 Module	788	10

Plastic Surface Boxes

6733 02	Plastic Surface Box - 1/2 Module	100	10/50
6733 03	Plastic Surface Box - 3 Module	114	5/35
6733 04	Plastic Surface Box - 4 Module	134	5/25
6733 06	Plastic Surface Box - 6 Module	172	1/10
6733 08	Plastic Surface Box - 8 Module	254	1/5
6733 05	Plastic Surface Box - 2*4 Module	240	1/5
6740 99	Plastic Surface Box - 9 Module	286	1/5

Metal Surface Boxes

6890 21	Metal Surface Box - 12 Module (2 Rows*6)	600	1/6
6890 22	Metal Surface Box - 18 Module (3 Rows*6)	634	1/4

* MRP - Maximum Retail Price Inclusive of all taxes including GST.

Bold Cat.Nos are products normally available with Legrand (India) Stockists. Cat.Nos that are not bold - delivery within 4 - 8 weeks from the date of order. Bold packing quantity is our mandatory packing. Orders to be placed by Legrand (India) Stockist in multiples of the same.

MylicincTM

A little touch of genius

A LITTLE TOUCH OF GENIUS



Guarantee

- The Company, at its discretion, will replace products if they have any manufacturing defect within 10 years for switches (without LED lamp) and power sockets. For all other **MylicincTM** wiring accessories the guarantee will be 2 years.
- The above guarantee is applicable when the devices are used in Legrand metal flush boxes. Otherwise the guarantee period will be reduced by 50%.
- The guarantee is only applicable when the products are installed as per the Company's instructions and not tampered in any manner.
- The guarantee states the Company's entire liability. It does not extend to cover consequential loss or damage or installation costs arising from defective products.

Our switches are compliant with revised BIS standard (IS 3854:2023) requirements. Also, our switches are covered additionally for use on Self-Ballasted Lamp (SBL) loads.

SBL power rating as per IS3854:2023

Switch Rating	6A, 230V~	10A, 230V~	16A, 230V~	20A, 230V~
SBL power (Watt)	100 W	100 W	200 W	250 W

Lyncus™

Upgrade to new

Elevate Your Home Experience



Lyncus™ is a contemporary modular wiring range designed for modern homes. With minimalist styling and versatile modules for power, control, and connectivity, it delivers practical solutions for everyday electrical needs.

Features

- Smart aesthetics with a signature notch that defines modern minimalism
- Switch range from 6–32A with indicator options
- Universally adaptable modules covering lighting, sockets, BLDC Fan regulator, USB charging, data communication, hospitality, and more.
- High durability design rated for long operational life cycles

Benefits

- Ensures dependable performance with high-quality engineering and long-term reliability
- Enhances interiors with a sleek and contemporary design
- Simplifies installation with user-friendly, tool-free fitting
- Enables design customization with a range of premium colour finishes

Scan to know more about the product.



Lyncus^M

Upgrade to new

Upgrade Your Home



White



Brushed Silver



Alu Sunset



Champagne



Matt Silver



USB Type C
- 20W PD
Fast Charging



USB Type A + C
- 15W



USB Type C + C
- 30W PD
Fast Charging



Remote Control Unit



Bluetooth Sound
Receiver



6/16A Socket
with Shutter (ISI)



Touch Fan
Regulator



Universal
Touch Dimmer



One Way
Touch Switch

Lyncus™

White Mechanism

Cat.Nos	Description	MRP* ₹ / Unit	Pack
---------	-------------	------------------	------

Switches - 6A - 230V AC

6772 00	6A - Switch - 1 Way - 1 Module	98	20/200
6772 01	6A - Switch - 2 Way - 1 Module	204	20/200
6772 02	6A - Switch - 1 Way - with Indicator - 1 Module	204	20/200
6772 03	6A - Switch - 1 Way - with "Light" Marking - 1 Module	184	20/200
6772 04	6A - Switch - 1 Way - with "Fan" Marking - 1 Module	184	20/200

Switches - 10A - 230V AC

6773 01	10A - Switch - 1 Way - 1 Module	106	20/200
6773 02	10A - Switch - 2 Way - 1 Module	208	20/200
6773 07	10A - Switch - 1 Way - with Indicator - 1 Module	208	20/200
6772 05	10A - Switch - 1 Way - 2 Module	244	10/100
6772 06	10A - Switch - 2 Way - 2 Module	292	10/100
6772 07	10A - Intermediate Switch - 2 Module	1666	10/100
6772 08	10A - Switch - 1 Way - with Indicator - 2 Module	320	10/100

Switches - 16A - 230V AC

6772 09	16A - Switch - 1 Way - 1 Module	236	20/200
6772 10	16A - Switch - 2 Way - 1 Module	290	20/200
6772 11	16A - Switch - 1 Way - with Indicator - 1 Module	300	20/200

Switches - 20A - 230V AC

6772 12	20A - Switch - 1 Way - 1 Module	346	20/200
6772 13	20A - Switch - DP - 1 Way - 2 Module	502	10/100
6772 14	20A - Switch - DP - 1 Way - with Indicator - 2 Module	512	10/100
6772 15	20A - Switch - 2 Way - 2 Module	568	10/100

Switches - 25A - 230V AC

6772 16	25A - Switch - SP - 1 Way - with Indicator - 1 Module	358	20/200
---------	---	-----	--------

Switches - 32A - 230V AC

6772 17	32A - Switch - DP - with Indicator - 2 Module	690	10/100
---------	---	-----	--------

Push Button - 6A - 230V AC

6772 18	6A - Push Button - SP - 1 Module	168	20/200
6772 19	6A - Push Button - SP - with Indicator - 1 Module	240	20/200
6772 20	6A - Bell Push - 1 Module	216	20/200
6772 21	6A - Bell Push - with Indicator - 1 Module	254	20/200
6772 22	6A - Bell Push - 2 Module	290	10/100
6772 23	6A - Bell Push - with Indicator - 2 Module	432	10/100

Accessory for Switch with Indicator

6772 24	LED Indicator for Switches	54	5/50
---------	----------------------------	----	------

Lyncus™

White Mechanism

Cat.Nos	Description	MRP* ₹ / Unit	Pack
---------	-------------	------------------	------

Indian Standard Sockets

6772 35	6A - Socket - with Shutter - 3 Pin - ISI - 2 Module	202	20/200
6772 30	6/16A - Socket - with Shutter - ISI - 2 Module	410	10/100
6772 29	6/16A - Socket - with Shutter - ISI - 3 Module	488	5/50
6772 26	16A - Switch + Socket - with Shutter - 3 Pin - 3 Module	772	5/50

Dimmers & Fan Regulators

6772 36	Rotary Light Dimmer - 400 Watts - 1 Module	742	5/50
6772 37	Rotary Light Dimmer - 500 Watts - 2 Module	952	10/100
6772 39	Fan Regulator - 100 Watts - ISI - 1 Module	680	5/50
6772 42	Fan step Regulator - 70 Watts - ISI - 2 Module	920	1/10/100
6772 40	Fan Regulator - 100 Watts - 360° - ISI - 2 Module	844	10/100
6772 41	Fan Regulator - 120 Watts - 360° - ISI - 2 Module	960	10/100
6772 44	Fan Regulator - 8 Step - 100 Watts - ISI - 2 Module	752	10/100
6772 45	Fan Regulator - BLDC - 2 Module [^]	924	10/100

Emergency Light

6772 43	Emergency Removable LED Lamp - 2 Module	3212	20/200
---------	---	------	--------

Skirting Light

6772 48	Skirting Light - with LED - 3 Module	666	10/100
---------	--------------------------------------	-----	--------

Indicator

6772 97	Indicator Unit - with Transparent LED & Colored Labels - 1 Module	470	10/100
---------	---	-----	--------

Bell Call Indicator

6772 49	Bell Call Indicator - 240V - 1 Module	1314	20/200
---------	---------------------------------------	------	--------

Buzzer

6772 50	Buzzer - 230V - 1 Module	752	20/200
---------	--------------------------	-----	--------

Infrared Sensors

6772 51	Infrared Sensor Switch - 400 Watts - 2 Module	1714	20/200
---------	---	------	--------

Remote Unit

6772 52	Remote Control Unit - for Light & Fan - 4 Module	5218	1/5/20
6773 03	Remote Control Hand Unit	838	1/5/30

Hospitality Function

Hotel Keycard Switch

6772 53	15A - Key Card Switch - 2 Module	4150	1/10
6772 55	Key Fob for Key Card Switch	140	10/100

Hotel "DND and MMR" Functions

6772 56	External DND & MMR Control Unit - with Bell Push - 2 Module	460	10/100
6772 57	Internal DND & MMR Control Unit - 2 Module	386	10/100

* MRP - Maximum Retail Price Inclusive of all taxes including GST.

[^] Compatible with Atomberg (Efficio), Havells (Efficiencia neo), Orient (Aerostorm) as per 2023 fan models.

Red Cat. Nos - New Products

Bold Cat.Nos are products normally available with Legrand (India) Stockists. Cat.Nos that are not bold - delivery within 4 - 8 weeks from the date of order. Bold packing quantity is our mandatory packing. Orders to be placed by Legrand (India) Stockist in multiples of the same.

Lyncus™

White Mechanism

Cat.Nos	Description	MRP* ₹ / Unit	Pack
---------	-------------	------------------	------

Shaver socket

6772 58	Shaver Socket - 120/240V - MonoBlock with Plate - 2 Module	3182	20/200
---------	--	------	--------

Sockets & Connectors

Tv Sockets

6772 60	TV Co - axial Socket - 1 Module	230	20/200
---------	---------------------------------	-----	--------

Data & voice

6772 62	Telephone Socket - RJ11 - 1 Module	216	20/200
6772 63	Telephone Socket - Double RJ11 - 1 Module	352	20/200
6772 64	Information Socket - RJ45 - Cat 5 - UTP -with Shutter - 1 Module	530	20/200
6772 65	Information Socket - RJ45 - Cat 6 - UTP -with Shutter - 1 Module	740	20/200
6773 20	Information Socket - RJ45 - CAT6A - STP with shutter - 1 Module	942	20/200

Audio Video Connectors

6772 67	Preterminated Audio/Video Connector - 1 Module	1731	1/10
6772 68	Preterminated HDMI Socket - 1 Module	2121	1/10
6772 69	Preterminated Projector Connector - 1 Module	2121	1/10

Sound (Volume controller)

6772 70	Volume Controller - 2 Module	1361	10/100
---------	------------------------------	------	--------

Protectors and Accessories

Motor Starter

6772 71	16A - Motor Starter - 2 Module	796	1/5/50
6772 72	25A - Motor Starter - 2 Module	796	1/5/50

VSP

6772 74	Voltage Surge Protector - 230V - 1 Module	2654	20/200
---------	---	------	--------

Modular MCB (IS : 608981:2002)

6772 81	16A - SP - Modular MCB - 1 Module	546	1/10/100
6772 82	20A - SP - Modular MCB - 1 Module	546	1/10/100
6772 83	32A - SP - Modular MCB - 1 Module	546	1/10/100

Lyncus™

White Mechanism

Cat.Nos	Description	MRP* ₹ / Unit	Pack
---------	-------------	------------------	------

Electronic Function

USB Chargers (IS13252 (Part 1) / IEC 60950-1)

6772 91	USB Charger - 1500mA - Type A - 1 Module	1356	10/100
6772 89	USB Charger - 3000mA - Type A + C - 2 Module	3028	1/10/100
6777 51	USB Charger - 3000mA/15 Watts - Type A - 1 Module	1986	1/5/50
6777 52	USB Charger - 3000mA/15 Watts - Type A + A - 1 Module	2206	1/5/50
6777 53	USB Charger - 3000mA/15 Watts - Type A + C - 1 Module	2526	1/5/50
6777 54	USB Charger - 3000mA/15 Watts - Type C + C - 1 Module	2762	1/5/50
6777 55	USB Charger - Power Delivery - 20 Watts - Type C - 1 Module	3824	1/5/50
6777 56	USB Charger - Power Delivery - 30 Watts - Type C + C - 2 Module	6562	1/3/30
6777 57	USB Charger - Power Delivery - 45W - Type C - 2 Module	8034	1/3/30
NEW! 6777 59	USB Charger - Power Delivery - 65W - Type C + C - 3 Module	9966	1/5/20

Loud Speakers

6772 98	Loudspeaker for False Ceiling & Plaster Board - 8Ohms - 10 Watts	2741	1/6
---------	--	------	-----

Sound Diffusion

6772 99*	Bluetooth Sound Diffusion - 2 Module	6033	1/10/100
----------	--------------------------------------	------	----------

Rotary Dimmer Universal

6773 04	Rotary LED Light Dimmer - 50 Watts - 1 Module	2740	1/10/100
---------	---	------	----------

Touch Switches

6773 09	6A - Touch Switch - 1 Way - 2 Module - Black	3782	1/50
6773 10	6A - Touch Switch - 2 Way - 2 Module - Black	4370	1/50
6773 13	16A - Touch Switch - 1 Way - 2 Module - Black	4370	1/50
6773 06	6A - Touch Bell Push - 2 Module - Black	3782	1/50

Touch Regulator & Dimmer

6773 05	Touch Fan Regulator - 100 Watts - 2 Module - Black	4370	1/50
6773 15	Universal LED Touch Light Scroll Dimming - 300 Watts - 2 Module - Black	4370	1/50

Reading Light

6773 16	Reading Light LED	2524	20/200
---------	-------------------	------	--------

* MRP - Maximum Retail Price Inclusive of all taxes including GST.
Red Cat. Nos - New Products

Bold Cat.Nos are products normally available with Legrand (India) Stockists. Cat.Nos that are not bold - delivery within 4 - 8 weeks from the date of order. Bold packing quantity is our mandatory packing. Orders to be placed by Legrand (India) Stockist in multiples of the same.

Lyncus™

White Mechanism

Cat.Nos	Description	MRP* ₹ / Unit	Pack
---------	-------------	------------------	------

Accessories

6772 75	Cable Outlet - 8mm - 1 Module	208	20/200
6772 76	Blanking Plate - 1 Module - Classic White	54	40/400
6772 77	Blanking Plate - 2 Module - Classic White	70	10/100

Chic Grey- Mechanism

Switches - 6A - 230V AC

6774 00	6A - Switch - 1 Way - 1 Module	118	20/200
6774 01	6A - Switch - 2 Way - 1 Module	236	20/200
6774 02	6A - Switch - 1 Way - with Indicator - 1 Module	238	20/200
6774 03	6A - Switch - 1 Way - with "Light" Marking - 1 Module	226	20/200
6774 04	6A - Switch - 1 Way - with "Fan" Marking - 1 Module	226	20/200

Switches - 10A - 230V AC

6774 05	10A - Switch - 1 Way - 2 Module	288	10/100
6774 06	10A - Switch - 2 Way - 2 Module	338	10/100
6774 07	10A - Intermediate Switch - 2 Module	1918	10/100
6774 08	10A - Switch - 1 Way - with Indicator - 2 Module	372	10/100

Switches - 16A - 230V AC

6774 09	16A - Switch - 1 Way - 1 Module	260	20/200
6774 10	16A - Switch - 2 Way - 1 Module	334	20/200
6774 11	16A - Switch - 1 Way - with Indicator - 1 Module	346	20/200

Switches - 20A - 230V AC

6774 12	20A - Switch - 1 Way - 1 Module	402	20/200
6774 13	20A - Switch - DP - 1 Way - 2 Module	580	10/100
6774 14	20A - Switch - DP - 1 Way - with Indicator - 2 Module	588	10/100
6774 15	20A - Switch - 2 Way - 2 Module	666	10/100

Switches - 25A - 230V AC

6774 16	25A - Switch - SP - 1 Way - with Indicator - 1 Module	414	20/200
---------	---	-----	--------

Switches - 32A - 230V AC

6774 17	32A - Switch - DP - with Indicator - 2 Module	794	10/100
---------	---	-----	--------

Push Button - 6A - 230V AC

6774 18	6A - Push Button - SP - 1 Module	192	20/200
6774 19	6A - Push Button - SP - with Indicator - 1 Module	272	20/200
6774 20	6A - Bell Push - 1 Module	250	20/200
6774 21	6A - Bell Push - with Indicator - 1 Module	296	20/200
6774 22	6A - Bell Push - 2 Module	334	10/100
6774 23	6A - Bell Push - with Indicator - 2 Module	494	10/100

Lyncus™

Chic Grey Mechanism

Cat.Nos	Description	MRP* ₹ / Unit	Pack
---------	-------------	------------------	------

Indian Standard Sockets

6774 35	6A - Socket - with Shutter - 3 Pin - ISI - 2 Module	232	20/200
6774 30	6/16A - Socket - with Shutter - ISI - 2 Module	474	10/100
6774 29	6/16A - Socket - with Shutter - ISI - 3 Module	564	5/50

Dimmers & Fan Regulators

6774 36	Rotary Light Dimmer - 400 Watts - 1 Module	854	5/50
6774 37	Rotary Light Dimmer - 500 Watts - 2 Module	1090	10/100
6774 39	Fan Regulator - 100 Watts - ISI - 1 Module	788	5/50
6774 42	Fan step Regulator - 70 Watts - ISI - 2 Module	1060	1/10/100
6774 40	Fan Regulator - 100 Watts - 360° - ISI - 2 Module	970	10/100
6774 41	Fan Regulator - 120 Watts - 360° - ISI - 2 Module	1102	10/100
6774 44	Fan Regulator - 8 Step - 100 Watts - ISI - 2 Module	880	10/100
6774 45	Fan Regulator - BLDC - 2 Module^	1070	10/100

Skirting Light

6774 48	Skirting Light - with LED - 3 Module	752	10/100
---------	--------------------------------------	-----	--------

Bell Call Indicator

6774 49	Bell Call Indicator - 240V - 1 Module	1482	20/200
---------	---------------------------------------	------	--------

Buzzer

6774 50	Buzzer - 230V - 1 Module	854	20/200
---------	--------------------------	-----	--------

Remote Unit

6774 52	Remote Control Unit - for Light & Fan - 4 Module	5602	1/5/20
6773 03	Remote Control Hand Unit	838	1/5/30

Hospitality Function

Hotel Keycard Switch

6774 53	15A - Key Card Switch - 2 Module	4682	1/10
6772 55	Key Fob for Key Card Switch	140	10/100

Hotel "DND and MMR" Functions

6774 56	External DND & MMR Control Unit - with Bell Push - 2 Module	528	10/100
6774 57	Internal DND & MMR Control Unit - 2 Module	460	10/100

Shaver Socket

6774 58	Shaver Socket - 120/240V - MonoBlock with Plate - 2 Module	3560	20/200
---------	--	------	--------

TV Sockets

6774 60	TV Co - axial Socket - 1 Module	262	20/200
---------	---------------------------------	-----	--------

* MRP - Maximum Retail Price Inclusive of all taxes including GST.

^Compatible with Atomberg (Efficio), Havells (Eficiencia neo), Orient (Aerostorm) as per 2023 fan models.

Bold Cat.Nos are products normally available with Legrand (India) Stockists. Cat.Nos that are not bold - delivery within 4 - 8 weeks from the date of order. Bold packing quantity is our mandatory packing. Orders to be placed by Legrand (India) Stockist in multiples of the same.

Lyncus™

Chic Grey Mechanism

Cat.Nos	Description	MRP* ₹ / Unit	Pack
---------	-------------	------------------	------

Data & Voice

6774 62	Telephone Socket - RJ11 - 1 Module	246	20/200
6774 63	Telephone Socket - Double RJ11 - 1 Module	416	20/200
6774 64	Information Socket - RJ45 - Cat 5 - UTP -with Shutter - 1 Module	580	20/200
6774 65	Information Socket - RJ45 - Cat 6 - UTP -with Shutter - 1 Module	892	20/200
6773 21	Information Socket - RJ45 - CAT6A - STP with shutter - 1 Module	1023	20/200

Audio Video Sockets

6774 67	Preterminated Audio/Video Connector - 1 Module	1994	1/10
6774 68	Preterminated HDMI Socket - 1 Module	2438	1/10
6774 69	Preterminated Projector Connector - 1 Module	2438	1/10

Sound (volume controller)

6774 70	Volume Controller - 2 Module	1572	1/10/100
---------	------------------------------	------	----------

Electronic Function

USB Chargers (IS13252 (Part 1) / IEC 609501)

6774 91	USB Charger - 1500mA - Type A - 1 Module	1540	1/5/50
6774 89	USB Charger - 3000mA - Type A + C - 2 Module	3480	1/10/100
6779 51	USB Charger - 3000mA/15 Watts - Type A - 1 Module	2214	1/5/50
6779 52	USB Charger - 3000mA/15 Watts - Type A + A - 1 Module	2480	1/5/50
6779 53	USB Charger - 3000mA/15 Watts - Type A + C - 1 Module	2808	1/5/50
6779 54	USB Charger - 3000mA/15 Watts - Type C + C - 1 Module	3066	1/5/50
6779 55	USB Charger - Power Delivery - 20 Watts - Type C - 1 Module	4276	1/5/50
6779 56	USB Charger - Power Delivery - 30 Watts - Type C + C - 2 Module	7188	1/3/30
6779 57	USB Charger - Power Delivery - 45W - Type C - 2 Module	8856	1/3/30
NEW! 6779 59	USB Charger - Power Delivery - 65W - Type C + C - 3 Module	10526	1/5/20

Sound Receiver

6774 99*	Bluetooth Sound Diffusion - 2 Module	6941	1/10/100
----------	--------------------------------------	------	----------

Rotary Dimmer Universal

6774 24	Rotary LED Dimmer - 50 Watts - 1 Module	3474	1/120
---------	---	------	-------

Accessories

6774 75	Cable Outlet - 8mm - 1 Module	246	20/200
6774 76	Blanking Plate - 1 Module	58	40/400

Lyncus™

Plate with Support Frame

Cat.Nos	Description	MRP* ₹ / Unit	Pack
---------	-------------	------------------	------

Cover Plates with Support Frame White Cover Plates with Support Frame

6775 01	Cover Plate + Support Frame - 1 Module - Classic White	170	20/200
6775 02	Cover Plate + Support Frame - 2 Module - Classic White	170	20/200
6775 03	Cover Plate + Support Frame - 3 Module - Classic White	218	10/100
6775 04	Cover Plate + Support Frame - 4 Module - Classic White	254	10/100
6775 06	Cover Plate + Support Frame - 6 Module - Classic White	308	5/50
6775 08	Cover Plate + Support Frame - 8 Module - Horizontal - Classic White	394	5/50
6775 09	Cover Plate + Support Frame - 2*4 Module - Vertical - Classic White	412	5/25
6775 10	Cover Plate + Support Frame - 9 Module - Classic White	438	5/50
6775 12	Cover Plate + Support Frame - 12 Module - Classic White	574	10
6775 16	Cover Plate + Support Frame - 16 Module - Classic White	668	10
6776 17	Cover Plate + Support Frame - 16 Module(Big) - Classic White	680	10
6775 18	Cover Plate + Support Frame - 18 Module - Classic White	902	10

* MRP - Maximum Retail Price Inclusive of all taxes including GST.
Red Cat. Nos - New Products

Bold Cat.Nos are products normally available with Legrand (India) Stockists. Cat.Nos that are not bold - delivery within 4 - 8 weeks from the date of order. Bold packing quantity is our mandatory packing. Orders to be placed by Legrand (India) Stockist in multiples of the same.

Lyncus™

Plate with Support Frame

Cat.Nos	Description	MRP* ₹ / Unit	Pack
Chic Grey Cover Plates with Support Frame			
6775 21	Cover Plate + Support Frame - 1 Module - Chic Grey	218	20/200
6775 22	Cover Plate + Support Frame - 2 Module - Chic Grey	218	20/200
6775 23	Cover Plate + Support Frame - 3 Module - Chic Grey	304	10/100
6775 24	Cover Plate + Support Frame - 4 Module - Chic Grey	322	10/100
6775 26	Cover Plate + Support Frame - 6 Module - Chic Grey	396	5/50
6775 28	Cover Plate + Support Frame - 8 Module - Horizontal - Chic Grey	540	5/50
6775 29	Cover Plate + Support Frame - 2*4 Module - Vertical - Chic Grey	540	5/25
6775 30	Cover Plate + Support Frame - 9 Module - Chic Grey	582	5/50
6775 32	Cover Plate + Support Frame - 12 Module - Chic Grey	754	10
6775 36	Cover Plate + Support Frame - 16 Module - Chic Grey	868	10
6776 37	Cover Plate + Support Frame - 16 Module (Big) - Chic Grey	874	10
6775 38	Cover Plate + Support Frame - 18 Module - Chic Grey	1184	10

Lyncus™

Plate with Support Frame

Cat.Nos	Description	MRP* ₹ / Unit	Pack
Brushed Silver Cover Plates with Support Frame			
6775 41	Cover Plate + Support Frame - 1 Module - Brushed Silver	224	20/200
6775 42	Cover Plate + Support Frame - 2 Module - Brushed Silver	224	20/200
6775 43	Cover Plate + Support Frame - 3 Module - Brushed Silver	322	10/100
6775 44	Cover Plate + Support Frame - 4 Module - Brushed Silver	332	10/100
6775 46	Cover Plate + Support Frame - 6 Module - Brushed Silver	426	5/50
6775 48	Cover Plate + Support Frame - 8 Module - Horizontal - Brushed Silver	552	5/50
6775 49	Cover Plate + Support Frame - 2*4 Module - Vertical - Brushed Silver	552	5/25
6775 50	Cover Plate + Support Frame - 9 Module - Brushed Silver	606	5/50
6775 52	Cover Plate + Support Frame - 12 Module - Brushed Silver	790	10
6775 56	Cover Plate + Support Frame - 16 Module - Brushed Silver	914	10
6776 57	Cover Plate + Support Frame - 16 Module (Big) - Brushed Silver	926	10
6775 58	Cover Plate + Support Frame - 18 Module - Brushed Silver	1244	10

* MRP - Maximum Retail Price Inclusive of all taxes including GST.

Bold Cat.Nos are products normally available with Legrand (India) Stockists. Cat.Nos that are not bold - delivery within 4 - 8 weeks from the date of order. Bold packing quantity is our mandatory packing. Orders to be placed by Legrand (India) Stockist in multiples of the same.

Lyncus™

Plate with Support Frame

Cat.Nos	Description	MRP* ₹ / Unit	Pack
 6775 61	Cover Plate + Support Frame - 1 Module - Alu SunSet	220	20/200
 6775 62	Cover Plate + Support Frame - 2 Module - Alu SunSet	220	20/200
 6775 63	Cover Plate + Support Frame - 3 Module - Alu SunSet	304	10/100
 6775 64	Cover Plate + Support Frame - 4 Module - Alu SunSet	330	10/100
 6775 66	Cover Plate + Support Frame - 6 Module - Alu SunSet	418	5/50
 6775 68	Cover Plate + Support Frame - 8 Module - Horizontal - Alu SunSet	540	5/50
 6775 69	Cover Plate + Support Frame - 2*4 Module - Vertical - Alu SunSet	544	5/25
 6775 70	Cover Plate + Support Frame - 9 Module - Alu SunSet	582	5/50
 6775 72	Cover Plate + Support Frame - 12 Module - Alu SunSet	768	10
6775 76	Cover Plate + Support Frame - 16 Module - Alu SunSet	888	10
6776 77	Cover Plate + Support Frame - 16 Module(Big) - Alu SunSet	894	10
6775 78	Cover Plate + Support Frame - 18 Module - Alu SunSet	1220	10

* MRP - Maximum Retail Price Inclusive of all taxes including GST.

Lyncus™

Plate with Support Frame

Cat.Nos	Description	MRP* ₹ / Unit	Pack
 6775 81	Cover Plate + Support Frame - 1 Module - Champagne	220	20/200
 6775 82	Cover Plate + Support Frame - 2 Module - Champagne	220	20/200
 6775 83	Cover Plate + Support Frame - 3 Module - Champagne	304	10/100
 6775 84	Cover Plate + Support Frame - 4 Module - Champagne	330	10/100
 6775 86	Cover Plate + Support Frame - 6 Module - Champagne	418	5/50
 6775 88	Cover Plate + Support Frame - 8 Module - Horizontal - Champagne	540	5/50
 6775 89	Cover Plate + Support Frame - 2*4 Module - Vertical - Champagne	544	5/25
 6775 90	Cover Plate + Support Frame - 9 Module - Champagne	582	5/50
 6775 92	Cover Plate + Support Frame - 12 Module - Champagne	768	10
6775 96	Cover Plate + Support Frame - 16 Module - Champagne	888	10
6776 97	Cover Plate + Support Frame - 16 Module(Big) - Champagne	894	10
6775 98	Cover Plate + Support Frame - 18 Module - Champagne	1220	10

Bold Cat.Nos are products normally available with Legrand (India) Stockists. Cat.Nos that are not bold - delivery within 4 - 8 weeks from the date of order. Bold packing quantity is our mandatory packing. Orders to be placed by Legrand (India) Stockist in multiples of the same.

Lyncus™

Plate with Support Frame

Cat.Nos	Description	MRP* ₹ / Unit	Pack
Matt Silver Cover Plates with Support Frame			
6776 01	Cover Plate + Support Frame - 1 Module - Matt Silver	220	20/200
6776 02	Cover Plate + Support Frame - 2 Module - Matt Silver	220	20/200
6776 03	Cover Plate + Support Frame - 3 Module - Matt Silver	304	10/100
6776 04	Cover Plate + Support Frame - 4 Module - Matt Silver	330	10/100
6776 06	Cover Plate + Support Frame - 6 Module - Matt Silver	418	5/50
6776 08	Cover Plate + Support Frame - 8 Module - Horizontal - Matt Silver	540	5/50
6776 09	Cover Plate + Support Frame - 2*4 Module - Vertical - Matt Silver	544	5/25
6776 10	Cover Plate + Support Frame - 9 Module - Matt Silver	582	5/50
6776 12	Cover Plate + Support Frame - 12 Module - Matt Silver	768	10
6776 16	Cover Plate + Support Frame - 16 Module - Matt Silver	888	10
6776 67	Cover Plate + Support Frame - 16 Module(Big) - Matt Silver	894	10
6776 18	Cover Plate + Support Frame - 18 Module - Matt Silver	1220	10

Accessories

Metal Flush Boxes

6890 07	Metal Flush Box - 1/2 Module	170	40
6890 08	Metal Flush Box - 3 Module	170	40
6890 09	Metal Flush Box - 4 Module	226	40
6890 10	Metal Flush Box - 6 Module	358	40
6890 42	Metal Flush Box - 8 Module	416	40
6890 31	Metal Flush Box - 2*4 Module	414	20
6890 29	Metal Flush Box - 9 Module	490	20
6890 11	Metal Flush Box - 12/16 Module	624	10
6890 13	Metal Flush Box - 16 Module	720	10
6890 12	Metal Flush Box - 18 Module	788	10

* MRP - Maximum Retail Price Inclusive of all taxes including GST.

Lyncus™

Boxes

Cat.Nos	Description	MRP* ₹ / Unit	Pack
---------	-------------	------------------	------

Plastic Surface Boxes

6733 02	Plastic Surface Box - 1/2 Module	100	10/50
6733 03	Plastic Surface Box - 3 Module	114	5/35
6733 04	Plastic Surface Box - 4 Module	134	5/25
6733 06	Plastic Surface Box - 6 Module	172	1/10
6733 08	Plastic Surface Box - 8 Module	254	1/5
6733 05	Plastic Surface Box - 2*4 Module	240	1/5
6740 99	Plastic Surface Box - 9 Module	286	1/5

Metal Surface Boxes

6890 21	Metal Surface Box - 12 Module (2 Rows*6)	600	1/6
6890 22	Metal Surface Box - 18 Module (3 Rows*6)	634	1/4

LyncusTM

Change to today

Guarantee

- The Company, at its discretion, will replace products if they have any manufacturing defect within 10 years for switches (without LED lamp) and power sockets. For all other **LyncusTM** wiring accessories the guarantee will be 2 years.
- The above guarantee is applicable when the devices are used in Legrand metal flush boxes. Otherwise the guarantee period will be reduced by 50%.
- The guarantee is only applicable when the products are installed as per the Company's instructions and not tampered in any manner.
- The guarantee states the Company's entire liability. It does not extend to cover consequential loss or damage or installation costs arising from defective products.

Our switches are compliant with revised BIS standard (IS 3854:2023 requirements). Also, our switches are covered additionally for use on Self-Ballasted Lamp (SBL) loads.

SBL power rating as per IS3854:2023

Switch Rating	6A, 230V~	10A, 230V~	16A, 230V~	20A, 230V~
SBL power (Watt)	100 W	100 W	200 W	250 W

Allzy™

The All-Rounder Switch Range



Allzy™ is a versatile modular switch range designed for modern Indian homes and workplaces. Combining stylish finishes, versatile modules, and dependable performance, it delivers convenient solutions for power, charging, connectivity, and everyday control.

Features

- Durable switch mechanisms tested for 1 lakh on/off operations
- Comprehensive switch range upto 32A rating with low-noise rockers, regulators and dimmers
- 6A, 6/16A sockets shuttered also offering complete USB charging needs for everyday usage
- Connectivity modules RJ11, RJ45, HDMI, AV and projector sockets
- Convenience & hospitality controls such as remote control units, switches, and MMR modules

Benefits

- Enhances interiors with five stylish plate finishes and dual mechanism colours
- Ensures dependable safety with shuttered sockets, certified components, and durable performance testing
- Enables seamless connectivity for communication, entertainment, and presentations
- Improves convenience through rapid USB charging solutions



Colour Plates:



Scan to know more about the product.



Allzy

The All-rounder Switch

Live the Advantage
of an All-Rounder.

Range

SWITCHES



6A Switch 1W-
Light Marking



6A Switch 1W-
Fan Marking



20A DP Switch 1W-
Indicator Marking



6A Bell Push 1W-
Indicator Marking



Gold- Plate & Frame



Aluminium Champagne-
Plate & Frame



Rose Gold-Plate & Frame



White-Plate & Frame



Matt Black-Plate & Frame

SOCKETS

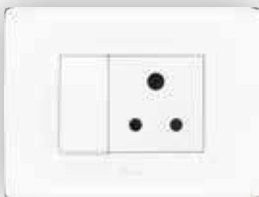

6A 3 Pin Socket with Shutter
- ISI Mark



6/16A Socket with shutter
- ISI Mark

ELECTRONICS



Fan Regulator 8 step 100W
- ISI Mark



Fan Regulator 360° 100W
- ISI Mark



Rotary Dimmer 500W



Remote Control Unit

USB



Type A + C 3A, 1M Type A + C 3A, 2M Type C 20W PD, 1M Type C + C 30W PD, 2M Type C 45W PD, 2M* Type C + C 65W PD, 3M*

*45 & 65W COMPATIBLE FOR LAPTOP CHARGING

VOICE & DATA COMMUNICATIONS



Double RJ11 Telephone Socket (with Shutter) RJ11 Telephone Socket (with Shutter) RJ45 Cat6 UTP Socket (with Shutter)

AUDIO VIDEO CONNECTOR



Preterminated Audio Video Connector Preterminated HDMI Socket

PROTECTION



Power Unit with 20A MCB & 16A Plug 32A Modular MCB DP 16A Motor starter

HOSPITALITY



Key card 15A switch-Card 230V 32A DP Key tag switch (Mechanical) Shaver Socket 120/230V AC with plate DND & MMR indicator-6A bell push (Outside) DND & MMR (Inside)

White - Mechanism

Cat.Nos	Description	MRP* ₹ / Unit	Pack
---------	-------------	------------------	------

Switches 6A - 230V AC

6811 00	6A - Switch - SP - 1 Way - 1 Module	54	20/400
6811 11	6A - Switch - SP - 2 Way - 1 Module	122	20/200
6811 02	6A - Switch - SP - 1 Way - with Indicator - 1 Module	108	20/200
6811 03	6A - Switch - SP - 1 Way - with "Light" Marking - 1 Module	110	20/200
6811 04	6A - Switch - SP - 1 Way - with "Fan" Marking - 1 Module	110	20/200

Switches - 10A - 230V AC

6811 74	10A - Switch - 1 Way - 1 Module	58	20/200
6811 75	10A - Switch - 2 Way - 1 Module	124	20/200
6811 76	10A - Switch - 1 Way - with Indicator - 1 Module	108	20/200

Switches - 16A - 230V AC

6811 01	16A - Switch - SP - 1 Way - 1 Module	146	20/200
6811 12	16A - Switch - SP - 2 Way - 1 Module	212	20/200
6811 05	16A - Switch - SP - 1 Way - with Indicator - 1 Module	190	20/200

Switches - 20A - 230V AC

6811 07	20A - Switch - SP - 1 Way - 1 Module	174	20/200
6811 08	20A - Switch - SP - 1 Way - with Indicator - 1 Module	230	20/200
6811 13	20A - Switch - SP - 1 Way - with Indicator - 2 Module	262	10/100
6811 15	20A - Switch - DP - 1 Way - with Indicator - 2 Module	268	10/100

Switches - 25A - 230V AC

6811 06	25A - Switch - SP - 1 Way - with Indicator - 1 Module	244	20/200
---------	---	-----	--------

Switches - 32A - 230V AC

6811 16	32A - Switch - DP - 1 Way - with Indicator - 2 Module	356	10/100
---------	---	-----	--------

Push Button - 6A - 230V AC

6811 09	6A - Bell Push - SP - 1 Way - 1 Module	120	20/200
6811 10	6A - Bell Push - SP - 1 Way - with Indicator - 1 Module	146	20/200
6811 14	6A - Bell Push - SP - 1 Way - with Indicator - 2 Module	222	10/100

Accessory for Switch with Indicator

6811 37	LED Indicator for Switch (Red)	50	1/5/50
---------	--------------------------------	----	--------

Indian Standard Sockets

6811 24	6A - Socket - with Shutter - 3 Pin - ISI - 2 Module	188	20/200
6811 22	6/16A - Socket - with Shutter - ISI - 2 Module	270	10/100

* MRP - Maximum Retail Price Inclusive of all taxes including GST.
 ^Compatible with Atomberg (Efficio), Havells (Efficiencia neo), Orient (Aerostorm) as per 2023 fan models.

White - Mechanism

Cat.Nos	Description	MRP* ₹ / Unit	Pack
---------	-------------	------------------	------

Dimmers & Fan Regulators

6811 43	Rotary Dimmer - 400 Watts - 1 Module	578	5/50
6811 44	Rotary Dimmer - 500 Watts - 2 Module	752	10/100
6811 40	Fan Regulator - 4 Step - 100 Watts - ISI - 1 Module	570	5/50
6811 41	Fan Regulator - 100 Watts - with 360° Rotation - ISI - 2 Module	658	10/100
6811 42	Fan Regulator - 8 Step - 100 Watts - ISI - 2 Module	718	1/10/100
6811 99	Fan Regulator - BLDC - 2 Module^	670	1/10/100

Skirting Light

6811 50	Skirting Light - 2 Module	470	10/50
---------	---------------------------	-----	-------

Indicator

6811 38	Flat Indicator Red - 1 Module	190	20/200
---------	-------------------------------	-----	--------

Bell Call Indicator

6811 46	Bell Call Indicator - 1 Module	816	20/200
---------	--------------------------------	-----	--------

Buzzer

6811 39	Buzzer - 230V - 1 Module	364	20/200
---------	--------------------------	-----	--------

Remote Unit

6811 54	Remote Control Unit - for Light & Fan - 4 Module	5126	1/5/20
---------	--	------	--------

Hospitality Function
Hotel Keycard Switch

6811 17	32A - DP - Key Tag Switch (Mechanical) - 2 Module	594	1/10
6811 79	Keytag for (681117) WH	276	10/100
6811 47	15A - Key Card Switch with Key Fob - Monoblock	2864	1/10

Hotel "DND and MMR" Functions

6811 48	Internal DND & MMR Control Unit - 2 Module	370	10/100
6811 49	External DND & MMR Control Unit - with Bell Push - 2 Module	436	10/100

Shaver Socket

6811 55	Shaver Socket - 120V/230V - with Plate - 4 Module	5384	1/5/20
---------	---	------	--------

Tv Sockets

6811 33	TV Co - axial Socket - 1 Module	134	20/200
---------	---------------------------------	-----	--------

Data & Voice

6811 30	Telephone Socket - RJ11 - with Shutter - 1 Module	140	20/200
6811 31	Telephone Socket - Double RJ11 - with Shutter - 1 Module	212	20/200
6811 32	Information Socket - RJ45 - Cat 6 - UTP - with Shutter - 1 Module	729	20/200

Audio Video Connectors

6811 34	Preterminated HDMI Socket - 1 Module	1380	1/10
6811 35	Preterminated Audio/Video Connector - 1 Module	1376	1/10
6811 36	Preterminated Projector Connector - 1 Module	1791	1/10

Sound (Electronic Bell)

6811 45	Electronic Bell - 2 Module	408	10/100
---------	----------------------------	-----	--------

Protectors and Accessories
Motor Starter

6811 66	16A - Motor Starter - 2 Module	666	1/10/100
6811 67	25A - Motor Starter - 2 Module	666	1/10/100

Bold Cat.Nos are products normally available with Legrand (India) Stockists. Cat.Nos that are not bold - delivery within 4 - 8 weeks from the date of order. Bold packing quantity is our mandatory packing. Orders to be placed by Legrand (India) Stockist in multiples of the same.

Allzy™
White - Mechanism

Cat.Nos	Description	MRP* ₹ / Unit	Pack
---------	-------------	------------------	------

Modular MCB (IS : 608981:2002)

6811 56	6A - Modular MCB - SP - 1 Module	502	1/10/100
6811 57	10A - Modular MCB - SP - 1 Module	502	1/10/100
6811 58	16A - Modular MCB - SP - 1 Module	502	1/10/100
6811 59	20A - Modular MCB - SP - 1 Module	502	1/10/100
6811 60	25A - Modular MCB - SP - 1 Module	502	1/10/100
6811 61	32A - Modular MCB - SP - 1 Module	502	1/10/100
6811 62	16A - Modular MCB - DP - 2 Module	954	1/10/100
6811 63	20A - Modular MCB - DP - 2 Module	954	1/10/100
6811 64	25A - Modular MCB - DP - 2 Module	954	1/10/100
6811 65	32A - Modular MCB - DP - 2 Module	954	1/10/100

Power Unit

6811 27	Power Unit with 20A SP MCB & 16A Plug - 3 Module	1484	1/10
6811 28	Power Unit with 25A SP MCB & 16A Plug - 3 Module	1588	1/10

Electronic Function
USB Chargers (IS13252 (Part 1) / IEC 60950-1)

6811 52	USB Charger - 1500mA - Type A - 1 Module	1116	10/100
6811 51	USB Charger - 3000mA - Type A+ A - 2 Module	1782	10/100
6811 70	USB Charger - 3000mA - Type A + C - 2 Module	2164	10/100
6811 80	USB Charger - 3000mA/15 Watts - Type A - 1 Module	1740	1/5/50
6811 81	USB Charger - 3000mA/15 Watts - Type A + A - 1 Module	1918	1/5/50
6811 82	USB Charger - 3000mA/15 Watts - Type A + C - 1 Module	2446	1/5/50
6811 83	USB Charger - 3000mA/15 Watts - Type C + C - 1 Module	2670	1/5/50
6811 84	USB Charger - Power Delivery - 20 Watts - Type C - 1 Module	3244	1/5/50
6811 85	USB Charger - Power Delivery - 30 Watts - Type C + C - 2 Module	6158	1/3/30
6811 86	USB Charger - Power Delivery - 45 Watts - Type C - 2 Module	7756	1/3/30
NEW! 6811 96	USB Charger - Power Delivery - 65 Watts - Type C + C - 3 Module	9824	1/5/20

Accessories

6811 68	Cable Outlet - 8MM - 1 Module	112	20/200
6811 69	Blanking Plate - 1 Module	34	40/400

Matt Black Mechanism
Switches 6A - 230 V AC

6812 00	6A - Switch - SP - 1 Way - 1 Module	58	20/400
6812 11	6A - Switch - SP - 2 Way - 1 Module	138	20/200
6812 02	6A - Switch - SP - 1 Way - with Indicator - 1 Module	118	20/200
6812 03	6A - Switch - SP - 1 Way - with "Light" Marking - 1 Module	124	20/200
6812 04	6A - Switch - SP - 1 Way - with "Fan" Marking - 1 Module	124	20/200

Allzy™
Matt Black - Mechanism

Cat.Nos	Description	MRP* ₹ / Unit	Pack
---------	-------------	------------------	------

Switches 16A - 230 V AC

6812 01	16A - Switch - SP - 1 Way - 1 Module	166	20/200
6812 12	16A - Switch - SP - 2 Way - 1 Module	242	20/200
6812 05	16A - Switch - SP - 1 Way - with Indicator - 1 Module	220	20/200

Switches 20A - 230V AC

6812 07	20A - Switch - SP - 1 Way - 1 Module	204	20/200
6812 08	20A - Switch - SP - 1 Way - with Indicator - 1 Module	268	20/200
6812 13	20A - Switch - SP - 1 Way - with Indicator - 2 Module	300	10/100
6812 15	20A - Switch - DP - 1 Way - with Indicator - 2 Module	300	10/100

Switches 25A - 230 V AC

6812 06	25A - Switch - SP - 1 Way - with Indicator - 1 Module	276	20/200
---------	---	-----	--------

Switches 32A - 230 V AC

6812 16	32A - Switch - DP - 1 Way - with Indicator - 2 Module	410	10/100
---------	---	-----	--------

Push Button 6A - 230 V AC

6812 09	6A - Bell Push - SP - 1 Way - 1 Module	136	20/200
6812 10	6A - Bell Push - SP - 1 Way - with Indicator - 1 Module	166	20/200
6812 14	6A - Bell Push - SP - 1 Way - with Indicator - 2 Module	256	10/100

Indian Standard Sockets

6812 24	6A - Socket - with Shutter - 3 Pin - ISI - 2 Module	226	20/200
6812 22	6/16A - Socket - with Shutter - ISI - 2 Module	306	10/100

Dimmers & Fan Regulators

6812 43	Rotary Dimmer - 400 Watts - 1 Module	662	5/50
6812 44	Rotary Dimmer - 500 Watts - 2 Module	858	10/100
6812 40	Fan Regulator - 4 Step - 100 Watts - ISI - 1 Module	660	5/50
6812 41	Fan Regulator - 100 Watts - with 360° Rotation - ISI - 2 Module	750	10/100
6812 42	Fan Regulator - 8 Step - 100 Watts - ISI - 2 Module	848	1/10/100
6812 99	Fan Regulator - BLDC - 2 Module^	764	10/100

Skirting Light

6812 50	Skirting Light - 2 Module	536	1/10/50
---------	---------------------------	-----	---------

Indicator

6812 38	Flat Indicator Red - 1 Module	210	20/200
---------	-------------------------------	-----	--------

Buzzer

6812 39	Buzzer - 230V - 1 Module	414	20/200
---------	--------------------------	-----	--------

Remote Unit

6812 54	Remote Control Unit - for Light & Fan - 4 Module	5440	1/5/20
---------	--	------	--------

Hospitality Function
Hotel Keycard Switch

6812 17	32A - DP - Key Tag Switch (Mechanical) - 2 Module	676	1/10
6812 79	Keytag for (681217) MB	310	10/100
6812 47	15A - Key Card Switch with Key Fob - Monoblock	3598	1/10

Hotel "DND and MMR" Functions

6812 48	Internal DND & MMR Control Unit - 2 Module	456	10/100
6812 49	External DND & CMR Control Unit - with Bell Push - 2 Module	516	10/100

* MRP - Maximum Retail Price Inclusive of all taxes including GST.

^Compatible with Atomberg (Efficio), Havells (Efficiencia neo), Orient (Aerostorm) as per 2023 fan models.

Red Cat.Nos - new products

Bold Cat.Nos are products normally available with Legrand (India) Stockists. Cat.Nos that are not bold - delivery within 4 - 8 weeks from the date of order. Bold packing quantity is our mandatory packing. Orders to be placed by Legrand (India) Stockist in multiples of the same.

Allzy™ Matt Black - Mechanism

Cat.Nos	Description	MRP* ₹ / Unit	Pack
---------	-------------	------------------	------

Shaver Socket

6812 55	Shaver Socket - 120V/230V - with Plate - 4 Module	6140	1/5/20
---------	---	------	--------

Tv Sockets

6812 33	TV Co - axial Socket - 1 Module	154	20/200
---------	---------------------------------	-----	--------

Data & Voice

6812 30	Telephone Socket - RJ11 - with Shutter - 1 Module	166	20/200
6812 31	Telephone Socket - Double RJ11 - with Shutter - 1 Module	236	20/200
6812 32	Information Socket - RJ45 - Cat 6 - UTP - with Shutter - 1 Module	857	20/200

Audio Video Connectors

6812 34	Preterminated HDMI Socket - 1 Module	1571	1/10
6812 35	Preterminated Audio/Video Connector - 1 Module	1570	1/10
6812 36	Preterminated Projector Connector - 1 Module	2040	1/10

Protectors & Accessories

Motor Starter

6812 66	16A - Motor Starter - 2 Module	766	1/10/100
6812 67	25A - Motor Starter - 2 Module	766	1/10/100

Modular MCB (IS : 608981:2002)

6812 56	6A - Modular MCB - SP - 1 Module	572	1/10/100
6812 57	10A - Modular MCB - SP - 1 Module	572	1/10/100
6812 58	16A - Modular MCB - SP - 1 Module	572	1/10/100
6812 59	20A - Modular MCB - SP - 1 Module	572	1/10/100
6812 60	25A - Modular MCB - SP - 1 Module	572	1/10/100
6812 61	32A - Modular MCB - SP - 1 Module	572	1/10/100

Power Unit

6812 27	Power Unit with 20A SP MCB & 16A Plug - 3 Module	1688	1/10
6812 28	Power Unit with 25A SP MCB & 16A Plug - 3 Module	1812	1/10

Electronic Function

USB Chargers (IS13252 (Part 1) / IEC 60950-1)

6812 52	USB Charger - 1500mA - Type A - 1 Module	1402	10/100
6812 51	USB Charger - 3000mA - Type A + A - 2 Module	2072	10/100
6812 70	USB Charger - 3000mA - Type A + C - 2 Module	2470	10/100
6812 80	USB Charger - 3000mA/15 Watts - Type A - 1 Module	1918	1/5/50
6812 81	USB Charger - 3000mA/15 Watts - Type A + A - 1 Module	2124	1/5/50
6812 82	USB Charger - 3000mA/15 Watts - Type A + C - 1 Module	2644	1/5/50
6812 83	USB Charger - 3000mA/15 Watts - Type C + C - 1 Module	2892	1/5/50
6812 84	USB Charger - Power Delivery - 20 Watts - Type C - 1 Module	3656	1/5/50
6812 85	USB Charger - Power Delivery - 30 Watts - Type C + C - 2 Module	6630	1/3/30
6812 86	USB Charger - Power Delivery - 45 Watts - Type C - 2 Module	8552	1/3/30
NEW! 6812 96	USB Charger - Power Delivery - 65 Watts - Type C + C - 3 Module	10474	1/5/20

* MRP - Maximum Retail Price Inclusive of all taxes including GST.
Red Cat. Nos - New Products

Allzy™ Matt Black - Mechanism

Cat.Nos	Description	MRP* ₹ / Unit	Pack
---------	-------------	------------------	------

Accessories

6812 68	Cable Outlet - 8MM - 1 Module	128	20/200
6812 69	Blanking Plate - 1 Module	40	40/400

Cover Plates with Support Frame White Cover Plates with Support Frame

6813 00	Cover Plate + Frame - 1 Module - White	144	20/200
6813 01	Cover Plate + Frame - 2 Module - White	144	20/200
6813 02	Cover Plate + Frame - 3 Module - White	204	10/100
6813 03	Cover Plate + Frame - 4 Module - White	216	10/100
6813 04	Cover Plate + Frame - 6 Module - White	296	5/50
6813 05	Cover Plate + Frame - 8 Module - Horizontal-White	362	5/50
6813 06	Cover Plate + Frame - 2*4 Module - Vertical-White	362	5/25
6813 07	Cover Plate + Frame - 9 Module - White	420	5/50
6813 08	Cover Plate + Frame - 12 Module - White	520	10
6813 09	Cover Plate + Frame - 16 Module - White	556	10
6813 10	Cover Plate + Frame - 18 Module - White	594	10

Matt Black Cover Plates With Support Frame

6813 11	Cover Plate with Frame - 1 Module - Matt Black	184	20/200
6813 12	Cover Plate with Frame - 2 Module - Matt Black	184	20/200
6813 13	Cover Plate with Frame - 3 Module - Matt Black	242	10/100
6813 14	Cover Plate with Frame - 4 Module - Matt Black	278	10/100
6813 15	Cover Plate with Frame - 6 Module - Matt Black	378	5/50
6813 16	Cover Plate with Frame - 8 Module - Horizontal-Matt Black	416	5/50
6813 17	Cover Plate with Frame - 2*4 Module - Vertical-Matt Black	416	5/25
6813 18	Cover Plate with Frame - 9 Module - Matt Black	502	5/50
6813 19	Cover Plate with Frame - 12 Module - Matt Black	606	10
6813 20	Cover Plate with Frame - 16 Module - Matt Black	690	10
6813 21	Cover Plate with Frame - 18 Module - Matt Black	734	10

Gold Cover Plates with Support Frame

6813 33	Cover Plate with Frame - 1 Module - Gold	194	20/200
6813 34	Cover Plate with Frame - 2 Module - Gold	194	20/200
6813 35	Cover Plate with Frame - 3 Module - Gold	262	10/100
6813 36	Cover Plate with Frame - 4 Module - Gold	284	10/100
6813 37	Cover Plate with Frame - 6 Module - Gold	420	5/50
6813 38	Cover Plate with Frame - 8 Module - Horizontal-Gold	468	5/50
6813 39	Cover Plate with Frame - 2*4 Module - Vertical-Gold	468	5/25
6813 40	Cover Plate with Frame - 9 Module - Gold	562	5/50
6813 41	Cover Plate with Frame - 12 Module - Gold	676	10
6813 42	Cover Plate with Frame - 16 Module - Gold	734	10
6813 43	Cover Plate with Frame - 18 Module - Gold	778	10

Bold Cat.Nos are products normally available with Legrand (India) Stockists. Cat.Nos that are not bold - delivery within 4 - 8 weeks from the date of order. Bold packing quantity is our mandatory packing. Orders to be placed by Legrand (India) Stockist in multiples of the same.

Allzy™
Cover Plates

Cat.Nos	Description	MRP* ₹ / Unit	Pack
---------	-------------	------------------	------

Aluminium Champagne Cover Plates with Support Frame

6813 44	Cover Plate with Frame - 1 Module - Aluminium Champagne	194	20/200
6813 45	Cover Plate with Frame - 2 Module - Aluminium Champagne	194	20/200
6813 46	Cover Plate with Frame - 3 Module - Aluminium Champagne	262	10/100
6813 47	Cover Plate with Frame - 4 Module - Aluminium Champagne	284	10/100
6813 48	Cover Plate with Frame - 6 Module - Aluminium Champagne	420	5/50
6813 49	Cover Plate with Frame - 8 Module - Horizontal- Aluminium Champagne	468	5/50
6813 50	Cover Plate with Frame - 2*4 Module - Vertical- Aluminium Champagne	468	5/25
6813 51	Cover Plate with Frame - 9 Module - Aluminium Champagne	562	5/50
6813 52	Cover Plate with Frame - 12 Module - Aluminium Champagne	676	10
6813 53	Cover Plate with Frame - 16 Module - Aluminium Champagne	734	10
6813 54	Cover Plate with Frame - 18 Module - Aluminium Champagne	778	10

Rose Gold Cover Plates with Support Frame

6813 55	Cover Plate with Frame - 1 Module - Rose Gold	194	20/200
6813 56	Cover Plate with Frame - 2 Module - Rose Gold	194	20/200
6813 57	Cover Plate with Frame - 3 Module - Rose Gold	262	10/100
6813 58	Cover Plate with Frame - 4 Module - Rose Gold	284	10/100
6813 59	Cover Plate with Frame - 6 Module - Rose Gold	420	5/50
6813 60	Cover Plate with Frame - 8 Module - Horizontal-Rose Gold	468	5/50
6813 61	Cover Plate with Frame - 2*4 Module - Vertical-Rose Gold	468	5/25
6813 62	Cover Plate with Frame - 9 Module - Rose Gold	562	5/50
6813 63	Cover Plate with Frame - 12 Module - Rose Gold	676	10
6813 64	Cover Plate with Frame - 16 Module - Rose Gold	734	10
6813 65	Cover Plate with Frame - 18 Module - Rose Gold	778	10

* MRP - Maximum Retail Price Inclusive of all taxes including GST.

Allzy™
Mounting Boxes

Cat.Nos	Description	MRP* ₹ / Unit	Pack
---------	-------------	------------------	------

Accessories
Metal Flush Boxes

6890 60	Metal Flush Box - 1 & 2 Module	88	40
6890 61	Metal Flush Box - 3 Module	116	40
6890 62	Metal Flush Box - 4 Module	140	40
6890 63	Metal Flush Box - 6 Module	222	40
6890 65	Metal Flush Box - 8 Module	278	40
6890 64	Metal Flush Box - 8 (2 Rows*4) Module	278	20
6890 66	Metal Flush Box - 12 (2 Rows*6) Module	386	10
6890 67	Metal Flush Box - 16 (2 Rows*8) Module	436	10
6890 68	Metal Flush Box - 18 Module	498	10

Plastic Surface Boxes

6890 70	Plastic Surface Box - 1 & 2 Module	70	50
6890 71	Plastic Surface Box - 3 Module	86	35
6890 72	Plastic Surface Box - 4 Module	112	25
6890 73	Plastic Surface Box - 6 Module	168	10
6813 70	Plastic Surface Box - 8 Module	254	10
6890 74	Plastic Surface Box - 8 (2 Rows*4) Module	230	10
6890 76	Plastic Surface Box - 12 (2 Rows*6) Module	280	10
6890 77	Plastic Surface Box - 16 (2 Rows*8) Module	330	10

Metal Surface Box

6890 78	Metal Surface Box - 18 Module	350	10
---------	-------------------------------	-----	----

Our switches are compliant with revised BIS standard (IS 3854:2023 requirements). Also, our switches are covered additionally for use on Self-Ballasted Lamp (SBL) loads.

SBL power rating as per IS3854:2023

Switch Rating	6A, 230V~	10A, 230V~	16A, 230V~	20A, 230V~
SBL power (Watt)	100 W	100 W	200 W	250 W

Bold Cat.Nos are products normally available with Legrand (India) Stockists. Cat.Nos that are not bold - delivery within 4 - 8 weeks from the date of order. Bold packing quantity is our mandatory packing. Orders to be placed by Legrand (India) Stockist in multiples of the same.

Britzy™ SWITCHES

Stylish Everyday Switches



Britzy™ is a switch range designed for everyday convenience. With reliable mechanisms and practical modules for power and connectivity, it offers a solution for contemporary homes and workplaces.

Features

- Complete switch range from 6A-32A tested & validated as per IS norms
- Range of shuttered sockets with 6A & 6/16A ratings for everyday usage
- Electronics range with fan regulators, dimmers & USB charging
- Connectivity solutions with data sockets & Hospitality range catering to a wide range of customers

Benefits

- Supports all load requirements—from light-duty to heavy-duty (16A-32A for ACs, geysers, appliances)
- Reliable performance for routine household and office needs
- Covers essential electrical controls in one range—fan speed, lighting intensity, and device charging
- Suitable for residential, commercial, and hospitality applications

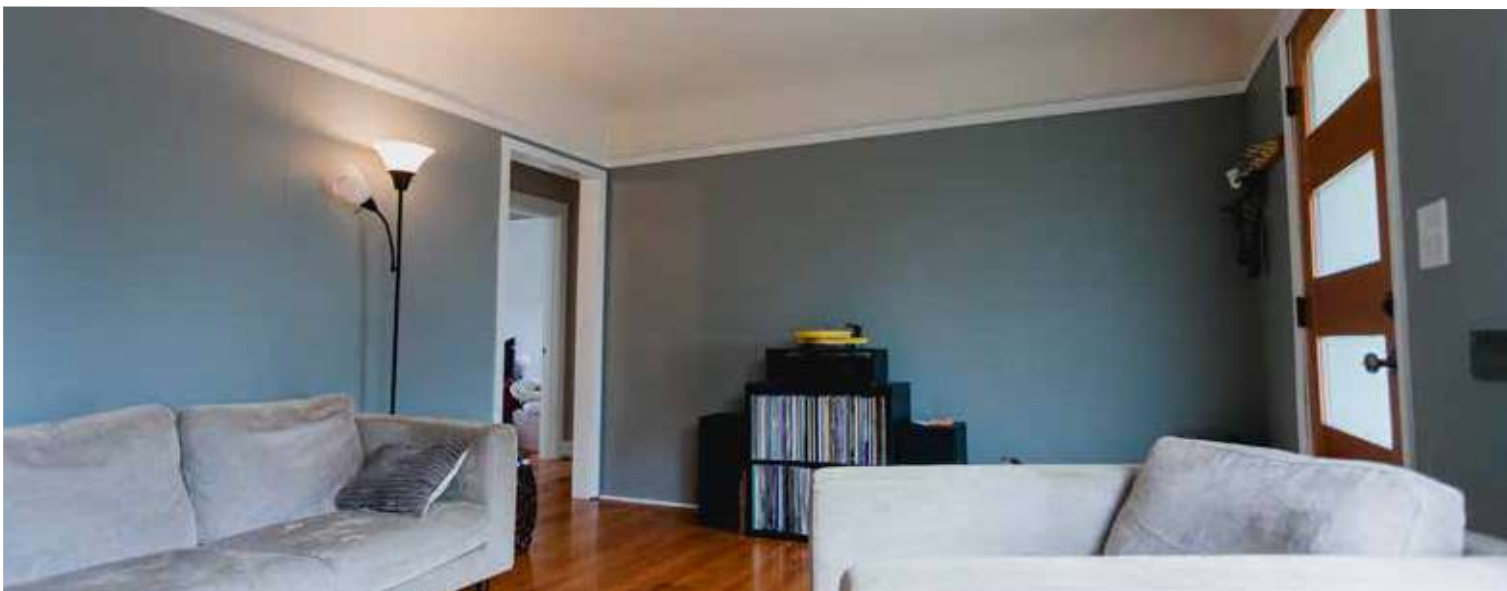

Range



Switch 6 A, 16 A



Switch 6 A two-way



Switch with indicator
6 A, 16 A, 25 A



Bell push with
indicator - 1 module



DP Switch 20 A, 32 A



Bell push with
indicator - 2 module



DND internal unit



DND external unit



6/16 A socket



Dimmer



Fan regulator
1 module



Fan regulator
2 module



USB charger
1 module



RJ 45



RJ 11 Telephone socket



Double RJ 11
Telephone socket



Bell call indicator



TV socket



Skirting light



Buzzer



Key card Switch 15 A



Flat indicator red

Scan to know more about
the product.



Britzy™

White Mechanism

Cat.Nos	Description	MRP* ₹ / Unit	Pack
---------	-------------	---------------------	------

Switches – 6A - 230V AC

6734 01	6A - Switch - SP - 1 Way - 1 Module	54	20/400
6734 02	6A - Switch - SP - 2 Way - 1 Module	128	20/200
6734 03	6A - Switch - SP - 1 Way - with Indicator - 1 Module	128	20/200

Switches – 16A - 230V AC

6734 11	16A - Switch - SP - 1 Way - 1 Module	184	20/200
6734 12	16A - Switch - SP - 2 Way - 1 Module	222	20/200
6734 13	16A - Switch - SP - 1 Way - with Indicator - 1 Module	198	20/200

Switches – 20A - 230V AC

6734 25	20A - Switch - DP - 1 Way - with Indicator - 2 Module	284	10/100
---------	---	-----	--------

Switches – 25A - 230V AC

6734 24	25A - Switch - SP - 1 Way - with Indicator - 1 Module	252	20/200
---------	---	-----	--------

Switches – 32A - 230V AC

6734 26	32A - Switch - DP - 1 Way - with Indicator - 2 Module	370	10/100
---------	---	-----	--------

Push Buttons

6734 04	6A - Bell Push - with Indicator - 1 Module	154	20/200
6734 06	6A - Bell Push - with Indicator - 2 Module	232	10/100

Indian Standard Sockets

6734 27	6A - Socket - with Shutter - 3 Pin - ISI - 2 Module	160	20/200
6734 55	6/16A - Socket - with Shutter - 3 Pin - 2 Module	278	10/100

Data & Voice

6734 41	Telephone Socket - RJ11 - 1 Module	146	20/200
6734 44	Telephone Socket - Double RJ11 - 1 Module	212	20/200
6734 45	Information Socket - RJ45 - Cat 6-UTP with shutter - 1 Module	340	20/200

* MRP - Maximum Retail Price Inclusive of all taxes including GST.

Britzy™

White Mechanism

Cat.Nos	Description	MRP* ₹ / Unit	Pack
---------	-------------	---------------------	------

Television Socket

6734 46	TV Co - axial Socket - 1 Module	134	20/200
---------	---------------------------------	-----	--------

Buzzer

6734 40	Buzzer - 230V - 1 Module	392	20/200
---------	--------------------------	-----	--------

Dimmers & Fan Regulators

6734 33	Light Dimmer - 400 Watts - 1 Module	620	5/50
6734 31	Fan Regulator - 100 Watts - ISI - 1 Module	604	5/50
6734 30	Fan Regulator - 100 Watts - ISI - 2 Module	770	10/100
6734 38	Fan Regulator - 8 Step - 100 Watts - ISI - 2 Module	694	10/100

Bell Call Indicator

6734 07	Bell Call Indicator - 1 Module	840	20/200
---------	--------------------------------	-----	--------

Motor Starter

6734 66	25A - Motor Starter - 2 Module	710	10/100
---------	--------------------------------	-----	--------

Modular MCB (IS : 60898-1:2002)

6734 64	16A - Modular MCB - SP - 1 Module	486	1/10/100
6734 61	20A - Modular MCB - SP - 1 Module	486	1/10/100
6734 36	25A - Modular MCB - SP - 1 Module	486	1/10/100
6734 37	32A - Modular MCB - SP - 1 Module	486	1/10/100

USB Charger

6731 35	USB Charger - 1500mA - Type A - 1 Module	1254	10/100
---------	--	------	--------

Skirting Light

6734 77	Skirting Light - 2 Module	602	5/50
---------	---------------------------	-----	------

Indicator

6734 75	Flat Indicator Red - 1 Module	154	20/200
---------	-------------------------------	-----	--------

Bold Cat.Nos are products normally available with Legrand (India) Stockists. Cat.Nos that are not bold - delivery within 4 - 8 weeks from the date of order. Bold packing quantity is our mandatory packing. Orders to be placed by Legrand (India) Stockist in multiples of the same.

Britzy™

White Mechanism

Cat.Nos	Description	MRP* ₹ / Unit	Pack
---------	-------------	------------------	------

Hospitality Function

Hotel Keycard Switch

6734 80	15A - Key Card Switch - 2 Module	3018	1/10
6734 83	Key Fob for Key Card Switch	220	1/10/100



6734 80

Hotel "DND and MMR" Functions

6734 81	Internal DND & MMR Control Unit - 2 Module	340	1/10/100
6734 82	External DND & MMR Control Unit - with Bell Push - 2 Module	398	1/10/100



6734 82

Accessories

6734 71	Cable Outlet - 1 Module	116	20/200
6734 90	Blanking Plate - 1 Module	38	40/400
6734 72	Blanking Plate - 2 Module	52	10/100

Cover Plates with Support Frame

White Cover Plates with Support Frame

6734 91	Cover Plate + Support Frame - 1 Module - White	122	20/200
6734 92	Cover Plate + Support Frame - 2 Module - White	122	20/200
6734 93	Cover Plate + Support Frame - 3 Module - White	168	10/100
6734 94	Cover Plate + Support Frame - 4 Module - White	176	10/100
6734 96	Cover Plate + Support Frame - 6 Module - White	236	5/50
6734 98	Cover Plate + Support Frame - 8 Module - Horizontal - White	302	5/50
6734 95	Cover Plate + Support Frame - 2*4 Module - Vertical - White	302	5/25
6734 97	Cover Plate + Support Frame - 12 Module - White	438	10
6734 99	Cover Plate + Support Frame - 16 Module - White	470	10
6735 00	Cover Plate + Support Frame - 18 Module - White	578	10



6734 91



6734 92



6734 93



6734 96

Britzy™

Plates with Frame

Cat.Nos	Description	MRP* ₹ / Unit	Pack
---------	-------------	------------------	------

Accessories

Metal Flush Boxes

6890 60	Metal Flush Box - 1 & 2 Module	88	40
6890 61	Metal Flush Box - 3 Module	116	40
6890 62	Metal Flush Box - 4 Module	140	40
6890 63	Metal Flush Box - 6 Module	222	40
6890 65	Metal Flush Box - 8 Module	278	40
6890 64	Metal Flush Box - 8 (2 Rows*4) Module	278	20
6890 66	Metal Flush Box - 12 (2 Rows*6) Module	386	10
6890 67	Metal Flush Box - 16 (2 Rows*8) Module	436	10
6890 68	Metal Flush Box - 18 Module	498	10



6890 60



6890 61



6890 63

Plastic Surface Boxes

6890 70	Plastic Surface Box - 1 & 2 Module	70	50
6890 71	Plastic Surface Box - 3 Module	86	35
6890 72	Plastic Surface Box - 4 Module	112	25
6890 73	Plastic Surface Box - 6 Module	168	10
6890 75	Plastic Surface Box - 8 Module	230	10
6890 74	Plastic Surface Box - 8 (2 Rows*4) Module	230	10
6890 76	Plastic Surface Box - 12 (2 Rows*6) Module	280	10
6890 77	Plastic Surface Box - 16 (2 Rows*8) Module	330	10

Metal Surface Box

6890 78	Metal Surface Box-18 Module	350	10
---------	-----------------------------	-----	----

* MRP - Maximum Retail Price Inclusive of all taxes including GST.

Bold Cat.Nos are products normally available with Legrand (India) Stockists. Cat.Nos that are not bold - delivery within 4 - 8 weeks from the date of order. Bold packing quantity is our mandatory packing. Orders to be placed by Legrand (India) Stockist in multiples of the same.

Britzy™ SWITCHES

THE NO PROBLEM SWITCH



Guarantee

- The Company, at its discretion, will replace products if they have any manufacturing defect within 10 years for switches (without LED lamp) and power sockets. For all other Britzy™ wiring accessories the guarantee will be 2 years.
- The above guarantee is applicable when the devices are used in Legrand metal flush boxes. Otherwise the guarantee period will be reduced by 50%.
- The guarantee is only applicable when the products are installed as per the Company's instructions and not tampered in any manner.
- The guarantee states the Company's entire liability. It does not extend to cover consequential loss or damage or installation costs arising from defective products.

Our switches are compliant with revised BIS standard (IS 3854:2023) requirements. Also, our switches are covered additionally for use on Self-Ballasted Lamp (SBL) loads.

SBL power rating as per IS3854:2023

Switch Rating	6A, 230V~	10A, 230V~	16A, 230V~	20A, 230V~
SBL power (Watt)	100 W	100 W	200 W	250 W

10A SWITCHES

Switch Type: 10A 1Way



Myrius

Mylinc

Lyncus

Allzy

Switch Type: 10A 1Way With Indicator



Myrius

Mylinc

Lyncus

Allzy

Switch Type: 10A 2Way



Myrius

Mylinc

Lyncus

Allzy

Colour: White

RANGES: Myrius™ | Mylinc™ | Lyncus™ | Allzy™



USB CHARGING SOLUTIONS

Available with Fast Charging & Industry First Laptop Charging Solutions



MOBILE CHARGING SOLUTIONS



USB Type: A Type
Rating: 15W-3A - 1M



USB Type: A+A Type
Rating: 15W-3A - 1M



USB Type: A+C Type
Rating: 15W-3A - 1M



USB Type: C+C Type
Rating: 15W-3A - 1M



USB Type: C Type
Rating: 20W-PD - 1M

RANGES: **LIVING now** | **ARTEOR™ ADVANCE** FEEL SOMETHING NEW | ARTEOR™ | Myrius™ | Lyncus™ | Allzy™

MOBILE AND LAPTOP CHARGING SOLUTIONS

Compatible for Laptop Charging



USB Type: C+C Type
Rating: 30W-PD - 2M



USB Type: C Type
Rating: 45W-PD - 2M



USB Type: C+C Type
Rating: 65W-PD - 3M

RANGES: **LIVING now** | **ARTEOR™ ADVANCE** FEEL SOMETHING NEW | ARTEOR™ | Myrius™ | Lyncus™ | Mylinc | Allzy™

RANGES: **ARTEOR™ ADVANCE** FEEL SOMETHING NEW | ARTEOR™ | Myrius™ | Lyncus™ | Allzy™



BLDC FAN

Regulator

Control for Energy-Efficient Fans

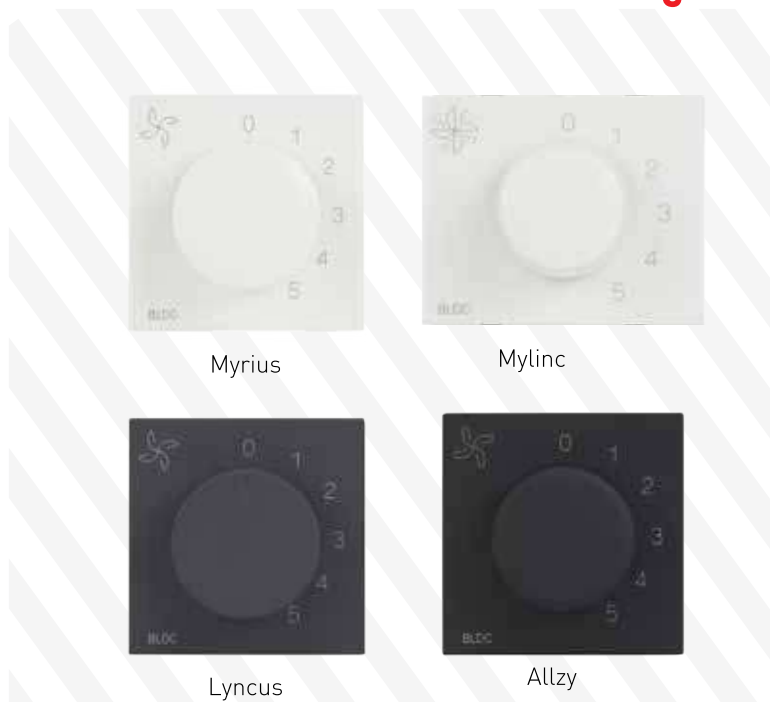

BLDC Fan Regulator enables smooth and efficient speed regulation for BLDC ceiling fans (non-remote), helping optimise comfort and power usage in modern homes. Designed to integrate seamlessly with modular wiring devices, it combines precise control with refined aesthetics.

Features

- Exclusive compatibility with BLDC ceiling fans (non-remote)
- Advanced speed control mechanism for smooth adjustment
- Modular design compatible with Myrius, Mylinc, Lyncus & Allzy switch plates

Benefits

- Maximizes energy efficiency compared to traditional regulators
- Improves comfort with effortless and precise fan speed control
- Enhances interior aesthetics with coordinated modular styling
- Ensures reliable everyday performance in residential spaces

Available in white and color mechanism finishes

RANGES: Myrius™ | Mylinc™ | Lyncus™ | Allzy

*Please note that only the following models are supported: Atomberg (Efficio), Havells (Efficiencia neo), and Orient (Aerostorm) as of the 2023 models.

*Suitable for Fans with declaration from manufacturers for application of Step fan regulator



LIVING NOW KNX

KEYPADS

Intelligent Room Controls

Living Now KNX keypads provide an intuitive interface for smart building environments, enabling effortless room-level control through the KNX bus. Designed to complement modern interiors, the range offers multiple mechanism colours and plate finishes for seamless architectural integration.

Features

- 4/6-channel KNX keypads for customizable scene and device control
- Dedicated controls for lighting, blinds, HVAC, and sockets within KNX systems
- Mechanism color options in white, sand and black with a wide plate finish selection
- Compatible with KNX automation ecosystems, including touch controllers

Benefits

- Simplifies smart building interaction with intuitive fingertip controls
- Enhances occupant comfort through precise management of lighting, climate, and shading
- Supports energy efficiency with centralized automation via KNX systems
- Maintains design harmony with customizable finishes suited for contemporary interiors



LIVING NOW KNX Keypads: Smart Control at your Fingertips

Available in 4 and 6 channel controls, our KNX keypads are available in 3 mechanism colors and 16 plate finishes. Manage lighting, shutters, sockets, and HVAC effortlessly.



WHITE



SAND



BLACK



LIVING NOW IoT

Redefining Smart Living

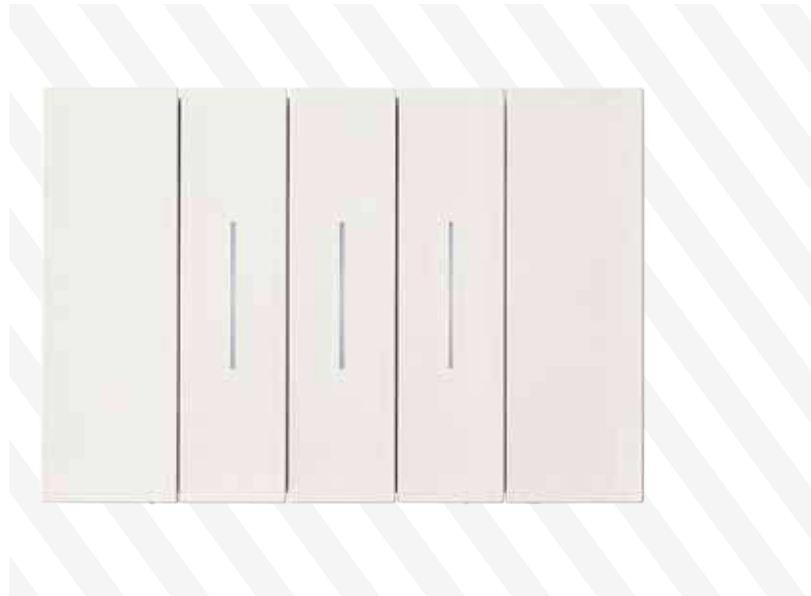

Living Now IoT is a connected home solution that enables intuitive control of lighting, power, and automation through wireless technology. Combining elegant touch interfaces with smartphone and voice control, it brings seamless smart living to modern homes without complex rewiring.

Features

- Multi-platform control through touch panels, smartphone apps, and voice assistants
- Wireless smart scenes enabling instant control of lighting and connected appliances
- Seamless compatibility with Apple HomeKit, Google Home, and Amazon Alexa ecosystems

Benefits

- Simplifies Smart Upgrades with wireless installation and minimal infrastructure changes
- Enhances Everyday Convenience through unified control from mobile devices or voice commands
- Creates Personalized Living Experiences using automated lighting and appliance scenes

WIRELESS 4 SCENARIOS CONTROL

Works with



Control with

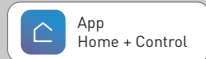

Touch control



Control with smartphone



Voice control



REDEFINING SMART LIVING



MIX OF INNOVATION AND SIMPLICITY, READY TO BE DISCOVERED.



TOUCH CONTROL



CONTROL WITH
SMARTPHONE



VOICE CONTROL



Living Now, has won this prestigious international award confirming Legrand's ability to combine technology and design.



Workstation Power and Data Solutions

Flexible Power and Data Access for Modern Workspaces

Legrand Workstation Solutions provide a complete and integrated approach to power and data distribution for modern office environments. Combining floor boxes, raised and screed floor systems, pop-up desk units, and perimeter trunking, the range is designed to deliver seamless connectivity, organized cable management, and flexible workstation layouts. Engineered for both performance and aesthetics, these solutions ensure easy installation, scalability, and adaptability to evolving workspace needs—making them ideal for dynamic offices, commercial spaces, and collaborative environments.

Features

- Comprehensive solution for power, AV & data distribution
- Compatible with perimeter, desk, raised access floors and screed floor systems
- Designed for fast installation with high reliability, robustness, and flexibility
- Engineered for strength, supporting superior load capacities for demanding environments

Benefits

- Ensures organized and efficient power and data distribution across office spaces
- Enables flexible workstation layouts with easily accessible floor and desk outlets
- Improves workspace aesthetics with concealed and flush-mounted installations
- Supports scalable infrastructure for high-density workstation environments and future expansion

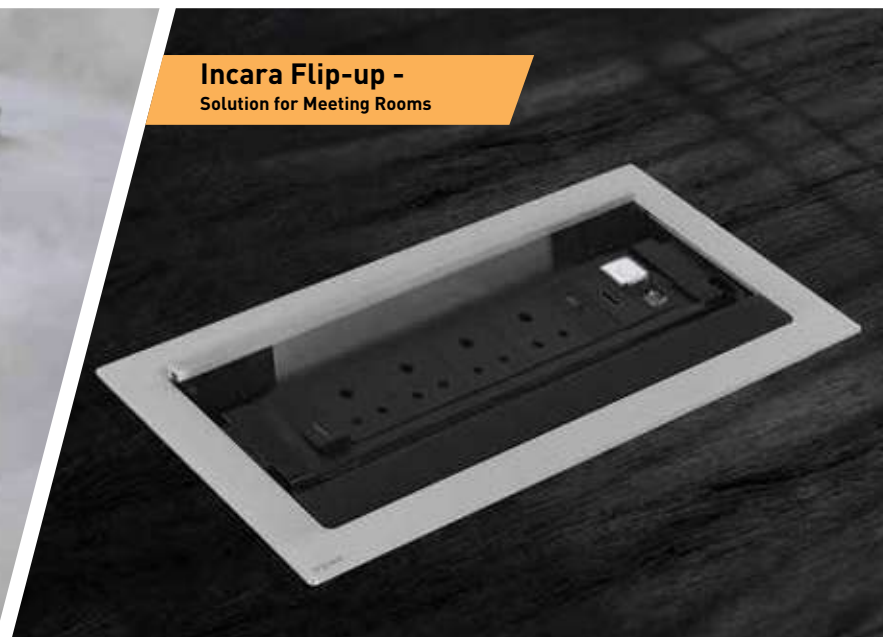

Alongside the Incara™ range, Legrand provides additional workspace solutions such as trunking systems, raised floor boxes, metal and aluminium floor outlets, desk grommets, and underfloor distribution to support scalable office infrastructure.



Soluflex cable floor system



Raceways : PVC & Metal (GI)



Floor boxes

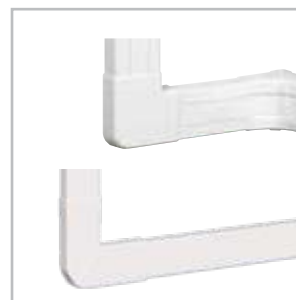

Dlp trunking system:
Snap-on, Mini & PVC, Aluminium



Cablofil wire mesh cable trays

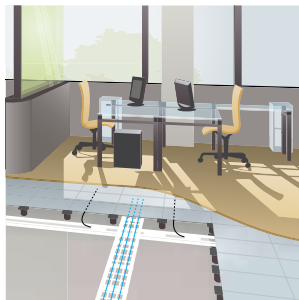

Raised access floor systems



Screed floor system



Wall and ceiling systems

Scan to know more about the product.



Incara Top Access



Disq 80



Disq 60

INCARA™ Pop-up Box

Elegant Design with Seamless Connectivity



Incara™ Pop-up provides convenient access to power, data, and charging for laptops, smartphones, tablets, and AV equipment directly at the workspace. Its patented design integrates discreetly into furniture, offering smooth damper operation and premium finishes that blend seamlessly with modern interiors.

Features

- Extra-slim pop-up design compatible with 15–40 mm desktops
- Multiple module configurations available in 3, 4, 8, and 2x4 formats. Also available 4 module in IP44 option
- Premium finishes including White, Black, Aluminium, and Brushed Aluminium
- Compatible with 250+ Arteor & Advance modules, including USB-C PD up to 63/65W

Benefits

- Improves workspace efficiency with easy access to power and connectivity
- Maintains a clean desk aesthetic with discreet, flush integration into furniture
- Ensures reliable daily use with robust construction and protection options
- Adapts to evolving technology needs through modular configuration and fast charging support

Now Available with
Arteor™ Advance Modules



Scan to know more about
the product.



INCARA™ Flip-up Box

Elegant Connectivity for Premium Meeting Rooms



Incara™ Flip-up is a premium tabletop connectivity solution designed for modern meeting rooms. Its fully metal construction and patented push-to-open mechanism allow the unit to rise smoothly while the cover slides discreetly inside even with devices plugged in providing seamless access to power, data, and AV connections.

Features

- Patented push-to-open flip mechanism with smooth, dual-sided access
- Robust all-metal construction with premium finish
- Quick, tool-free installation for 15–40 mm desktops
- Pre-equipped Arteor modules including sockets, USB-C charging, HDMI, and RJ45

Benefits

- Enhances meeting room aesthetics with discreet, integrated connectivity
- Improves collaboration through easy access to power and data from both sides
- Reduces installation time with fast and secure mounting design
- Supports modern AV setups with versatile power, data, and charging options



Now Available with
Arteor™ Advance Modules

Scan to know more about
the product.



INCARA™ Top Access

Discreet Cable Management for Meeting Tables



Incara™ Top Access provides a practical solution for organizing power modules and cables beneath meeting tables. With a flush-mounted lid and integrated storage basket, it keeps worktops clear while allowing easy access to chargers, power strips, and connectivity modules in modern meeting and collaboration spaces.

Features

- Integrated metal storage basket for power strips and excess cabling
- Two width options: 295 mm and 385 mm for different table sizes
- Premium finishes: White, Black, and Metal to match furniture styles
- Flush-mount lid with soft-close damper for 10–40 mm desktops

Benefits

- Keeps meeting tables organised by concealing cables and adapters
- Maintains a clean, professional workspace appearance
- Simplifies cable routing with dedicated under-desk storage
- Supports flexible integration with office power and connectivity modules



Scan to know more about the product.



Incara™ Flip up

Cat.Nos	Description	MRP* ₹ / Unit	Pack
---------	-------------	------------------	------

Max. power: 3680 W at 230 VA
 6A switch d IS 3854 : 1997
 6A sockets IS 1293: 2019
 USB IEC 60950 1
 IS 13252(Part 1)
 Protection IK 07 & IP 30
 For flush mounting in furniture,
 Compatible for desk thickness 15 to 40
Incara™ Flip up Pre Equipped (Arteor Advance)

6540 24	Flip-up 8M SW 2 SKT USB C+C 1 HDMI	37480	1
6540 25	Flip-up 8M SW 2 SKT USB C+C 1 RJ45 1 HDMI	38376	1
6540 26	Flip-up 12M SW 4 SKT USB C+C 1 HDMI	41476	1
6540 27	Flip-up 12M SW 4 SKT USB C+C 1 RJ45 1 HDMI	42338	1



6540 24

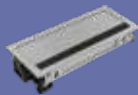

6540 27

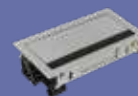

6540 22

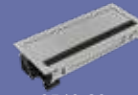

6540 23

INCARA Flip Up (Empty)

To be equipped version of the Incara Flip up is compatible with Arteor Advance accessories, which need to be purchased separately.

6540 22	Flip-up 8M To Be Equipped Version	32181	1
6540 23	Flip-up 12M To Be Equipped Version	34437	1

INCARA Top Access (Empty)

Easy storage for an office module, Desktop Power Center, Legrand UI with Surface Box DLP with accessories or equivalent product that can accommodate chargers and wires.

Resistance to impacts: IK 07
 Operating temperature: from 5°C to +35°C

For Flush Mounting In Furniture, Compatible Table Thickness 10 To 40

6548 70	Top Access 295MM Wide Aluminium	11033	1
6548 71	Top Access 295MM Wide White	12851	1
6548 72	Top Access 295MM Wide Black	12332	1
6548 73	Top Access 395MM Wide Aluminium	14667	1
6548 74	Top Access 395MM Wide White	16420	1
6548 75	Top Access 395MM Wide Black	15706	1



6548 70



6548 73



6548 75

INCARA Pop Up (Empty)

Cat.Nos	Description	MRP* ₹ / Unit	Pack
---------	-------------	------------------	------

Resistance to Impact: IK 07
 IP 44 for 6 548 12 & IP 20 for the others
 Operating temperature: from 5°C to +35°C
 Conform to standard BS 5733
 Compatible with Arteor accessories, which need to be purchased separately.
 Switch d IS 3854 : 1997
 Sockets IS 1293: 2019
 USB IEC 60950 1
 Switch lasts 100000 & Socket for 10000 plug ins
 Fire resistant up to 850°C for 30 seconds.

For Flush Mounting In Furniture, Compatible Desktop Thickness 15 to 40.

6548 45	Pop-up 3M Brushed Aluminium	4568	1
6548 46	Pop-up 3M White	3714	1
6548 47	Pop-up 3M Black	3714	1
6548 48	Pop-up 3M Aluminium	3714	1
6548 00	Pop-up 4M Brushed Aluminium	5740	1
6548 01	Pop-up 4M White	5219	1
6548 02	Pop-up 4M Black	5219	1
6548 03	Pop-up 4M Aluminium	5219	1
6548 12	IP 44 Pop-up 4M Brushed Aluminium	8944	1
6548 08	Pop-up 8M Brushed Aluminium	11673	1
6548 09	Pop-up 8M White	10613	1
6548 10	Pop-up 8M Black	10613	1
6548 11	Pop-up 8M Aluminium	10613	1
6548 04	Pop-up 2x4M Brushed Al	12257	1
6548 05	Pop-up 2x4M Wh	11143	1
6548 06	Pop-up 2x4M Black	11143	1
6548 07	Pop-up 2x4M Al	11143	1



6548 46



6548 48



6548 00



6548 01



6548 03



6548 10



6548 04

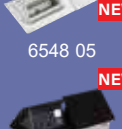

6548 05

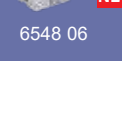

6548 06

* MRP - Maximum Retail Price Inclusive of all taxes including GST.
 Red Cat.Nos - new products

Bold Cat.Nos are products normally available with Legrand (India) Stockists.
 Cat.Nos that are not bold - delivery within 4 - 8 weeks from the date of order.
 Bold packing quantity is our mandatory packing. Orders to be placed by Legrand (India) Stockist in multiples of the same.

NEW!

Desktop Power Center

Practical Power for Modern Workspaces



Desktop Power Center (DPC) brings power and connectivity right to your fingertips. Designed for modern workspaces, it delivers seamless access to power, charging, AV, and data—while keeping desks clean, organized, and clutter-free. Fully customizable with power sockets, USB chargers, and connectivity modules, DPC adapts effortlessly to your workspace needs with style and efficiency

Features

- Modular 6M and 8M configurations with 3-pin 6A sockets and optional USB charging
- Flexible mounting options for on-desk, under-desk, or wall installation
- Child-safe IP20 sockets tested for up to 10,000 plug cycles
- IS-certified switch socket design with maximum load capacity up to 1440 W

Benefits

- Provides convenient power access directly at the workspace
- Keeps desks organised by reducing cable clutter
- Enhances user safety with child-protected outlets
- Simplifies installation with versatile mounting options

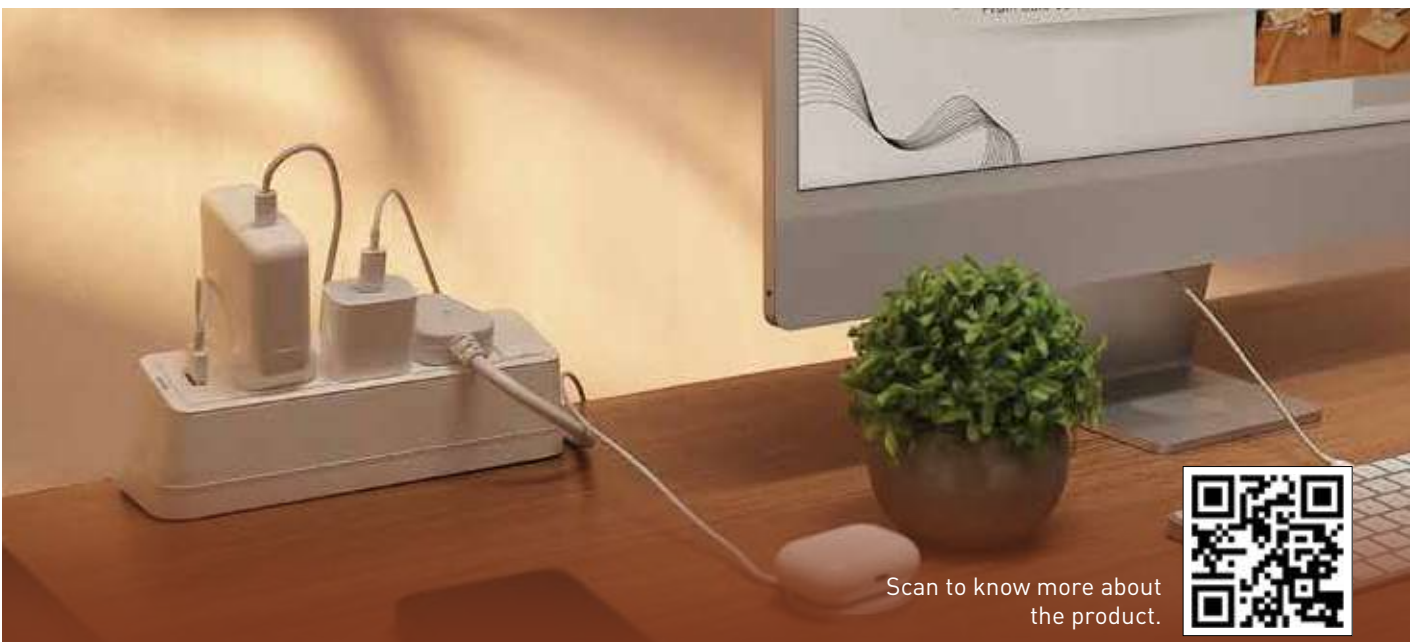

Scan to know more about the product.



Desktop Power Center

Cat.Nos	Description	MRP* ₹ / Unit	Pack
---------	-------------	------------------	------

Switch IS 3854 : 1997
Sockets IS 1293: 2019
USB IEC 60950 1
Switch lasts 100000 & Socket for 10000 plug ins
Fire resistant up to 850°C for 30 seconds.
Input : 100 240V 50 60Hz/250 mA
Output 5V 1500mA
Power rating 1440W Max
3 PIN Socket 6A 230V IP 20 Rated

Desktop Power Center supplied With L Bracket Kit

1.5 meter cord and a 3 pin plug for easy connection to power



6550 20



6550 22



6550 24



6550 21



6550 23



6550 25



6550 27

6550 20	6M DPC SKT White	1348	1
6550 22	8M DPC SKT White	1753	1
6550 24	6M DPC SKT ChicGrey	1660	1
6550 26	8M DPC SKT ChicGrey	2092	1

Desktop Power Center with USB Type A

6550 21	6M DPC SKT USB A White	2159	1
6550 23	8M DPC SKT USB A White	2966	1
6550 25	6M DPC SKT USB A ChicGrey	2495	1
6550 27	8M DPC SKT USB A ChicGrey	3412	1

Desktop Power Center with USB Type A + C Ports

6550 21AC	6M DPC SKT USB A+C White	3647	1
6550 23AC	8M DPC SKT USB A+C White	3861	1
6550 25AC	6M DPC SKT USB A+C ChicGrey	3740	1
6550 27AC	8M DPC SKT USB A+C ChicGrey	3981	1



6550 21AC



6550 23AC



6550 25AC



6550 27AC

Desktop Power Center

Cat.Nos	Description	MRP* ₹ / Unit	Pack
---------	-------------	------------------	------

Desktop Power Center (Empty)

To be equipped version of the DPC comes without the cord, installation kit, and accessories. It is compatible with Lyncus accessories, which need to be purchased separately.



6550 30



6550 31



6550 32



6550 33

6550 30	6M DPC (To Be Equipped) White	673	1
6550 31	6M DPC (To Be Equipped) ChicGrey	774	1
6550 32	8M DPC (To Be Equipped) White	878	1
6550 33	8M DPC (To Be Equipped) ChicGrey	1009	1

Desktop Power Center DPC Accessories

The accessories come with three installation kits, each containing a different bracket: the Angle L Bracket, Flat I Bracket, and Wall Mount T Bracket. The L Bracket is included with the product, while the I Bracket and T Bracket are available for purchase separately.



026988W



6550 36



6550 37



6550 38

0269 88W	Cord with 3 Pin (BIS) Wh 1.5Mtr	■	1
0269 88B	Cord with 3 Pin (BIS) Black 1.5Mtr	■	1
6550 36	DPC Angle L-Bracket	163	1
6550 37	DPC Flat I-Bracket	149	1
6550 38	DPC Wall T-Bracket	218	1

* MRP - Maximum Retail Price Inclusive of all taxes including GST.
■ Price available on request.

Bold Cat.Nos are products normally available with Legrand (India) Stockists. Cat.Nos that are not bold - delivery within 4 - 8 weeks from the date of order. Bold packing quantity is our mandatory packing. Orders to be placed by Legrand (India) Stockist in multiples of the same.

NEW!

DISQ 60 and DISQ 80

Compact Desk Power for Modern Workspaces



DISQ 60 & DISQ 80 bring smart, desk-integrated power, USB, and data right where you need it. Built for modern workspaces, they blend seamlessly into desks and meeting tables—delivering instant connectivity while keeping surfaces sleek, clean, and clutter-free.

Features

- Circular desk-mounted design for seamless integration into desks and meeting tables
- Integrated power and USB charging for laptops and everyday office devices
- Power sockets compliant with IS 1293 and USB compliant with IS 13252 standards
- Durable construction with IK07 impact resistance for reliable daily use

Benefits

- Provides convenient power and charging access directly at the workspace
- Maintains clean desk aesthetics with minimal visual footprint
- Reduces cable clutter and dependence on external chargers or power strips
- Supports efficient and organised workspaces in offices and meeting rooms



Scan to know more about the product.

Everything you need.
Right where you work



Disq 60

INCARA DISQ 60 delivers sleek, discreet access to power or USB charging with quick, hassle-free installation.

- Ultimate flexibility – mount horizontally or vertically on any surface, from desks to sofas and lockers, with a patented system that fits even ultra-thin panels (1 mm).



Disq 80

INCARA DISQ 80 combines power, data, and charging in one compact solution for modern, mobile users.

- Ideal for individual workstations, delivering seamless and efficient connectivity.
- Smart retrofit design – easily replaces existing cable outlets (80 mm Ø cut-out).
- Flexible configurations with 6 UTP sockets or cable outlets for quick, hassle-free access.

NEW! Disq 60 and Disq 80

Cat.Nos	Description	MRP* ₹ / Unit	Pack
---------	-------------	------------------	------

Supply voltage: 250V~
Frequency: 50/60 Hz
Sockets complies with IS 1293
USB complies with IS 13252
Resistance to impact: IK 07
Operating temperature: from -5°C to +35°C
Storage temperature: from -10°C to +70°C



6540 32

6540 32 DISQ 60 1 6A SKT WH 3530 1



6540 29

6540 29 DISQ 60 1 6A SKT BL 3530 1



6540 30

6540 30 DISQ 60 1 USB A+C WH 6270 1



6540 31

6540 31 DISQ 60 1 USB A+C BL 6270 1



6540 33

6540 33 DISQ 80 1 6A SKT USB C 15W CABLE OUTLET WH 6240 1



6540 36

6540 36 DISQ 80 1 6A SKT USB C 15W CABLE OUTLET BL 6240 1

6540 34 DISQ 80 1 6A SKT USB A+C 15W RJ45 CAT6 WH 6550 1



6540 37

6540 37 DISQ 80 1 6A SKT USB A+C 15W RJ45 CAT6 BL 6550 1



6540 39

6540 39 DISQ 80 1 6A SKT USB C 15W CABLE OUTLET BL-METAL 6730 1



6540 40

6540 40 DISQ 80 1 6A SKT USB C 15W RJ45 CAT6 BL-METAL 7070 1

* MRP - Maximum Retail Price Inclusive of all taxes including GST.
Red Cat.Nos - new products

Bold Cat.Nos are products normally available with Legrand (India) Stockists. Cat.Nos that are not bold - delivery within 4 - 8 weeks from the date of order. Bold packing quantity is our mandatory packing. Orders to be placed by Legrand (India) Stockist in multiples of the same.

POP-UP BOXES For Floor

Seamless Floor Design, Superior Protection



Pop-up Boxes for Floor provide discreet floor-mounted access to power, data, and AV connections in modern workspaces. With a slim profile, soft-opening mechanism, and durable construction, they integrate smoothly into floor systems while ensuring reliable connectivity for offices and collaborative environments.

Features

- Extra-slim floor box design with corrosion-resistant, halogen-free construction
- Soft-opening cover with damper and push-slide locking mechanism
- Modular configuration for power, audio, video, and data using Arteor modules
- Robust protection: IP40 rating and IK07 impact resistance for high-traffic areas

Benefits

- Maintains clean floor aesthetics with discreet connectivity access
- Reduces cable clutter by providing power and data at floor level
- Ensures durable performance in high-use commercial environments
- Enhances user convenience with smooth and secure opening operation



Scan to know more about
the product.



Pop Up Box

Cat.Nos	Description	MRP* ₹ / Unit	Pack
---------	-------------	------------------	------

Pop Up Flush Mounting Boxes For Floor To Be Equipped

Installation accessories should be considered additionally along with the pop up box.

For installation, use flush mounting boxes for concrete floors or kits for raised access floors.

To be equipped with Arteor accessories.

3 modules

0540 10	Pop-up 3M Aluminium	3795	1
0540 15	Pop-up 3M Brass	4963	1
0540 20	Pop-up 3M Stainless Steel	5015	1



0540 15



0540 20

4 Modules

0540 11	Pop-up 4M Aluminium	5094	1
0540 16	Pop-up 4M Brass	5872	1
0540 21	Pop-up 4M Stainless Steel	6357	1
0540 26	Pop-up 4M Matt Black	5650	1
0540 31	Pop-up 4M Glossy White	5783	1



0540 16



0540 21



0540 26



0540 31

6 (2 x 3) Modules

0540 12	Pop-up 6M Aluminium	8516	1
0540 17	Pop-up 6M Brass	10649	1
0540 22	Pop-up 6M Stainless Steel	11042	1



0540 12

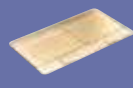

0540 17



0540 22

Pop Up Box

Cat.Nos	Description	MRP* ₹ / Unit	Pack
---------	-------------	------------------	------

8 (2 x 4) Modules

0540 13	Pop-up 8M Aluminium	10546	1
0540 18	Pop-up 8M Brass	12779	1
0540 23	Pop-up 8M Stainless Steel	13595	1
0540 28	Pop-up 8M Matt Black	12141	1
0540 33	Pop-up 8M Glossy White	12211	1



0540 18



0540 23

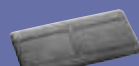

0540 28



0540 33

Installation Kits For Raised Access Floors

Include an empty receptacle and fixing brackets for raised access floor tiles Compatible with:

- Cat. 6 data cabling
- Audio/video cabling

0540 05	Installation Kit 3M Pop-up	1576	1
0540 06	Installation Kit 4M Pop-up	1892	1
0540 07	Installation Kit 6M Pop-up	2623	1
0540 08	Installation Kit 8M Pop-up	3238	1



0540 06

For Installation Of Pop-Up Floor Boxes In Concrete Floors

Equipped with knockouts for \varnothing 20 and \varnothing 25 mm conduits

Metal Flush-Mounting Boxes

0540 00	Back Box Concrete 3M Pop-up	408	1
0540 01	Back Box Concrete 4M Pop-up	540	1
0540 02	Back Box Concrete 6M Pop-up	863	1
0540 03	Back Box Concrete 8M Pop-up	1085	1



0540 00

* MRP - Maximum Retail Price Inclusive of all taxes including GST.

Bold Cat.Nos are products normally available with Legrand (India) Stockists. Cat.Nos that are not bold - delivery within 4 - 8 weeks from the date of order. Bold packing quantity is our mandatory packing. Orders to be placed by Legrand (India) Stockist in multiples of the same.

CABLOFIL®

Most Versatile Cable Tray System



Cablofil® provides wire mesh cable tray systems designed for efficient cable management in power, data, and telecom installations. Engineered from welded steel, the system enables fast installation, flexible routing, and reliable support for modern commercial and industrial infrastructures.

Features

- Wide tray ranges like CF30, CF54, CF105, CF150 in multiple widths and finishes
- Fast assembly system for quick, secure tray connections
- Flexible mounting for overhead, wall, and ceiling installations
- CEI 61537 compliant welded steel construction

Benefits

- Speeds up installation with modular components and simplified assembly
- Ensures safe cable routing with smooth wire mesh construction and reliable support
- Adapts easily to different project requirements
- Supports long-term durability and dependable performance

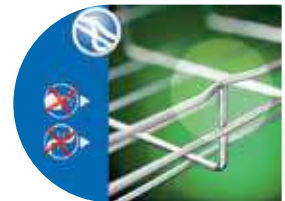

Scan to know more about the product.

*This is a design-and-build product. Design support can be provided as required. Pricing is available upon request and is not included in this price list.

NEW!

SALAMANDRE®

Secure IP4X Overhead Trunking



Salamandre® (MSTR series) is a steel distribution trunking system designed for organized cable routing in commercial and industrial environments. With durable construction and multiple size options, it supports structured power and data distribution while maintaining system reliability and installation efficiency.

Features

- IP4X-rated protection with TORX® security screws and cover straps at joints
- Up to 50% faster installation with pre-installed couplers and Avdel bushes
- Complete fittings range including bends, tees, crossovers, reducers, and end caps
- Multi-compartment steel trunking in sizes from 50×50 mm to 600×150 mm

Benefits

- Prevents unauthorised access with secure, tool-operated lid fixing
- Reduces installation time with pre-assembled components
- Optimises cable routing for power and data distribution systems
- Ensures durable and reliable cable protection

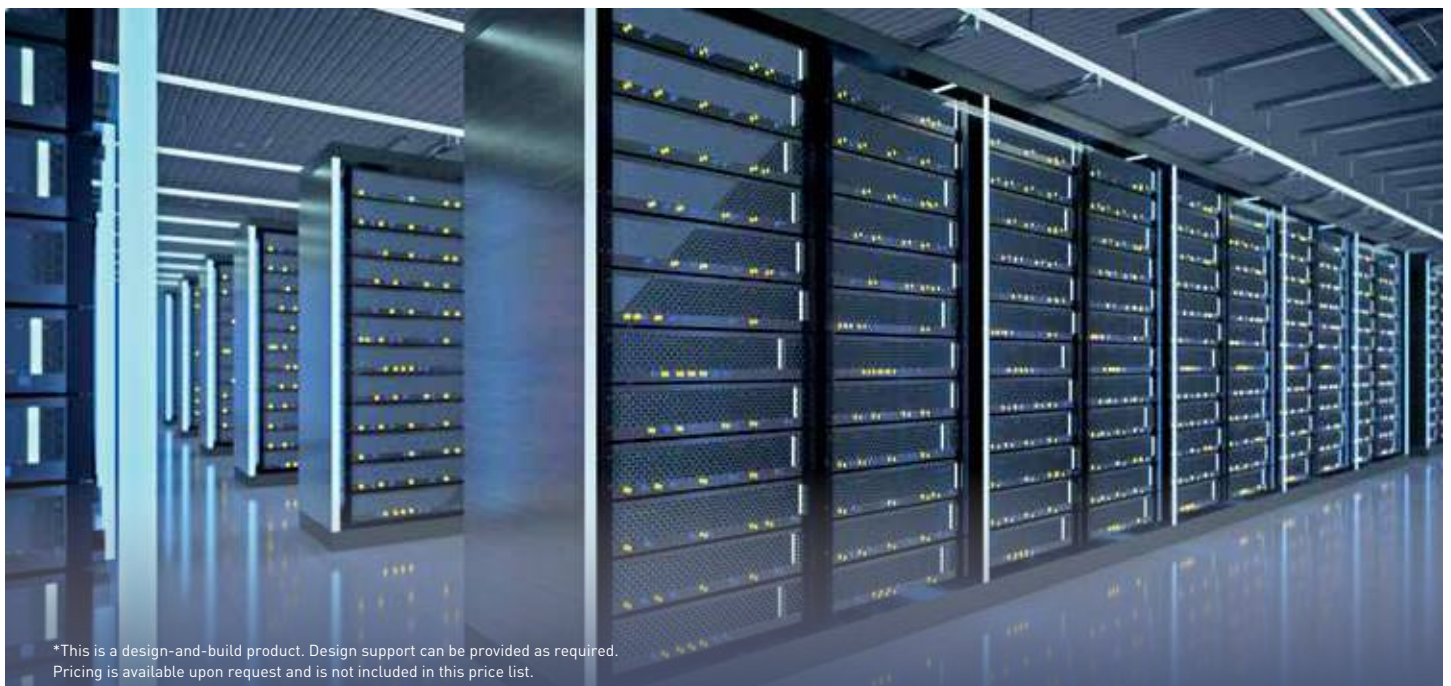

*This is a design-and-build product. Design support can be provided as required. Pricing is available upon request and is not included in this price list.

NEW!

FIBRE RACEWAY

Optimal Fiber Ducting

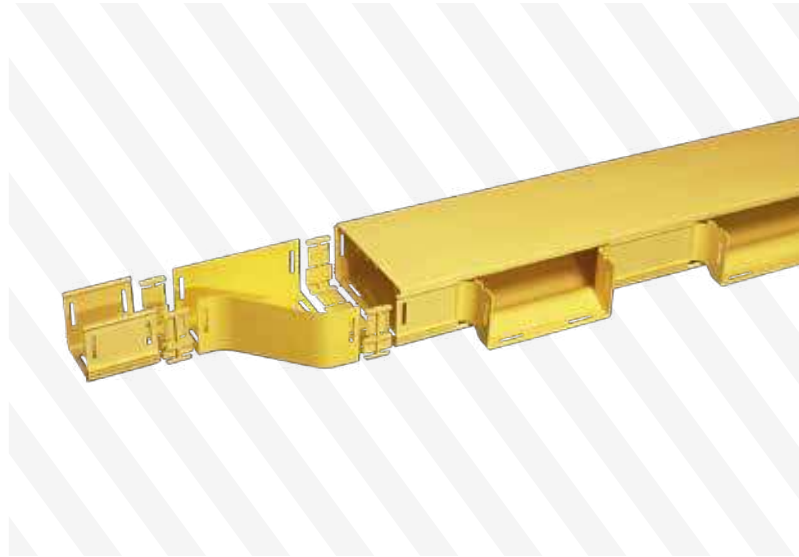

Fibre Raceway is a modular, high-visibility yellow LSZH ducting system designed for organized fibre routing in data centers and network environments. It supports scalable infrastructure while maintaining clear, structured cable pathways.

Features

- Modular 2 m ducts with snap-fit couplers and routing fittings
- Integrated drop-offs with trumpet outlets and \varnothing 38/50 mm tubing
- Flexible mounting via suspension kits, ladder rack brackets, and cabinet kits
- Certified design (UL94-V0/V1, RoHS, UL2024A) supporting up to 7200 fibre cords

Benefits

- Enables quick network expansion without disturbing existing fibre
- Speeds installation with modular snap-fit components
- Maintains organized routing for reliable fibre management
- Improves safety with LSZH, self-extinguishing recyclable material

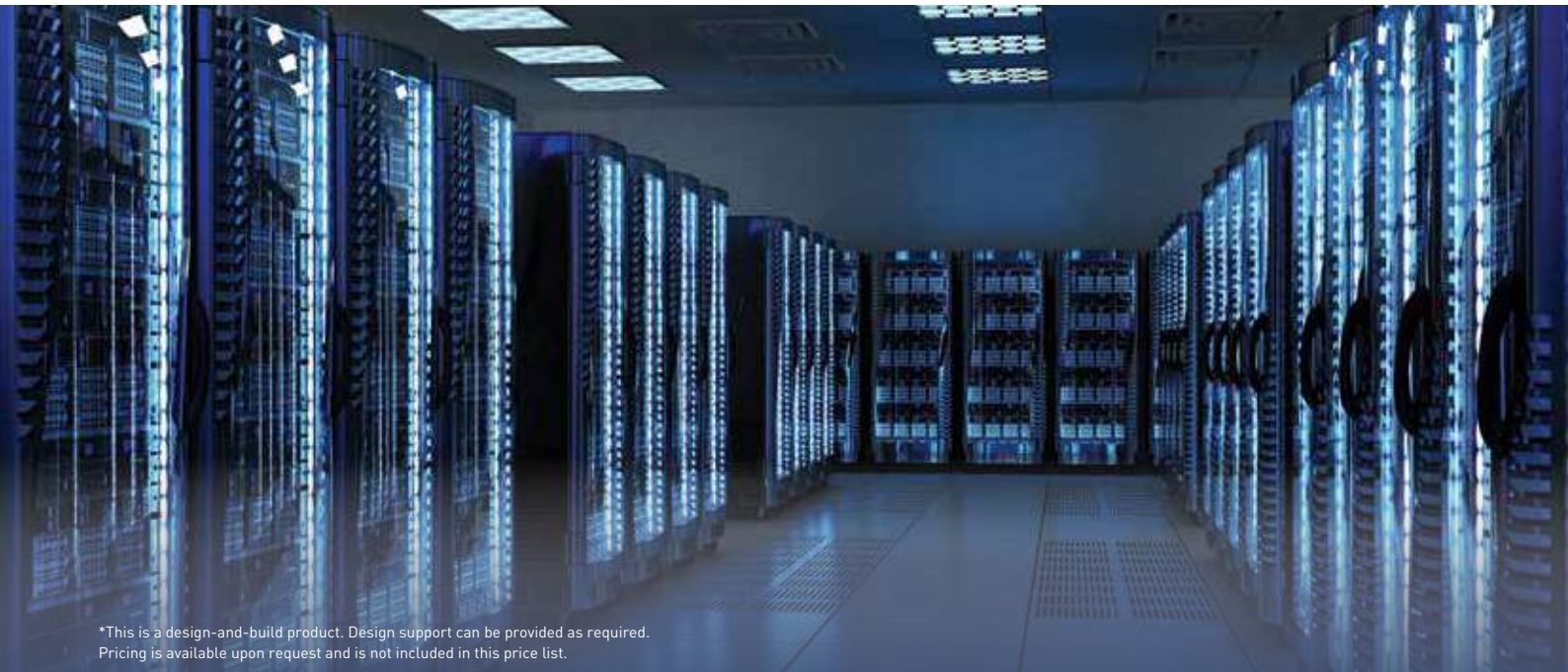

*This is a design-and-build product. Design support can be provided as required. Pricing is available upon request and is not included in this price list.

Floor Solution

Cat.Nos	Description	MRP* ₹ / Unit	Pack
---------	-------------	------------------	------

Over Floor Trunking

Conform to Std EN 50085-2-2; For creating a link between trunking, column, mini-column, floor units or protecting cables on passageways Supplied with cover

0300 92	Floor Duct 50X12	773	54 ⁽¹⁾
0300 11	Flat Angle/Floor 50X12	345	10
0300 12	Cover Gasket To Floor 50X12	435	10
0300 93	Floor Duct 75X18	1053	36 ⁽¹⁾
0300 18	Flat Angle/Floor 75X18	665	10
0300 19	Cover Gasket/Floor 50X12	461	10
0328 00	Floor Duct 92X20	2201	20 ⁽¹⁾
0328 07	End Cap For Floor Duct 92x20	384	10
0328 03	Cover Joint For Floor Duct 92x20	525	10
0328 02	Flat Angle For Floor Duct 92x20	960	5

Confirms to EN 50 085 - 2 - 2
Raceways are made from PVC and Galvanised sheet. Compatible with Cat.6 structured cabling system.

Raceways - PVC

**Raceways - PVC - Height 38 MM;
Standard Length 2 Meters*; Price Per Meter**

0896 67	PVC Raceway 50X38	1661	12
0896 68	PVC Raceway 100X38 2-CMT	3051	16
0896 69	PVC Raceway 150X38 3-CMT	4678	10

Raceways - Metal / Gi

**Raceways - Metal/GI - Height 25 mm; Length 2.44 m.
Price Per Unit (One Unit Is Of 2.44 Meters)**

6895 10	Trunking 50x25	2923	3/54 ⁽¹⁾
6895 11	Trunking 75x25	3764	3/21 ⁽¹⁾
6895 12	Trunking 100x25	4570	3/54 ⁽¹⁾
6895 13	Trunking 150x25	6171	3/18 ⁽¹⁾
6895 14	Trunking 225x25 3-CMT	9677	3/12 ⁽¹⁾
6895 15	Trunking 300x25 3-CMT	12264	3/18 ⁽¹⁾

**Raceways - Metal/GI - Height 38 mm; Length 2.44 m
Price Per Unit (One Unit Is Of 2.44 meters)**

6895 00	Trunking 50x38	3394	3/54 ⁽¹⁾
6895 01	Trunking 75x38	4369	3/21 ⁽¹⁾
6895 02	Trunking 100x38	5421	3/54 ⁽¹⁾
6895 03	Trunking 150x38	7269	3/36 ⁽¹⁾
6895 04	Trunking 225x38 3-CMT	10741	3/12 ⁽¹⁾
6895 05	Trunking 300x38 3-CMT	13474	3/18 ⁽¹⁾

* MRP - Maximum Retail Price Inclusive of all taxes including GST.

Floor Solution

Cat.Nos	Description	MRP* ₹ / Unit	Pack
---------	-------------	------------------	------

Floor Raceway Accessories

**Fixing Brackets 2 Nos For Each Openable
Raceway Length**

6897 09	Fixing Bracket 50X25	92	9
6897 10	Fixing Bracket 75X25	102	9
6897 12	Fixing Bracket 100X25	104	9
6897 15	Fixing Bracket 150X25	108	9
6897 20	Fixing Bracket 225X25	151	9
6897 30	Fixing Bracket 300X25	204	9

Fixing Bracket

6897 27	Fixing Bracket 50X38	102	9
6897 28	Fixing Bracket 75X38	108	9
6897 37	Fixing Bracket 100X38	113	9
6897 38	Fixing Bracket 150X38	128	9
6897 25	Fixing Bracket 225X38	193	9
6897 35	Fixing Bracket 300X38	236	9

Riser

6897 23	Vertical Riser For 225	3300	1
6897 33	Vertical Riser For 300	3795	1

Coupler For Joining Raceways

6897 77	Coupling 38	204	6
6897 79	Coupling 25	182	6

Junction Box

For direct access to cables at the intersection of raceways
Supplied completely with base and cover plate (Lid)

Height Adjustable Junction Box 65 - 90 mm

6896 10	JB150X150X65-90	3580	1
6896 11	JB 225X225X65-90	4429	1
6896 12	JB 300X300X65-90	5697	1
6896 13	JB 400X400X65-90	8836	1

Height Adjustable Junction Box 65 - 90 mm With Fly Over

For direct access to cables at the intersection of floor raceways while maintaining perfect separation and 900 cross overs between data and power cables

6896 14	JB FLY 225X225X65-90	4783	1
6896 15	JB FLY 300X300X65-90	6515	1
6896 16	JB FLY 400X400X65-90	9546	1

Height Adjustable Junction Box 50 - 70 mm

6896 83	JB 150 X 150 X 50	3257	1
6896 84	JB 225 X 225 X 50	3999	1
6896 85	JB 300 X 300 X 50	5203	1
6896 86	JB 400 X 400 X 50	7988	1

Bold Cat.Nos are products normally available with Legrand (India) Stockists. Cat.Nos that are not bold - delivery within 4 - 8 weeks from the date of order. Bold packing quantity is our mandatory packing. Orders to be placed by Legrand (India) Stockist in multiples of the same.

Floor Solution

Cat.Nos	Description	MRP* ₹ / Unit	Pack
Optional Site Cove for Junction Box			
6896 18	Cover JB 150X150X65-90	398	10
6896 19	Cover JB 225X225X65-90	559	10
6896 20	Cover JB 300X300X65-90	860	10
6896 21	Cover JB 400X400X65-90	1290	10

Selection Chart

Back Box	+	Lid & Trim	+	Support Plate
Floor Box for Raised Floor				
6896 38	+	689631	+	689662/ 689617/ 689678
Floor Box for screed Floor (3 Compartment)				
6896 34	+	689631	+	689662/ 689617/ 689678
Floor Box for screed Floor (4 Compartment)				
6896 45	+	689641	+	89662/ 689617/ 689678
Floor box for Tiles/Marble				
0896 04	+	689652/689655/689656	+	689662/ 689617/ 689678
50 Reduced Height Floor Box				
0880 73	+	088070	+	689662/ 689617/ 689678

Regular Floor Boxes Range

Floor Boxes for Raised & Screed Floor (3-CMP)

6896 38	RF Backbox for 3-CPM (For Carpet)	6141	1
6896 34	SF Backbox For 3-CPM (For Carpet)	9612	1
6896 31	265X265 Lid & Trim Carpet 8MM 3-CPM	4684	5

Regular Floor Boxes for Screed Floor (4-CMP)

6896 45	Backbox for 4-CPM	10541	1
6896 41	Lid & Trim 4-CPM	5067	1

Floor Solution

Cat.Nos	Description	MRP* ₹ / Unit	Pack
---------	-------------	------------------	------

Stainless Steel Insert for Lid

For a metal finish on lid
To be used instead of fitting carpet onto the Lid

6896 92	SS Insert For Lid	5700	1
---------	-------------------	------	---

Floor Boxes for Tile / Marble

0896 04	Backbox (For Tile)	7917	1
6896 52	Floor Box Tile 15 To 22MM	39710	1
6896 55	Lid/Trim Grey Painted Headband Tile 8 To 15MM	10891	5
6896 56	Lid/Trim SS Headband Tile 8 To 15MM	12520	5

Reduced Height Vertical Floor Box - 50mm

0880 73	Back Box (Use With 088070)	11683	1
0880 70	Lid & Trim 50 To 70 MM	11537	1
0880 72	SS Insert PL For 50MM FB	7351	5

Support Plates for Regular Floor Boxes

77 mm with plate

689662L	Blank Plate	497	12
6896 17	Support Plate Myrius 8M	532	1
6896 78	Support Plate Waved	1538	5

NEW! Heavy Duty Floor Boxes IP40

0880 80	Boite encast réglable 55-125	19284	1
0880 86	4 screws for height extension feets	3750	1
0880 88	Foam block for height extension	8200	1
0896 82	Heavy load support 15KN	65750	1
0896 85	Access trap for junction	54752	1
0896 86	Floor box with direct central exit	116549	1
0896 87	Cable exit accessory - IP52	62273	1

Bold Cat.Nos are products normally available with Legrand (India) Stockists. Cat.Nos that are not bold - delivery within 4 - 8 weeks from the date of order. Bold packing quantity is our mandatory packing. Orders to be placed by Legrand (India) Stockist in multiples of the same.

* MRP - Maximum Retail Price Inclusive of all taxes including GST. For regular floor boxes height adjustment is 65-90mm without accessories and 77-90mm with accessories. Red Cat.Nos - new products

Floor Solution

Cat.Nos	Description	MRP* ₹ / Unit	Pack
---------	-------------	------------------	------

NEW! New Floor Boxes

Plastic Grey Lid and Trim

0807 09	Frame & Lid Plastic Screed 12 M Hz	6150	1
0807 10	Frame & Lid Plastic Screed 18 M Hz	6680	1
0807 11	Frame & Lid Plastic Screed 24 M Hz	7970	1
0807 12	Frame & Lid Plastic Screed 8 M Vt	7760	1
0807 13	Frame & Lid Plastic Screed 12 M Vt	9540	1
0807 14	Frame & Lid Plastic Screed 16 M Vt	11340	1



NEW! Metal SS Finish Lid and Trim

0807 27	Frame & Lid Metal Screed 12 M Hz	26520	1
0807 28	Frame & Lid Metal Screed 18 M Hz	27430	1
0807 29	Frame & Lid Metal Screed 24 M Hz	28930	1
0807 30	Frame & Lid Metal Screed 8 M Vt	28180	1
0807 31	Frame & Lid Metal Screed 12 M Vt	30400	1
0807 32	Frame & Lid Metal Screed 16 M Vt	32410	1



NEW! Flush Metal SS Finish Lid & Trim

0807 45	Flush Concrete Floor 12 Modules Hz	29450	1
0807 46	Flush Concrete Floor 18 Modules Hz	35420	1
0807 47	Flush Concrete Floor 24 Modules Hz	36560	1
0807 48	Flush Concrete Floor 8 Modules Vt	31000	1
0807 49	Flush Concrete Floor 12 Modules Vt	38390	1
0807 50	Flush Concrete Floor 16 Modules Vt	39900	1



Universal Adjustable Backbox

0880 80	Universal Back Box 55-125MM	19284	1
----------------	-----------------------------	-------	---



Floor Solution

Cat.Nos	Description	MRP* ₹ / Unit	Pack
---------	-------------	------------------	------

Mounting Adaptors For Screed Floor

0880 81	Adaptation Plate for 8/12M	4173	1
0880 82	Adaptation Plate for 12/18M	4512	1
0880 83	Adaptation Plate for 16/24M	4830	1



Auto-Adjusting Backbox

0880 90	Back Box 8/12M 65-90MM	5772	1
0880 91	Back Box 12/18M 65-90MM	6998	1
0880 92	Back Box 16/24M 65-90MM	8213	1



NEW! Reno Back Box

0881 90	Reno Back Box for Std Fb 8/12m	4650	1
0881 91	Reno Backbox for Std Fb 12/18m	5160	1
0881 92	Reno Backbox for Std Fb 16/24m	5070	1



Finish Plates

088015	SS Plate Grey Lid 8/12M	5667	1
088016	SS Plate Grey Lid 12/18M	5802	1
088017	SS Plate Grey Lid 16/24M	7872	1
088045	SS Plate Metal Lid 8/12M	8426	1
088046	SS Plate Metal Lid 12/18M	9670	1
088047	SS Plate Metal Lid 16/24M	10994	1



Floor Boxes 3 Module

Conform to EN 50 085 2.2 and EN 60670 23

IP 20/IK07

Compression test, 500N / 1cm² during 1 min :

Comply with norm CEI 60670 23 (2004)

089644	Floor Box 3M	2499	1
089649	Flush Mounting Box 3M	1663	1



IP66 Floor Box

IP66 Floor box complies with the IEC 60670 1 and IEC 60670 23 standards.

Resistance to loads: with the cover closed: 10000 N

Resistance to impacts: IK 09 with the cover closed

Self extinguishing : + 650° C / 30 s for parts made of insulating materials.









088061	IP66/IK09 Screwed SS Floor Box	27291	1
088064	IP66/IK09 Hinged CVR SS Floor Box	32052	1
088069	Back Box IP66 Floor, Min Screed Height 65	5237	1
088062	IP55 Cable Exit Accessory	30401	1
089307	Floor Access Unit Circular	11683	1

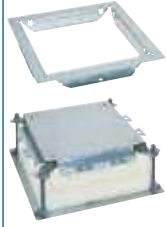

* MRP - Maximum Retail Price Inclusive of all taxes including GST.
Red Cat.Nos - new products

Bold Cat.Nos are products normally available with Legrand (India) Stockists. Cat.Nos that are not bold - delivery within 4 - 8 weeks from the date of order. Bold packing quantity is our mandatory packing. Orders to be placed by Legrand (India) Stockist in multiples of the same.

Frame and Lid Floor Boxes for Concrete Floor Selection Chart

FLOOR BOX TYPE	FLOOR BOX CAPACITY	FLOOR BOX CAT.NOS	BACKBOX TO SELECT ACCORDING TO CONCRETE SCREED DEPTH					FINISHING PLATES (OPTIONAL)		
										
SOCKETS IN HORIZONTAL POSITION			77 - 90⁽¹⁾⁽²⁾ mm	80 - 110⁽²⁾ mm	76 - 125⁽²⁾ mm	110 - 170 mm	150 - 250 mm			
	12 (3 x 4) modules	0 807 09	0 880 90	0 881 90	0 880 80 + 0 880 81	+	0 880 88 + 0 880 86	+	0 880 88	0 880 15
	18 (3 x 6) modules	0 807 10	0 880 91	0 881 91	0 880 80 + 0 880 82					0 880 16
	24 (3 x 8) modules	0 807 11	0 880 92	0 881 92	0 880 80 + 0 880 83					0 880 17
	12 (3 x 4) modules	0 807 27	0 880 90	0 881 90	0 880 80 + 0 880 81					0 880 45
	18 (3 x 6) modules	0 807 28	0 880 91	0 881 91	0 880 80 + 0 880 82					0 880 46
	24 (3 x 8) modules	0 807 29	0 880 92	0 881 92	0 880 80 + 0 880 83					0 880 47
SOCKETS IN VERTICAL POSITION			69 - 90⁽¹⁾ mm	72 - 110 mm	68 - 125 mm	110 - 170 mm	150 - 250 mm			
	8 (2 x 4) modules	0 807 12	0 880 90	0 881 90	0 880 80 + 0 880 81	+	0 880 88 + 0 880 86	+	0 880 88	0 880 15
	12 (2 x 6) modules	0 807 13	0 880 91	0 881 91	0 880 80 + 0 880 82					0 880 16
	16 (2 x 8) modules	0 807 14	0 880 92	0 881 92	0 880 80 + 0 880 83					0 880 17
	8 (2 x 4) modules	0 807 30	0 880 90	0 881 90	0 880 80 + 0 880 81					0 880 45
	12 (2 x 6) modules	0 807 31	0 880 91	0 881 91	0 880 80 + 0 880 82					0 880 46
	16 (2 x 8) modules	0 807 32	0 880 92	0 881 92	0 880 80 + 0 880 83					0 880 47

1: From 90 mm to 200 mm with the fixing kit for elevating and leveling Cat.No 0 807 55
2: Minimum dimensions when used with straight plugs





Floor Box

Effortless Access. Seamless Installation.















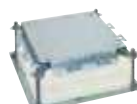

- Power and data access closer to the user for maximum convenience
- Quick and easy installation with snap-in design
- Minimal tools required for faster, hassle-free setup

Frame and Lid Floor Boxes for Concrete Floor

Selection Chart

FLOOR BOX TYPE	FLOOR BOX CAPACITY	FLOOR BOX CAT.NOS	BACKBOX TO SELECT ACCORDING TO CONCRETE SCREED DEPTH				FINISHING PLATES (OPTIONAL)		
			89 - 90 ⁽¹⁾⁽²⁾ mm	88 - 122 ⁽²⁾ mm	110 - 170 mm	150 - 250 mm			
SOCKETS IN HORIZONTAL POSITION			89 - 90⁽¹⁾⁽²⁾ mm	88 - 122⁽²⁾ mm	110 - 170 mm	150 - 250 mm			
METAL FLUSH LID	12 (3 x 4) modules	0 807 45	0 880 90	0 880 80 + 0 880 81	+	+	0 881 45		
	18 (3 x 6) modules	0 807 46	0 880 91	0 880 80 + 0 880 82			0 880 88 + 0 880 86 + 0 881 42	0 880 88	0 881 46
	24 (3 x 8) modules	0 807 47	0 880 92	0 880 80 + 0 880 83					0 881 47
SOCKETS IN VERTICAL POSITION			82 - 90⁽¹⁾ mm	81 - 122 mm	110 - 170 mm	150 - 250 mm			
METAL FLUSH LID	8 (2 x 4) modules	0 807 48	0 880 90	0 880 80 + 0 880 81	+	+	0 881 45		
	12 (2 x 6) modules	0 807 49	0 880 91	0 880 80 + 0 880 82			0 880 88 + 0 880 86 + 0 881 42	0 880 88	0 881 46
	16 (2 x 8) modules	0 807 50	0 880 92	0 880 80 + 0 880 83					0 881 47

Mouting Principle

	=		OR		OR		+		OR		OR		+	
Floor box with sockets in horizontal position		Type : Standard Frame : Horizontal Lid : Plastic Grey		Type : Standard Frame : Horizontal Lid : SS Finish		Type : Flush Frame : Horizontal Lid : SS Finish		Regular Back Box		Box (Plastic) (Not compatible with Flush type Lid)		Universal adjustable Back Box		Arteor Accessories
	=		OR		OR		+		OR		OR		+	
Floor box with sockets in vertical position		Type : Standard Frame : Vertical Lid : Plastic Grey		Type : Standard Frame : Vertical Lid : SS Finish		Type : Flush Frame : Vertical Lid : SS Finish		Regular Back Box		Box (Plastic) (Not compatible with Flush type Lid)		Universal adjustable Back Box		Arteor Accessories

DLP™

Universal & Snap-On Trunking Essentials



DLP™ Trunking is a cable management solution designed for power and data distribution in electrical installations. Compliant with EN 50085-2-1, it supports structured cable routing while accommodating mechanisms such as Arteor.

Features

- Flexible system to adapt to every kind of wall-building configuration
- A new aesthetics, colour : RAL 9003 brilliant white
- A RoHS product = lead free product.
- High resistance against UV to limit the change of the colour during the life of the installation
- Non-Flame Propagating; material : high impact self-extinguishing

Benefits

- Simplifies installation with snap-on covers and clip-on accessories
- Provides flexible cable routing and easy system expansion
- Supports organized separation of power and data circuits
- Ensures durable performance with impact-resistant

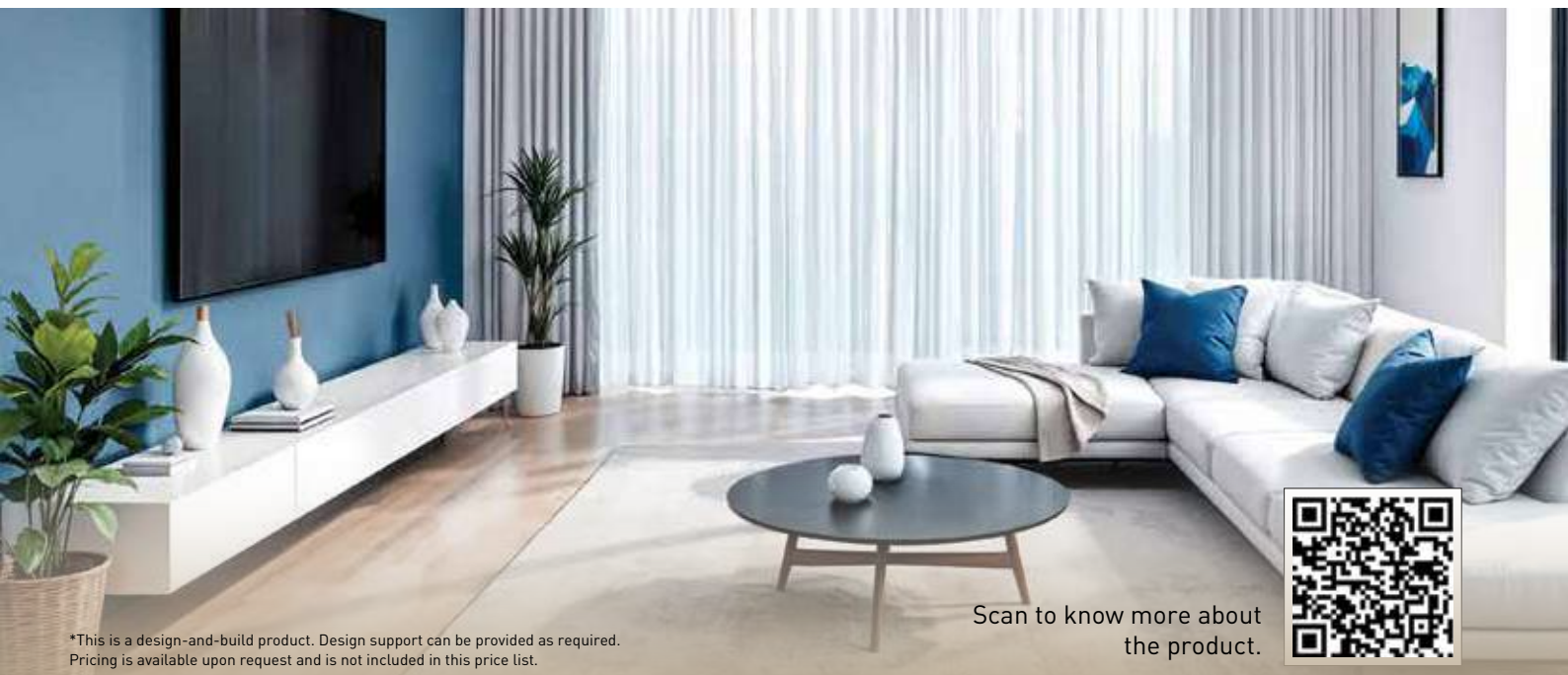

*This is a design-and-build product. Design support can be provided as required. Pricing is available upon request and is not included in this price list.

Scan to know more about the product.



DLP™ Mini-Trunking

Flexible and Aesthetic Cable Management Solution



DLP™ Mini-Trunking offers a practical solution for organized cable routing, protection, and distribution in electrical installations. Its modular design enables neat cable management while supporting easy integration of wiring accessories across residential, commercial, and service environments.

Features

- Flexible system to adapt to every kind of wall-building configuration
- A new aesthetics, colour : RAL 9003 brilliant white
- A RoHS product = lead free product.
- High resistance against UV to limit the change of the colour during the life of the installation
- Non-Flame Propagating; material : high impact self-extinguishing

Benefits

- Simplifies installation with clip-on assembly and easy maintenance access
- Ensures organized cable routing with safe separation of circuits
- Provides durable protection with IP40 enclosure and IK07 impact resistance
- Delivers a clean aesthetic finish suitable for visible installations

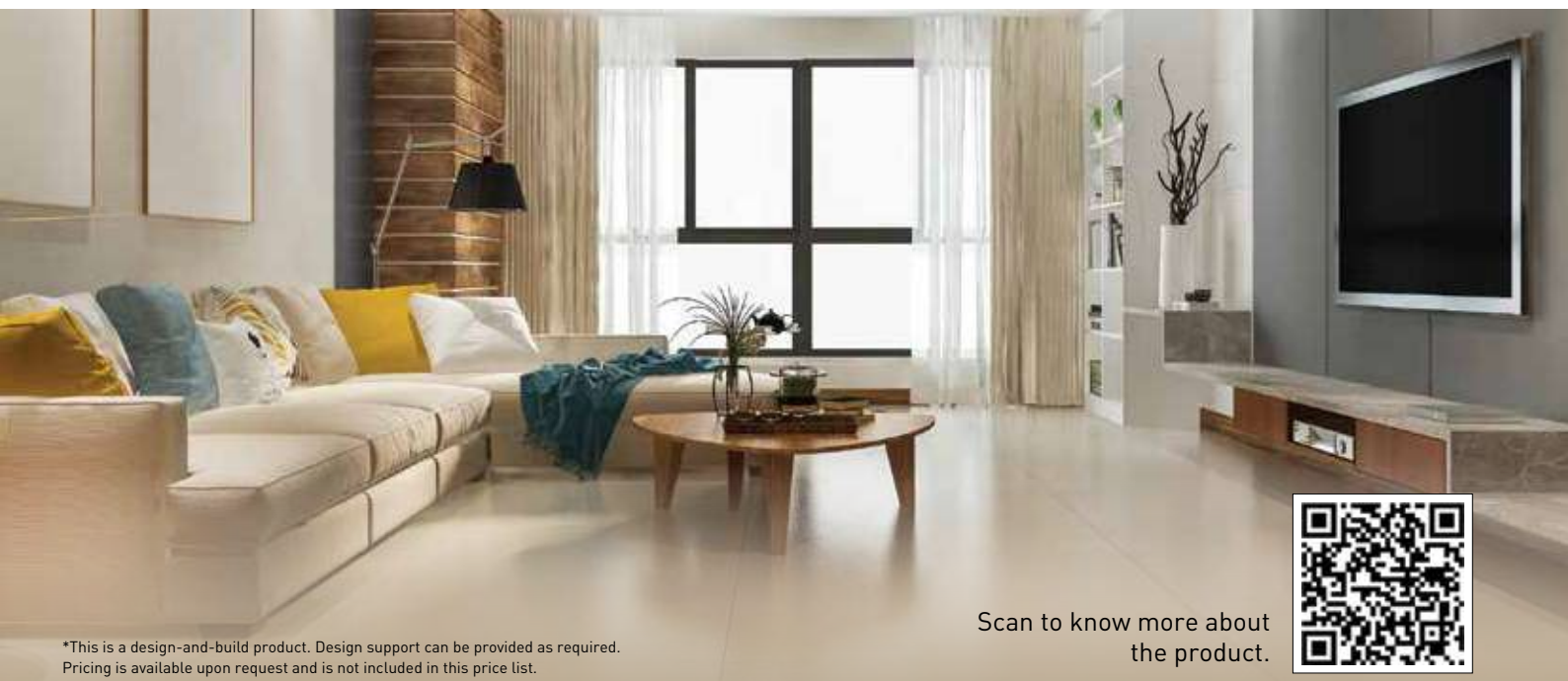

*This is a design-and-build product. Design support can be provided as required. Pricing is available upon request and is not included in this price list.

Scan to know more about
the product.



Snap-on Trunking (Premium) Routing Sections & Accessories

TRUNKING			TRUNKING		
Number of compartments	Cover width	Cross-section (mm)	Monobloc: body + cover ⁽¹⁾	Divider	Fishplate body joint
SNAP-ON TRUNKING - 45 mm cover					
	45	50 x 80	○ 0756 01	0756 09	0756 61
	45	50 x 105	0756 02	0756 09	0756 62
	45 45	50 x 130	0756 03	-	0756 61
	45 45	50 x 145	0756 04	-	0756 63
	45 45 45	50 x 180	0756 06	-	0756 61
<small>1: Partition(s) integral to the body 2: Internal and external corner angles supplied with multi-compartment partition joint</small>					

Mechanisms for Snap-On Trunking

Mounting Functions		
The Arteor sockets to be fitted with Soluclip accessory which has following features: - Anti-slip - Anti-pullout - IP 4X - Perfect finish		0756 90

Installation Principle for Sockets For Snap-On Trunking

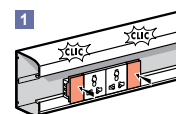

Snap the sockets directly into the trunking

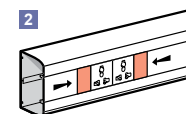

Install the covers

Installation Principle for Arteor Functions

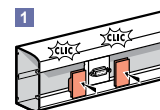

Snap on the mechanism and fix with Soluclips

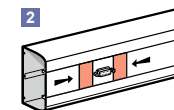

Install the covers

AND ACCESSORIES			ANGLES			JUNCTIONS				ACCESSORIES
Stick-on body joint	Cover joint	End cap	Internal angles ⁽²⁾	External angles	Flat angles	Flat junctions with width 80 mm	Flat junctions with width 105 mm	Angled junctions 85/105/130 mm	Junction with floor duct 50 x 12/92 x 20	Extra cover
0756 66	0756 69	0756 11	0756 21	0756 31	0756 41	0756 71	-	0756 81 + 0756 21	0756 88	0756 08
0756 67	0756 69	0756 12	0756 22	0756 32	0756 42	0756 72	0756 76	0756 81 + 0756 22	0756 88	0756 08
0756 66	2 x 0756 69	0756 13	0756 23	0756 33	0756 43	0756 71	0756 75	0756 81 + 0756 23	0756 88	0756 08
① 0756 66 + ② 0756 67	2 x 0756 69	0756 14	0756 24	0756 34	0756 44	① 0756 71 + ② 0756 72	① 0756 75 + ② 0756 76	0756 81 + 0756 24	0756 88	0756 08
0756 66	3 x 0756 69	0756 16	0756 26	0756 36	0756 46	0756 71	0756 75	0756 81 + 0756 26	0756 88	0756 08

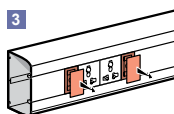

3 Disengage the finishing piece

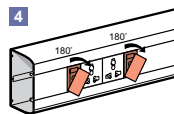

4 Rotate the finishing piece by 180°

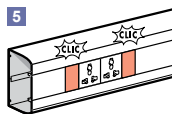

5 Snap on the finishing piece

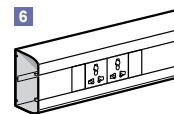

6 An impeccable result

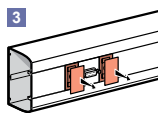

3 Disengage the finishing piece

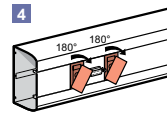

4 Rotate the finishing piece by 180°

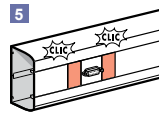

5 Snap on the finishing piece

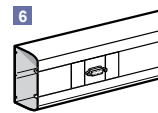



























6 An impeccable result





DLP PVC Universal Adaptable Trunking Systems for Installations

Base, Covers, Partitions, Finishing Accessories & Mounting Wiring Accessories

Selection Chart for Installation Of Trunking, Accessories And Arteor™

Trunking			Covers		Clip on partition		Arteor™ frames				
Number of compartments	Cover(s) width	Section (mm)									
			Flexible	Partitions separation	Plastic	Aluminium	1 module	2 module	3 module	4 module	6 module
 0104 12	1 1 x 65 	80 x 50	0105 21	0105 82	-	-	-	0109 52	0109 53	0109 54	0109 56
 0104 22	1 1 x 85 	105 x 50	0105 22	0105 82	-	-	-	0109 92	0109 93	0109 94	0109 96
	2 2 x 40 		0105 20	0105 82	0104 72	0111 06	0109 10	-	-	-	-
 0104 32	1 1 x 130 	150 x 50	0105 24	0105 82	-	-	-	-	-	-	-
	2 2 x 65 		0105 21	0105 82	0104 72	0111 06	-	0109 52	0109 53	0109 54	0109 56
	2 1 x 40 + 1 x 85 		0105 20 + 0105 22	0105 82	0104 72	0111 06	0109 10	0109 92	0109 93	0109 94	0109 96
	3 3 x 40 		0105 20	0105 82	0104 72 x 2	0111 06 x 2	0109 10	-	-	-	-
 0104 52	1 1 x 180 	195 x 50	0105 26	0105 82	-	-	-	-	-	-	-
	2 2 x 85 		0105 22	0105 82	0104 72	0111 06	-	0109 92	0109 93	0109 94	0109 96
	2 1 x 40 + 1 x 130 			0105 82	0104 72	0111 06	0109 10	-	-	-	-
	3 1 x 85 + 2 x 40 			0105 82	0104 72 x 2	0111 06 x 2	0109 10	0109 92	0109 93	0109 94	0109 62
	3 1 x 40 + 2 x 65 			0105 82	0104 72 x 2	0111 06 x 2	0109 10	0109 52	0109 53	0109 54	0109 56
	4 4 x 40 			0105 20	0105 82	0104 72 x 3	0111 06 x 3	0109 10	-	-	-

Selection Chart for Installation Trunking, Accessories And Arteor™

Section (mm)	Wall crossing 	Capacity change 	Partition junction 	Cable tie base 	Insulating unit for Arteor™ modules 	Earth Link
80 x 50 / 105 x 50	0106 98	0106 87 + 0106 88 + 0106 89 (to be used for partition)	0106 89	0308 81	2 Module Combined to get 4/6 Module 0109 27	0111 88
150 x 50 / 195 x 50	0106 99					

Selection Chart for Installation Of Trunking, Additional Accessories

Cover	Bases		Internal angles 80° - 100°			External angles 60° - 120°			Flat angles		Flat junction			
Joint for covers	Base joint	End caps	Angles	Partition junction	VDI access.	Angles	Partition junction	VDI access.	Angles	VDI access.	Angles	Partition junction	VDI access.	Clips
0108 01	0106 91	0107 22	0106 02	-	0107 80	0106 22	-	0107 81	0107 67	0107 82	0107 32	-	0107 83	0106 82
0108 02	0106 91	0107 02	0106 02	-	0107 80	0106 22	-	0107 81	0107 85	0107 82	0107 32	-	0107 83	0106 82
0108 00	0106 91	0107 02	0106 02	0106 11	-	0106 22	0106 32	-	-	-	0107 32	0107 42	-	0106 82
0108 04	0106 91	0107 03	0106 02	-	-	0106 22	-	-	0107 89	-	0107 32	-	-	0106 86
0108 01	0106 91	0107 03	0106 02	0106 11	0107 80	0106 22	0106 32	0107 81	0107 89	0107 82	0107 32	0107 42	0107 83	0106 82
0108 02	0106 91	0107 03	0106 02	0106 11	0107 80	0106 22	0106 32	0107 81	0107 89	0107 82	0107 32	0107 42	0107 83	0106 82
0108 00	0106 91	0107 03	0106 02	0106 11 x2	-	0106 22	0106 32 x2	-	0107 89	-	0107 32	0107 42	-	0106 82
0108 06	0106 91	0107 07	0106 02	-	-	0106 22	-	-	0107 92	-	0107 32	-	-	0106 86
0108 02	0106 91	0107 07	0106 02	0106 11	0107 80	0106 22	0106 32	0107 81	0107 92	0107 82	0107 32	0107 42	0107 83	0106 82
	0106 91	0107 07	0106 02	0106 11	0107 80	0106 22	0106 32	0107 81	0107 92	0107 82	0107 32	0107 42	0107 83	
	0106 91	0107 07	0106 02	0106 11 x2	0107 80	0106 22	0106 32 x2	0107 81	0107 92	0107 82	010732	0107 42	0107 83	0106 82
	0106 91	0107 07	0106 02	0106 11 x2	0107 80	0106 22	0106 32 x2	0107 81	0107 92	010782	0107 32	0107 42	010783	0106 82
0108 00	0106 91	0107 07	0106 02	0106 11 x3	-	0106 22	0106 32 x3	-	0107 92	-	0107 32	0107 42	-	0106 82

DLP mini trunking systems







For Cable Distribution





Selection Chart for Dlp Mini Trunking

	Length	Finishing Accessories				Junction Elements
WHITE	2 m	End cap	Internal angle	External angle	Flat angle	Flat junction
32 x 12.5	0300 15	0312 03	0302 51	0302 51	0302 53	0302 54
32 x 16	0308 04	0312 07	0333 25	0333 25	0333 27	0333 30
32 x 20	0300 17	0312 09	0302 71	0302 71	0302 73	0302 74

DLP Aluminium Universal Trunking System

Selection Chart of Sections, Covers & Accessories
 Selection Chart of Support for Wiring Accessories

TRUNKING AND ACCESSORIES									
Width (mm)	Nos. of compartments	Covers width	Cat. nos.	Rigid covers 				 Cover Joint	 Trunking Base Joint
				65 mm width	85 mm width	130 mm width	180 mm width		
105 x 50	1 	1 x 85	111 00	-	0111 11	-	-	0111 63	0111 66
150 x 50	2 	2 x 65	0111 02	2 x 0111 10	-	-	-	0111 62	0111 66
195 x 50	2 	2 x 85	0111 04	-	2 x 0111 11	-	-	0111 63	0111 66

SUPPORT FOR WIRING ACCESSORIES		
60 mm fixing centers : Arteur™	Cover depths	
No of module	65 mm	85 mm
2 modules 	0112 02	0112 12
3 modules 	0112 03	0112 13
4 modules 	0112 04	0112 14
6 modules 	0112 06	0112 16

Insulation resistance : the entire DLP range, including accessories, have insulation resistance above 5 Megaohms

DLP TRUNKING SYSTEM ALUMINIUM

with Aluminium Adaptable DLP Trunking,
 Get Better Styling Too !

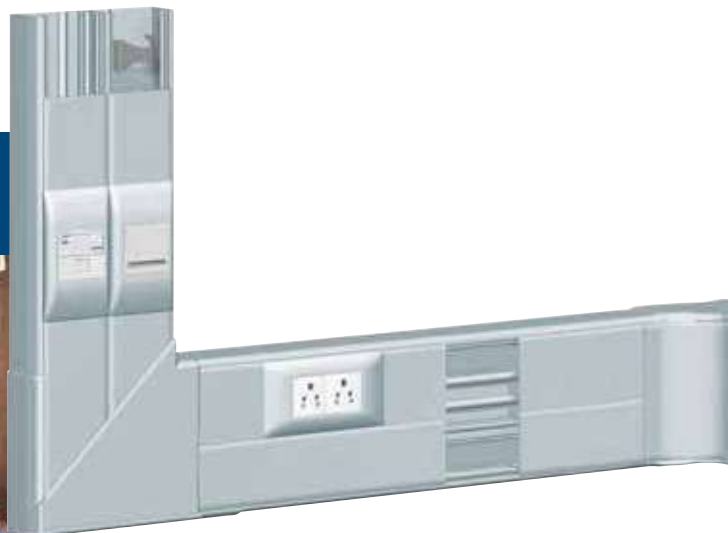

SELECTION CHART OF ACCESSORIES (continued)

Dividers		End cap	Internal angles	External angles	Flat angles	Junction Flat junction*	Clips	Earth link
Clip-on partition	Separation partition							
-	0111 08	0111 58	0112 21	0112 32	0112 43	0112 51	0106 82	0111 88
0111 06	0111 08	0111 60	0112 27	0112 38	0112 45	0112 51	0106 82	0111 88
0111 06	0111 08	0111 61	0112 29	0112 40	0112 47	0112 51	0106 82	0111 88

(1) To be used with angle covers. (2) To be used with rigid covers

TABLE OF CAPACITIES

	Cross-section (mm ²) Max. Ø (mm ²)	105 x 50	150 x 50		195 x 50	
		cover 85	cover 65	cover 65	cover 85	cover 85
Trunking only	Cross-section	4330	3020	3020	5350	5350
	Max. Ø	28	43	43	55	55
With Arteor™ / support	Cross-section	2300	1470	1470	3320	3320
	Max. Ø	2 x 24	18	18	33	33

*To tap off 105 mm wide trunking with 85 mm cover

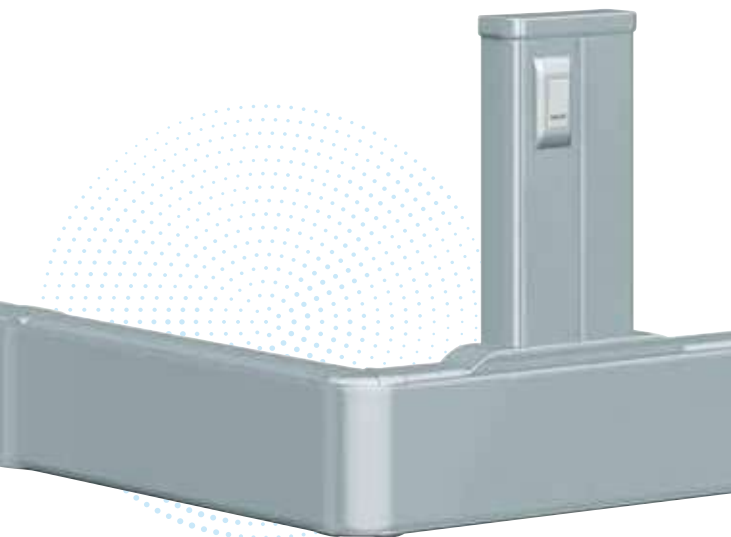

SAVE TIME

- Flexibility : multi-covers
- Removable separation
- Angles delivered pre-cut, ready to use
- Fast fixing device support
- Uniform colours for the entire installation
- Arteor™ wiring accessories go with aluminium adaptable DLP trunking

DLP Snap-On (Premium)

Cat.Nos	Description	MRP* ₹ / Unit	Pack
---------	-------------	------------------	------

Dlp Snap-On

0756 01	TRK 50X80 1CV45 White 2M	1650	20 ⁽¹⁾
0756 02	TRK 50X105 1CV45 White 2M	2101	12 ⁽¹⁾
0756 03	TRK 50X130 2CV45 White 2M	2892	12 ⁽¹⁾
0756 04	TRK 50X145 2CV45 White 2M	3741	8 ⁽¹⁾
0756 06	TRK 50X180 3CV45 White 2M	4113	8 ⁽¹⁾

Divider

0756 09	Separation Part TRK	384	26 ⁽¹⁾
---------	---------------------	-----	-------------------

Extra Cover

0756 08	Flexible CV45 TRK	645	20 ⁽¹⁾
---------	-------------------	-----	-------------------

Joints

Fishplate Body Joint

0756 61	Coupling Set 50X80/130/180	576	10
0756 62	Coupling Set 50X105	768	10
0756 63	Coupling Set 50X145	840	10

Stick-On Body Joint

0756 66	Body Joint 50X80/130/145/180	373	20
0756 67	Body Joint 50X105/145	452	20

Cover Joint

0756 69	45 Cover Joint TRK	203	10
---------	--------------------	-----	----

End Caps

0756 11	End Cap TRK 50X80	360	10
0756 12	End Cap TRK 50X105	420	10
0756 13	End Cap TRK 50X130	565	5
0756 14	End Cap TRK 50X145	612	5
0756 16	End Cap TRK 50X180	632	5

Height Spacer

0105 80	Height Spacer Charcol Grey	848	24 ⁽¹⁾
---------	----------------------------	-----	-------------------

Soluclip Accessory

Fishplate Body Joint

0756 90	Soluclip TRK	325	10
---------	--------------	-----	----

Angles

Internal Angles

0756 21	Inter Angle TRK 50X80	768	10
0756 22	Inter Angle TRK 50X105	1074	10
0756 23	Inter Angle TRK 50X130	1808	5
0756 24	Inter Angle TRK 50X145	2904	5
0756 26	Inter Angle TRK 50X180	2577	5

External Angles

0756 31	Exter Angle TRK 50X80	1615	10
0756 32	Exter Angle TRK 50X105	2463	10
0756 33	Exter Angle TRK 50X130	3345	5
0756 34	Exter Angle TRK 50X145	3944	5
0756 36	Exter Angle TRK 50X180	4679	5

Flat Angles

0756 41	Flat Angle TRK 50X80	938	10
0756 42	Flat Angle TRK 50X105	1231	10
0756 43	Flat Angle TRK 50X130	2463	5
0756 44	Flat Angle TRK 50X145	2870	5
0756 46	Flat Angle TRK 50X180	4621	5

DLP

Cat.Nos	Description	MRP* ₹ / Unit	Pack
---------	-------------	------------------	------

Junctions

Flat Junctions with 80 mm width

0756 71	Flat Junct Side 17 >50X80	1288	5
0756 72	Flat Junct Side 29 >50X80	1288	5

For 105 mm wide Upward Trunking

0756 75	Flat Junct Side 17 >50X105	1266	5
0756 76	Flat Junct Side 29 >50X105	1379	5

Angled Junction

Must be used in conjunction with an internal angle

0756 81	Angled Junction >50X80/105/130	2848	5
---------	--------------------------------	------	---

Junction with Floor Duct

0756 88	Floor Junction >50X12/92X20	1503	5
---------	-----------------------------	------	---

DLP Mini Trunking

Mini-trunking system

Standard length 2 meters; Price per meter
Mini-trunking - 32 x 12.5 mm

0300 15	Mini TRK 32X125 White	202	80 ⁽¹⁾
---------	-----------------------	-----	-------------------

Finishing Accessories

0312 03	End Cap For 32X125	112	20/400
0302 51	Int/Ext Angle For 32X125	154	10/100
0302 53	Flat Angle For 32X125	166	10/100
0302 54	Flat Junction For 32X125	217	10/200
0336 03	White 32X10/125 Cover Gasket	218	20

Mini-Trunking - 32 x 16 mm

0308 04	Mini TRK 32X16 White 210	269	60 ⁽¹⁾
---------	--------------------------	-----	-------------------

Finishing Accessories

0312 07	End Cap For 32X16	163	10
0333 25	Int/Ext Angle For 32X16	217	10
0333 27	Flat Angle For 32X16	179	10
0333 30	Flat Junction For 32X16	409	10
0336 04	White 32X16/20 Cover Gasket	315	20

Mini-Trunking - 32 x 20 mm

0300 17	Mini TRK 32X20 White 210	352	50 ⁽¹⁾
---------	--------------------------	-----	-------------------

Finishing Accessories

0312 09	End Cap For 32X20	234	10
0302 71	Int/Ext Angle For 32X20	217	10
0302 73	Flat Angle For 32X20	272	10
0302 74	Flat Junction For 32X20	459	10
0336 04	White 32X16/20 Cover Gasket	315	20

Bold Cat.Nos are products normally available with Legrand (India) Stockists. Cat.Nos that are not bold - delivery within 4 - 8 weeks from the date of order. Bold packing quantity is our mandatory packing. Orders to be placed by Legrand (India) Stockist in multiples of the same.

DLP PVC Universal Trunking

Cat.Nos	Description	MRP* ₹ / Unit	Pack
---------	-------------	------------------	------

Standard length 2 meters; Price per meter Trunking

Bodies

Supplied without cover

0104 12	Plastic TRK 80x50	994	20 ⁽¹⁾
0104 22	Plastic TRK 105x50	1243	20 ⁽¹⁾
0104 32	Plastic TRK 150X50	2113	10 ⁽¹⁾
0104 52	Plastic TRK 195X50	2915	8 ⁽¹⁾

Flexible Cover

Fits onto the whole branch including in internal or external angles

0105 20	Flexible Cover 40 Width	552	20 ⁽¹⁾
0105 21	Flexible Cover 65 Width	580	24 ⁽¹⁾
0105 22	Flexible Cover 85 Width	626	20 ⁽¹⁾
0105 24	Flexible Cover 130 Width	1209	8
0105 26	Flexible Cover 180 Width	1582	8 ⁽¹⁾

Partitions

0105 82	Separation Partitions	328	24 ⁽¹⁾
0104 72	Clip On Partitions	486	48 ⁽¹⁾
0111 06	Aluminium Clip On Partition	2520	12 ⁽¹⁾

Joints

0106 91	Base Joint	113	20/200
0108 00	Joint For 40 Width Cover	237	10/100
0108 01	Joint For 65 Width Cover	267	10/100
0108 02	Joint For 85 Width Cover	294	10/100
0108 04	Joint For 130 Width Cover	520	10/100
0108 06	Joint For 180 Width Cover	602	10/100

Angles and end caps

Internal and External Angles

Include the 2 components for the top and bottom of the trunking on which the flexible cover is fitted

0106 02	Int Angle Adj Frm 80 Deg	724	10/40
0106 22	Ext Angle Adj Frm 60 Deg	723	10/50

Flat Angle

0107 67	Flat Angle TRK 80X50	1028	10
0107 85	Flat Angle TRK 105X50	1074	10
0107 89	Flat Angle TRK 150X50	3571	5
0107 92	Flat Angle for 195X50	4577	2

End Cap

0107 02	End Cap TRK 105x50	322	20/100
0107 07	End Cap TRK 195X50	610	5/50
0107 22	End Cap TRK 80X50	294	10
0107 03	End Cap TRK 150x50	582	10/50

Junctions

0107 32	Flat Junc. Tap-off to 50mm wide profile	1333	10
0107 35	Flat Junc. Tap-off to 80mm wide profile	780	5
0107 36	Flat Junc. Tap-off to 105 wide profile with 85mm cover	768	5/25
0107 37	Flat Junc. Tap-off to 105 wide profile with 65mm cover	768	5/25

* MRP - Maximum Retail Price Inclusive of all taxes including GST.

DLP PVC Universal Trunking

Cat.Nos	Description	MRP* ₹ / Unit	Pack
---------	-------------	------------------	------

Accessories

Holding Cables in Place

0106 82	Clips For 40/65/85 Width cover	101	50
0106 86	Clips For 130 Width Cover	169	50

VDI Accessories

0107 80	VDI Acc For Int Angle	1152	5/50
0107 81	VDI Acc For Flat Ext Angle	1243	5/50
0107 82	VDI Acc For Flat Angle	1322	5/50
0107 83	VDI Acc For Flat Junction	1593	5/50

Additional Accessories

0106 98	Wall Crossing for 80/105 x 50	1288	5/25
0106 99	Wall Crossing for 150/195 x 50	1333	5/25
0308 81	Cable Ties Base	46	100/1000
0111 88	Earth Link	485	20/500

Capacity Change

Allows to increase 15 mm height of trunking to preserve the space of wiring with a flat junction or a support equipment

0106 87	Capacity Change	441	40
0106 88	Capacity Change Set of 4	566	10/100
0106 89	Partition Junction for capacity change	565	5/50

Supports for Mounting Wiring Accessories

Arteor™ supports

To be equipped with Arteor socket outlets
Clip-on supports which can be fitted side by side
Supplied with finishing plate

0109 10	1M Frame For 40 Cover	480	5/50
0109 52	2M Frame For 65 Cover	506	20
0109 92	2M Frame For 85 Cover	506	20
0109 53	3M Frame For 65 Cover	544	5/50
0109 93	3M Frame For 85 Cover	561	5/50
0109 54	4M Frame For 65 Cover	576	10/50
0109 94	4M Frame For 85 Cover	592	20
0109 56	6M Frame For 65 Cover	444	5/25
0109 96	6M Frame For 85 Cover	630	10
0109 27	Insu Unit 2M To Create 4/6/8M	452	10/100

Legrand Lexic supports

0109 25	Lex Supp For 2M For DLP 65	1570	5
0109 35	Lex Supp For 3M For DLP 85	1853	5
0109 65	Lex Supp 8M For DLP 130	2090	5
0109 00	Hypra Skt Supp For 130 Cove	3029	5

Bold Cat.Nos are products normally available with Legrand (India) Stockists.
Cat.Nos that are not bold - delivery within 4 - 8 weeks from the date of order.
Bold packing quantity is our mandatory packing. Orders to be placed by Legrand (India) Stockist in multiples of the same.

DLP-S Universal Trunking

Cat.Nos	Description	MRP* ₹ / Unit	Pack
---------	-------------	------------------	------

Standard length 2 meters; Price per meter
Trunking

Body with cover

6380 38	DLP-S TRK+CVR 100X502M	1435	12 ⁽¹⁾
---------	---------------------------	------	-------------------

Partition

6380 08	DLP-S Separation Partition	336	32 ⁽¹⁾
---------	----------------------------	-----	-------------------

Joints

6380 36	DLP-S Body Joint 100X50	160	10
6380 01	DLP-S Cover Joint 75	237	50

Angles and end caps

Variable angles

6380 31	DLP-S Variable Int Angle 100X50	700	10
6380 32	DLP-S Variable Ext Angle 100X50	700	10

Fixed angles

6380 11	DLP-S Int Angle For 100X50	362	20
6380 12	DLP-S Ext Angle For 100X50	372	20

Flat angle

6380 13	DLP-S Flat Angle For 100X50	803	16
---------	--------------------------------	-----	----

End cap

6380 35	DLP-S End Cap 100X50	204	20
---------	----------------------	-----	----

Bracket

6380 05	DLP-S Bracket CV80	169	10/100
---------	--------------------	-----	--------

Junction

6380 34	DLP-S Tee 100X50	1763	5
---------	------------------	------	---

Supports for Mounting Wiring Accessories

Arteor™ & Myrius supports

Clip-on supports which can be fitted side by side
Supplied with finishing plate

6380 71	DLP-S 2 Modules Frame	440	10
6380 72	DLP-S 4 Modules Frame	640	5
6380 73	DLP-S 6 Modules Frame	759	5

DLP Aluminium Universal Trunking

0111 00	Aluminium TRK 105X50,W/O Cove	6520	8 ⁽¹⁾
0111 02	Aluminium TRK 150 X 50	8226	4 ⁽¹⁾
0111 04	Aluminium TRK 195 X 50	11942	4 ⁽¹⁾

Cover & Partition

0111 10	Aluminium TRK Flexible Cover 65	1638	16 ⁽¹⁾
0111 11	Aluminium Cover 85 Width	2147	16 ⁽¹⁾
0111 08	Seperation Partition	1130	24 ⁽¹⁾
0111 06	Aluminium Clip On Partition	2520	12 ⁽¹⁾

Finishing Accessories

0111 66	TRK Body Joint	476	20/100
0111 62	Cover Joint 65mm	531	10
0111 63	Cover Joint 85mm	700	10/100

* MRP - Maximum Retail Price Inclusive of all taxes including GST.

DLP Aluminium Universal Trunking

Cat.Nos	Description	MRP* ₹ / Unit	Pack
---------	-------------	------------------	------

Finishing Accessories

0111 58	End Cap For Al 105X50	1164	20/100
0111 60	End Cap For Al 150X50	2486	10
0111 61	End Cap For Al 195X50	2949	10
0112 43	Flat Angle For 105x50	10000	10
0112 45	Flat Angle For 150x50	16837	5
0112 47	Flat Angle For 195x50	17368	2
0112 32	Ext Angle 50x105 1 Cov85	12463	1
0112 38	Ext Angle 50X150 2 Cov65	25809	1
0112 40	Ext Angle 50X195 2 Cov85	26950	1
0112 21	Int Angle 50x105 1 Cov85	11209	1
0112 27	Int Angle 50X150 2 Cov65	25629	1
0112 29	Int Angle 50X195 2 Cov85	26770	1
0112 51	Flat Junction	13571	5

Supports for Arteor™ for Cover 85 mm width

To be equipped with Arteor socket outlets

0112 12	2 Arteor Module Frame	814	20
0112 13	3 Arteor Module Frame	950	20
0112 14	4 Arteor Module Frame	949	20
0112 16	6 Module Arteor Frame For DLP	2260	10

Supports for Arteor™ for Cover 65 mm width

To be equipped with Arteor socket outlets

0112 02	2 Module Arteor Frame For 65	734	20
0112 03	3 Module Arteor Frame	904	20
0112 04	4 Module Arteor Frame	938	20
0112 06	6 Module Arteor Frame	1107	10

Cabling Accessories

0106 82	Clips For 40/65/85+Cover	101	50
0111 88	Earth Link	485	20
0308 81	Cable Ties Base	46	100

Bold Cat.Nos are products normally available with Legrand (India) Stockists.
Cat.Nos that are not bold - delivery within 4 - 8 weeks from the date of order.
Bold packing quantity is our mandatory packing. Orders to be placed by
Legrand (India) Stockist in multiples of the same.

Aluminum Snap-on Column

Cat.Nos	Description	MRP* ₹ / Unit	Pack
---------	-------------	------------------	------

2 Compartments Mini - Columns

6530 23	Mini Column 2 Cpts 0.68M White	17281	1
6530 24	Mini Column 2 Cpts 0.68M Al	24409	1

Accessories for 1 or 2 Compartments Mini- Columns

6530 84	Table For Mini Column White	47795	1
6530 86	Foot For Mini Column White	31526	1
6530 87	Foot For Mini Column Aluminium	33154	1
6530 88	4 Wheels With Cable Holder	21758	1

Fixing Clip

6038 57	Fixing Clip Wh	373	10
6038 58	Fixing Clip Al	1039	10

1 Compartment - 2 Sides Columns

White Finish

6530 10	Snap On Column 1 Cpt 270M White	45364	1
6530 13	Snap On Column 1 Cpt 390M White	58366	1

Aluminium Finish

6530 11	Snap On Column 1 Cpt 270M Aluminium	52877	1
6530 14	Snap On Column 1 Cpt 390M Aluminium	66506	1

2 compartments columns

White Finish

6530 30	Snap On Column 2 Cpts 270M White	43934	1
6530 33	Snap On Column 2 Cpts 390M White	56749	1

Aluminium Finish

6530 31	Snap On Column 2 Cpts 270M Aluminium	58982	1
6530 34	Snap On Column 2 Cpts 390M Aluminium	76263	1

* MRP - Maximum Retail Price Inclusive of all taxes including GST.

Accessories for 1 or 2 compartments

Cat.Nos	Description	MRP* ₹ / Unit	Pack
---------	-------------	------------------	------

Finishing Kit for Telescopic Pole for 1 or 2 Compartments Columns

6530 66	White Finishing Kit For Column	3047	1
6530 67	Gr Finishing Kit For Column	3256	1

Fixing Clip

6038 57	Fixing Clip Wh	373	10
6038 58	Fixing Clip Al	1039	10

Snap-On Columns & Mini-Columns:

The natural choice with Arteor wiring accessories



6530 24



Assembled Mini-column with Arteor WDs, Table, movable foot & set of 4 wheels



6530 11



6530 31

AUDIO/VIDEO

Preterminated Sockets

Reliable Connectivity for Modern Spaces

Preterminated audio/video sockets enable seamless connectivity for high-definition audio and video systems. Designed for quick installation and dependable signal transmission, they support professional and residential setups including home theatres, conference rooms, and multimedia environments.

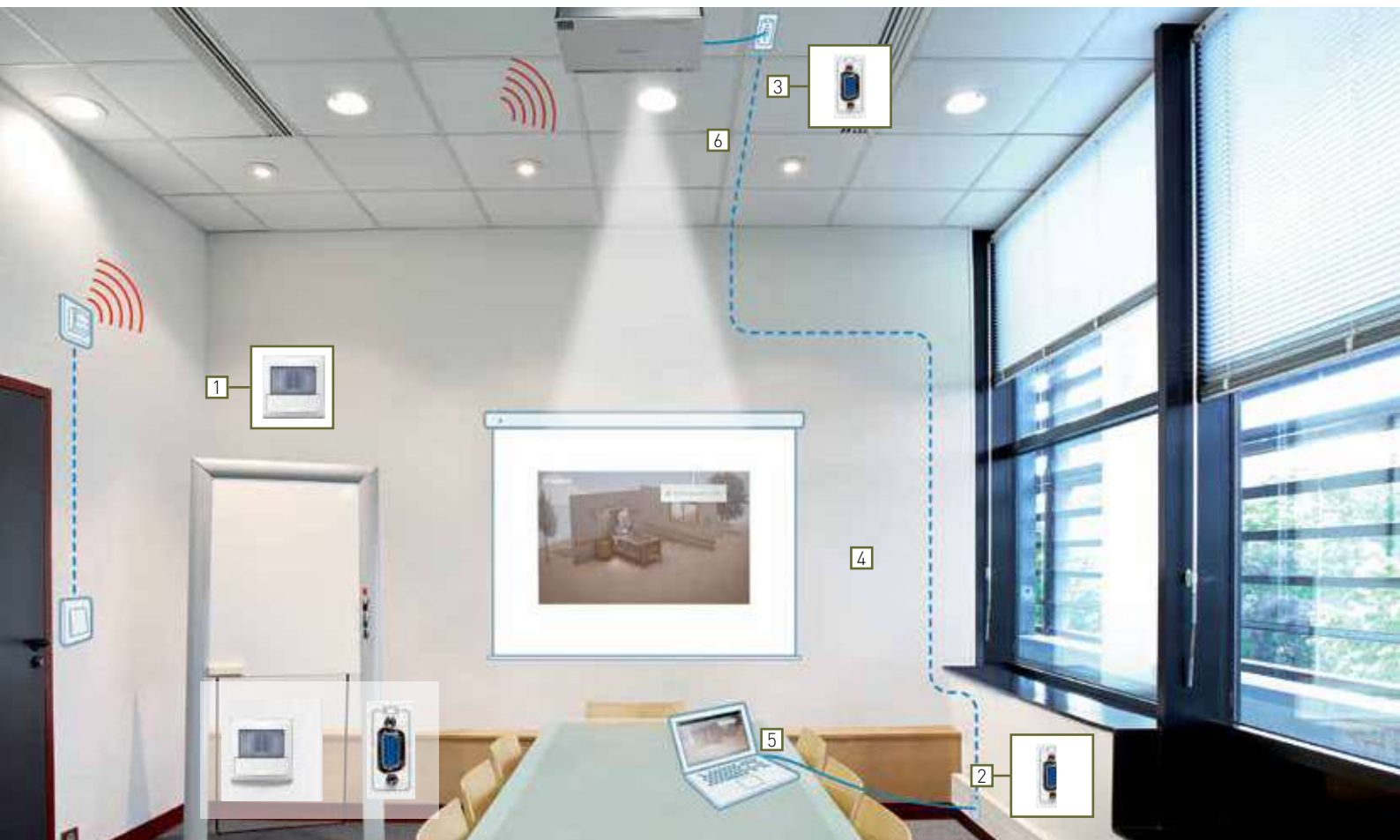

1 Infrared ON/STANDBY control for video projector associated with a pushbutton Cat.No 0 787 99/5 720 89

2 3 Preterminated HD15 sockets Cat.No 0 787 77/5 720 97

4 10 m male/male HD15 cords Cat.No 0 517 23

5 6 Male/male HD 15 cords

Linkeo™

Data Center PDUs

Scalable Power Distribution for Critical IT Infrastructure



Linkeo™ Data Center PDUs deliver scalable and energy-efficient power distribution for IT racks and critical infrastructure. Designed for modern data centers, they support multiple configurations and intelligent monitoring to ensure reliable power management and operational continuity.

Features

- Multiple PDU configurations including Basic, Metered and Switched models
- High-precision power monitoring with $\pm 1\%$ metering accuracy and LCD display
- Secure power connections using C13/C19 outlets with 100N cord locking and hydraulic magnetic MCB protection
- Advanced monitoring and integration with cascading controllers, wireless sensors, and DCIM protocol support

Benefits

- Maximizes uptime with intelligent monitoring and hot-swappable control modules
- Reduces operational complexity through cascading architecture and efficient rack-level management
- Enables greener data center operations with energy-efficient design and minimal packaging
- Enables fast global deployment with 15-day CTO lead times



Scan to know more about the product.

LCS³

Structured Cabling System

Complete Cabling Infrastructure from Room to Workstation



LCS³ is a comprehensive structured cabling solution designed to connect network rooms to workstations with high-speed, reliable infrastructure. Supporting both copper and fibre technologies, it enables scalable network installations for offices, data centers, and enterprise environments.

Features

- Complete structured cabling system connecting network rooms to workstations
- Supports copper cabling from Cat5e to Cat6A (up to 500 MHz) and optical fibre
- Modular copper and high-density fibre panels with integrated cord locking system
- Compatible with Legrand cabling accessories and cable management solutions

Benefits

- Ensures long-term network reliability with a 20-year system warranty
- Delivers high-bandwidth performance for modern data and communication needs
- Enables scalable infrastructure for expanding enterprise networks
- Improves connection security by preventing accidental cable disconnections



Scan to know more about the product.

Micro DC

Integrated Micro Data Center for Edge IT Environments



Legrand Integrated MDC is designed to support IT infrastructure in edge and distributed environments. It provides a secure, space-efficient enclosure that enables reliable IT operations in locations where traditional data center infrastructure is not feasible.

Features

- 42U high-strength rack enclosure with lockable doors, removable vented side panels, and up to 1500 kg load capacity
- Integrated power and cooling systems including UPS, intelligent PDUs, and precision air conditioning
- Advanced monitoring and security with environmental sensors, cameras, access control, and fire protection
- Optimized airflow management using air-seal kits and blanking panels

Benefits

- Accelerates edge IT deployment in remote sites such as warehouses, banks, and branch offices
- Optimizes space utilization with compact, self-contained infrastructure
- Enhances operational reliability through continuous monitoring and controlled environments
- Simplifies infrastructure management with modular architecture and centralized visibility

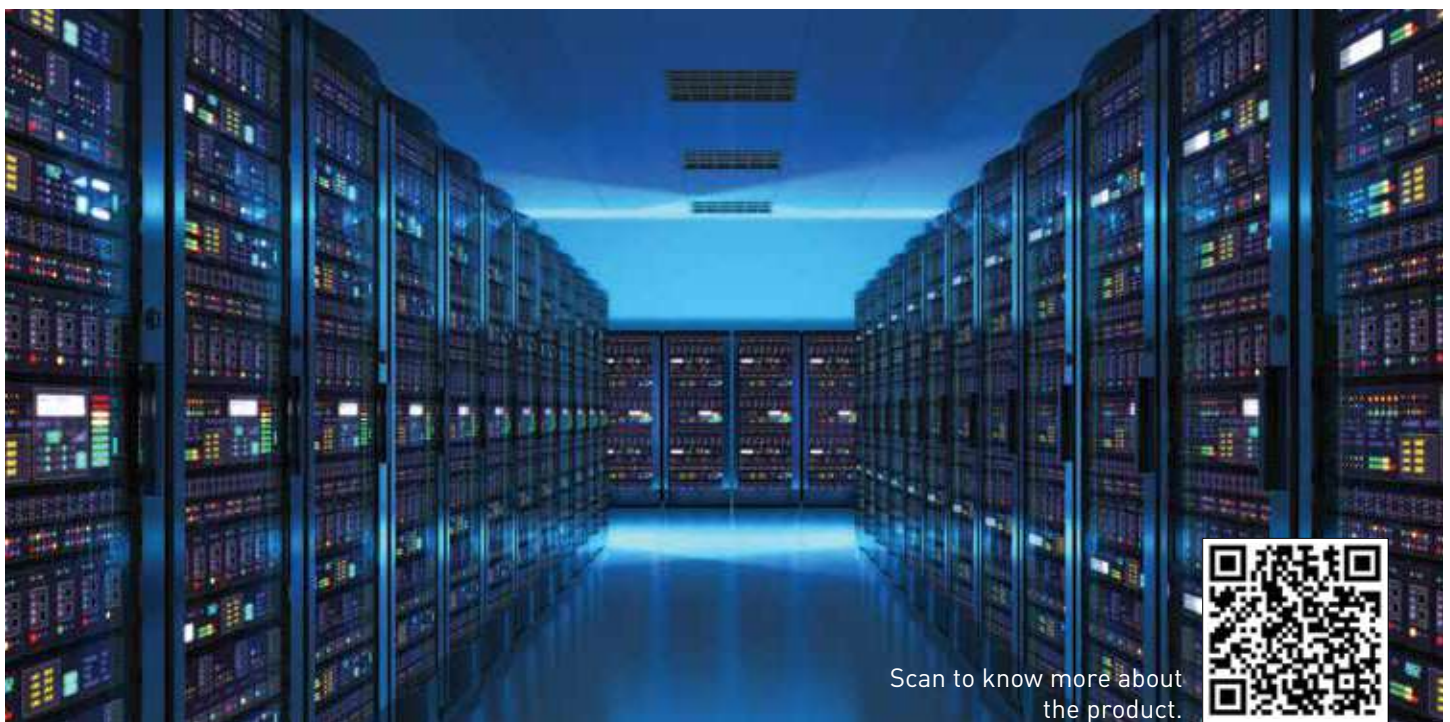

Scan to know more about the product.



LINKEO

Structured Cabling System

Build Reliable Network Connections

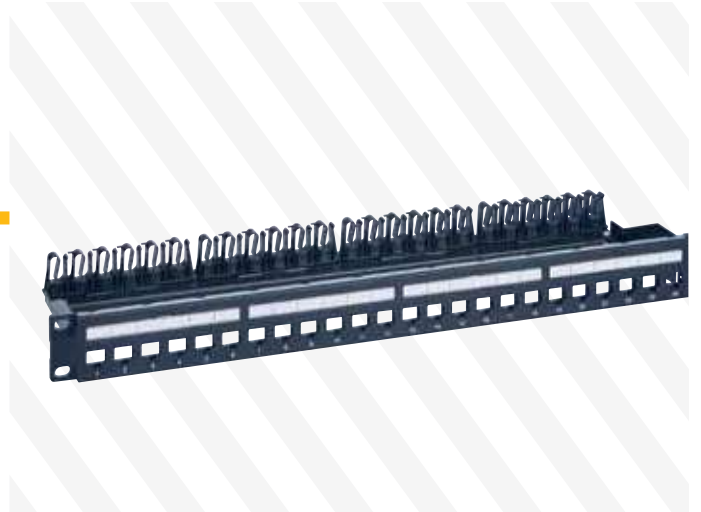

LINKEO™ C is a structured cabling system designed for LAN networks in small and large commercial environments. Featuring ergonomic toolless RJ45 keystone connectors, patch panels, cables, and outlets, it enables fast installation and dependable data performance with a 25-year system warranty.

Features

- Toolless RJ45 keystone connectors with ergonomic lever design for fast termination
- Supports Cat6, and Cat6A UTP cabling up to 10 Gbps
- Pre-positioned patch panels for simplified cable organisation and installation
- Color-coded identification tabs with eco-friendly packaging made from 100% recycled cardboard

Benefits

- Speeds up installation and re-termination with efficient toolless design
- Ensures reliable, high-performance data transmission for enterprise networks
- Simplifies cable management and network organisation in racks and work areas
- Supports sustainable installations with recyclable packaging



Scan to know more about the product.



LCS³ Basic PDU

Cat.Nos	Description	MRP* ₹ / Unit	Pack
LCS³ Basic PDU			
6468 07	PDU 19P 6 C19	■	-
6468 09	PDU 19P 6 C13 + 2 C19	■	-
6468 14	PDU 19P 10 C13	■	-
6468 15	PDU 19P 11 C13	■	-
6468 43	PDU 19P 6 C13 + AMPEREMETRE	■	-
6468 44	PDU 19P 6 C19 + AMPEREMETRE	■	-
6468 45	PDU 19P 6 C13 1 C19 + AMPEREMETRE	■	-
6468 56	PDU 0U 24 C13 + DISJ	■	-
6468 57	PDU 0U 24 C13 + DISJ + CORD	■	-
6468 60	PDU 0U 20C13 + 4C19 + DISJ	■	-
6468 61	PDU 0U 20C13 + 4C19 +DISJ+CORD	■	-
6468 65	PDU 0U 20C13 + 4C19 +DISJ+AMP	■	-
6468 70	PDU 0U TRIPHASE 18C13 + 6C19	■	-
6468 75	PDU 0U TRI 18C13 + 6C19 +AMP	■	-

LINKEO DC PDU

Single Phase PDU

Basic

6469 71I	PDU HD 1P 32A 24+12 C13/C19	■	-
6469 72I	PDU HD 1P 32A 36+6 C13/C19	■	-
6469 63I	PDU 1P 32A 12+12 C13/C19	■	-
6469 66I	PDU LPM 1P 32A 20+4 C13/C19	■	-
6469 60I	PDU 1P 16A 18+6 C13/C19	■	-
6469 61I	PDU 1 P 16A 20+4 C13/C19	■	-
6469 62I	PDU 1P 32A 20+4 C13/C19	■	-

Smart Metered

6461 00I	MB 19P 1P16A 12 O LCK C20	■	-
6461 01I	MN 19P 1P16A 12 O LCK C20	■	-
6461 02I	MB 0U 1P16A 18+4 LCK IEC	■	-
6461 03I	MN 0U 1P16A 18+4 LCK IEC	■	-
6461 04I	MB 0U 1P32A 20+4 LCK IEC	■	-
6461 05I	MN 0U 1P32A 20+4 LCK IEC	■	-

Smart Metered HD

6461 06I	HD MB 0U 1P32A 24+12 LCK IEC	■	-
6461 07I	HD MN 0U 1P32A 24+12 LCK IEC	■	-
6461 08I	HD MB 0U 1P32A 36+6 LCK IEC	■	-
6461 09I	HD MN 0U 1P32A 36+6 LCK IEC	■	-

* MRP - Maximum Retail Price Inclusive of all taxes including GST.

■ Price available on request.

Red Cat.Nos - new products

LINKEO DC PDU

Cat.Nos	Description	MRP* ₹ / Unit	Pack
Smart Switched			
6461 20I	SB 0U 1P16A 21+3 LCK C20	■	-
6461 21I	SN 0U 1P16A 21+3 LCK C20	■	-
6461 22I	SB 0U 1P32A 20+2 LCK IEC	■	-
6461 23I	SN 0U 1P32A 20+2 LCK IEC	■	-
6461 24I	SB 0U 1P32A 21+3 LCK IEC	■	-
6461 25I	SN 0U 1P32A 21+3 LCK IEC	■	-

Three Phase PDU

Basic

6469 64I	PDU 3P 16A 21+3 C13/C19	■	-
6469 65	PDU 3P 16A 24+6 C13/C19 IEC	■	-
6469 10I	PDU 0U 3P-16A 36C13+6C19 IEC	■	-
6469 11I	PDU 0U 3P-16A 24C13+12C19 IEC	■	-

Basic HD PDU

646970I	PDU HD LPM 3P 16A 36+6 C13/C19	■	-
646973I	PDU HD 3P 32A 24+12 C13/C19	■	-
646974I	PDU HD 3P 32A 36+12 C13/C19	■	-
646975	PDU HD 3P 32A 36+6 C13/C19	■	-

Smart Metered HD

6461 10I	HD MB 0U 3P16A 36+6 LCK IEC	■	-
6461 11I	HD MN 0U 3P16A 36+6 LCK IEC	■	-
6461 12I	HD MB 0U 3P32A 24+12 LCK IEC	■	-
6461 13I	HD MN 0U 3P32A 24+12 LCK IEC	■	-
6461 14I	HD MB 0U 3P32A 36+12 LCK IEC	■	-
6461 15	HD MN 0U 3P32A 36+12 LCK IEC	■	-
6461 16	HD MB 0U 3P32A 36+6 LCK IEC	■	-
6461 17	HD MN 0U 3P32A 36+6 LCK IEC	■	-
6461 18I	PDU SW BASE 3P 32A 24+12 IEC	■	-
6461 19I	PDU SW NODE 3P 32A 24+12 IEC	■	-
6461 26I	SB 0U 3P16A 21+3 LCK IEC	■	-
6461 27I	SN 0U 3P16A 21+3 LCK IEC	■	-
6461 28I	SB 0U 3P16A 24+6 LCK IEC	■	-
6461 29I	SN 0U 3P16A 24+6 LCK IEC	■	-

Bold Cat.Nos are products normally available with Legrand (India) Stockists. Cat.Nos that are not bold - delivery within 4 - 8 weeks from the date of order. Bold packing quantity is our mandatory packing. Orders to be placed by Legrand (India) Stockist in multiples of the same.

Power Cords

Cat.Nos	Description	MRP* ₹ / Unit	Pack
Power Cords C14 to C13 Plugs			
6441 00	10 CORDS C14-C13 LOCK 0.5M BLK	■	1
6441 01	10 CORDS C14-C13 LOCK 1M BLK	■	
6441 02	10 CORDS C14-C13 LOCK 1.5M BLK	■	
6441 03	10 CORDS C14-C13 LOCK 2M BLK	■	
6441 06	10 CORDS C14-C13 LOCK 0.5M RED	■	
6441 07	10 CORDS C14-C13 LOCK 1M RED	■	
6441 08	10 CORDS C14-C13 LOCK 1.5M RED	■	
6441 09	10 CORDS C14-C13 LOCK 2M RED	■	
6441 12	10 CORDS C14-C13 LOCK 0.5M BLU	■	
6441 13	10 CORDS C14-C13 LOCK 1M BLU	■	
6441 14	10 CORDS C14-C13 LOCK 1.5M BLU	■	
6441 15	10 CORDS C14-C13 LOCK 2M BLU	■	

Power Cords C20 to C19 Plugs

6442 01	10 CORDS C20-C19 LOCK 1M BLK	■	
6442 02	10 CORDS C20-C19 LOCK 1.5M BLK	■	
6442 03	10 CORDS C20-C19 LOCK 2M BLK	■	
6442 07	10 CORDS C20-C19 LOCK 1M RED	■	
6442 08	10 CORDS C20-C19 LOCK 1.5M RED	■	
6442 09	10 CORDS C20-C19 LOCK 2M RED	■	
6442 13	10 CORDS C20-C19 LOCK 1M BLU	■	
6442 14	10 CORDS C20-C19 LOCK 1.5M BLU	■	
6442 15	10 CORDS C20-C19 LOCK 2M BLU	■	

Accessories

6461 30	NODE CONTROLLER	■	
6469 05	POWER CABLE, C19 TO IEC, 1.5M	■	
6469 06	POWER CABLE, C19 TO IEC, 3M	■	
6468 94	6 OBTURATEURS C13 + CLE	■	
6468 95	6 OBTURATEURS C19 + CLE	■	

Wireless Sensors

6460 03	WIRELESS T/H SENSOR	■	
6460 04	WIRELESS CONTACTCLOSURE SENSOR	■	
6460 05	EMMETTEUR USB CAPTEURS SSFIL	■	
6460 06	EXTERNAL FIXING PLATES X20	■	
6339 10	POWER STRIP 19 INCH WITH MCB	■	

* MRP - Maximum Retail Price Inclusive of all taxes including GST.
 ■ Price available on request.
 Red Cat.Nos - new products

Legrand Cabling System Linkeo C Category 6 & 6_A

Cat.Nos	Description	MRP* ₹ / Unit	Pack
---------	-------------	------------------	------

Linkeo C 19" Unloaded Patch Panel to be Equipped with 24 RJ 45 Connectors

6328 50	19" Unloaded Patch panel	■	
---------	--------------------------	---	--

Linkeo C Keystone Connectors

Cat. 6 RJ 45 Connectors

6329 09	RJ45 CAT 6 UTP KEYSTONE	■	
---------	-------------------------	---	--

Cat. 6A RJ 45 Connectors

6329 06	RJ45 CAT 6A UTP KEYSTONE	■	
---------	--------------------------	---	--

Linkeo C Keystone Faceplates

RJ 45 Linkeo Faceplates

6327 94	1 PORT	■	
6327 95	2 PORT	■	
6329 00	4 PORT	■	

Angled RJ 45 Linkeo Faceplates

6327 96	1 PORT	■	
6327 97	2 PORT	■	

Legrand cabling system LCS³ Category 6

Marking Kit

0518 90	Kit of 200 coloured rings for marking RJ 45 cords Rings to be clipped to the patch cords	■	1
---------	---	---	---



Legrand cabling system LCS³ Category 6_A

Cat. 6_A Patch Panels Equipped with 24 RJ 45 Connectors

Flat panels

24 RJ 45 connectors - 1 U

0337 70	UTP	■	1
0337 72	STP	■	1



Flat 24-Connector Patch Panels - 1 U to be Equipped

Flat panel with empty cassettes to be equipped with connectors

Equipped with 4 automatic extraction cassettes for cat. 5e to cat. 8 RJ 45 connectors

0337 90	19" panel - 1 U	■	1
---------	-----------------	---	---



Bold Cat.Nos are products normally available with Legrand (India) Stockists. Cat.Nos that are not bold - delivery within 4 - 8 weeks from the date of order. Bold packing quantity is our mandatory packing. Orders to be placed by Legrand (India) Stockist in multiples of the same.

Legrand Cabling System LCS³ Category 6_A

Cat.Nos	Description	MRP* ₹ / Unit	Pack
---------	-------------	------------------	------

Empty flat panel to be equipped with cassettes

It can accept a maximum of 4 automatic extraction cassettes:
- copper
- fibre optic

0337 91	19" panel - 1 U	■	1
---------	-----------------	---	---

Flat High Density 48-Connector Patch Panel - 1 U to be equipped

0337 93	19" panel - 1 U	■	1
---------	-----------------	---	---

Angled 24-Connector Patch Panel - 1 U

Angled panel to be equipped with connectors

It can accept up to 24 cat. 5e to cat. 8 RJ 45 connectors

0337 92	19" panel - 1 U	■	1
---------	-----------------	---	---

Angled High Density 48-Connector Patch Panel - 1 U To Be Equipped

Angled panel to be equipped with connectors

It can accept up to 48 cat. 5e to cat. 6A RJ 45 connectors

0337 94	19" panel - 1 U	■	1
---------	-----------------	---	---

High Density Cat. 6a RJ 45 Connectors

0337 73	UTP	■	1
0337 75	STP	■	1

Common Accessories for Flat & Angled Panels

Port Blanking Modules

0337 56	Divisible 6 port blanking plate for sealing from 1 to 6 ports	■	10
---------	---	---	----

Cord Management

0337 59	For use with new generation Quick-Fix; they provide side cord management	■	1
---------	--	---	---

Specific Accessories for Flat Panels

Cassette For Flat Panels to be Equipped

0337 55	Empty removable cassette to be equipped with connectors. It can accept 6 cat. 5e to cat. 8 connectors Extraction by simple pressure of the cassette making installation and maintenance easier Possibility of removing each connector individually	■	1
---------	--	---	---

High Density Cassette for Flat Panels to be Equipped

0337 95	Empty removable cassette to be equipped with connectors; it can accept 12 cat. 5e to cat. 6 _A connectors Extraction by simple pressure of the cassette, making installation and maintenance easier	■	1
---------	--	---	---

* MRP - Maximum Retail Price Inclusive of all taxes including GST.
■ Price available on request.

Legrand Cabling System LCS³ Category 6_A

Cat.Nos	Description	MRP* ₹ / Unit	Pack
---------	-------------	------------------	------

Blanking Cassette

0337 57	Used to blank the panel	■	1
---------	-------------------------	---	---

Specific Accessories for Angled Panels

Angled Panel Cover

0337 58	For optimised management of the air flow inside the cabinet	■	1
---------	---	---	---

Cables for Local Networks Cat. 6A

F/UTP - 4 Pairs

Performance 500 MHz

0327 78	Length 500 m Supplied on reel. Weight 25 kg	■	500 ¹
---------	---	---	------------------

F/UTP - 2 x 4 Pairs

Performance 500 MHz

0328 78	Length 500 m Supplied on reel. Weight 65 kg	■	500 ¹
---------	--	---	------------------

S/FTP - 4 Pairs

Performance 600 MHz

0327 77	Length 500 m Supplied on reel. Weight 30 kg	■	500 ¹
---------	--	---	------------------

RJ 45 Patch Cords & User Cords Cat. 6A

PVC - U/UTP Unscreened Impedance 100 Ω

0518 82	Length 1 m	■	1
0518 83	Length 2 m	■	1
0518 84	Length 3 m	■	1
0518 85	Length 5 m	■	1

LSZH - U/UTP Unscreened Impedance 100 Ω

0518 78	Length 1 m	■	1
0518 79	Length 2 m	■	1
0518 80	Length 3 m	■	1
0518 81	Length 5 m	■	1
0518 74	Length 1 m	■	1
0518 75	Length 2 m	■	1
0518 76	Length 3 m	■	1
0518 77	Length 5 m	■	1

Bold Cat.Nos are products normally available with Legrand (India) Stockists. Cat.Nos that are not bold - delivery within 4 - 8 weeks from the date of order. Bold packing quantity is our mandatory packing. Orders to be placed by Legrand (India) Stockist in multiples of the same.

Legrand Cabling System LCS³ Category 6_A

Cat.Nos	Description	MRP* ₹ / Unit	Pack
PVC - S/FTP Shielded Impedance 100 Ω			
0518 16	Length 0.5 m	■	1
0517 80	Length 1 m	■	5
0517 81	Length 2 m	■	5
0517 82	Length 3 m	■	5
0517 83	Length 5 m	■	5

Cat.Nos	Description	MRP* ₹ / Unit	Pack
LSZH - S/FTP Shielded Impedance 100 Ω			
0518 70	Length 1 m	■	1
0518 71	Length 2 m	■	1
0518 72	Length 3 m	■	1
0518 73	Length 5 m	■	1
0518 66	Length 1 m	■	1
0518 67	Length 2 m	■	1
0518 68	Length 3 m	■	1
0518 69	Length 5 m	■	1

Arteor RJ 45 Socket Cat. 6_A

360° Metal Shielding

STP - 1 Module

5734 32	White	■	20
5728 06	Magnesium	■	10
5723 52	White with green shutter	■	10
5728 52	Magnesium with green shutter	■	10
5723 51	White with orange shutter	■	10
5728 51	Magnesium with orange shutter	■	10

STP with Controlled Access - 2 Modules

Supplied with 2 Keys for 5 Sockets

5723 50	White with Red Shutter	■	5
5728 50	Magnesium with Red Shutter	■	5



5734 32

Legrand Cabling System LCS³ Category 6_A

Cat.Nos	Description	MRP* ₹ / Unit	Pack
UTP - 1 module			
5723 49	White	■	10
5728 49	Magnesium	■	10
5723 59	White with Green Shutter	■	10
5728 59	Magnesium with Green Shutter	■	10
5723 58	White with Orange Shutter	■	10
5728 58	Magnesium with Orange Shutter	■	10

UTP with Controlled Access - 2 modules

Supplied with 2 keys for 5 sockets

5723 57	White with Red Shutter	■	5
5728 57	Magnesium with Red Shutter	■	5



5723 57



0337 93



0337 61



0337 94



0337 63



0337 56



0337 59



0337 55

Legrand Cabling System LCS³ Category 6

Cat. 6 Patch Panels Equipped with 24 RJ 45 Connectors

Flat panels

24 RJ 45 connectors - 1 U

0337 60	UTP	■	1
0337 61	FTP	■	1
0337 62	STP	■	1

Flat 24-Connector Patch Panels - 1 U to be Equipped

Flat panel with empty cassettes to be equipped with connectors

Equipped with 4 automatic extraction cassettes for cat. 5e to cat. 8 RJ 45 connectors

0337 90	19" Panel - 1 U	■	1
---------	-----------------	---	---

Empty flat panel to be equipped with cassettes

It can accept a maximum of 4 automatic extraction cassettes:
- copper
- fibre optic

0337 91	19" Patch Panel - 1 U	■	1
---------	-----------------------	---	---

Flat High Density 48-Connector Patch Panel - 1 U to be Equipped

0337 93	19" Panel - 1 U	■	1
---------	-----------------	---	---

Angled 24-Connector Patch Panels - 1 U

Angled Panel to be Equipped with Connectors

It can accept up to 24 cat. 5e to cat. 8 RJ 45 connectors

0337 92	19" Panel - 1 U	■	1
---------	-----------------	---	---

Angled High Density 48-Connector Patch Panel - 1 U to be Equipped

Angled panel to be equipped with connectors

It can accept up to 48 cat. 5e to cat. 6_A RJ 45 connectors

0337 94	19" Panel - 1 U	■	1
---------	-----------------	---	---

* MRP - Maximum Retail Price Inclusive of all taxes including GST.
■ Price available on request.

Bold Cat.Nos are products normally available with Legrand (India) Stockists.
Cat.Nos that are not bold - delivery within 4 - 8 weeks from the date of order.
Bold packing quantity is our mandatory packing. Orders to be placed by
Legrand (India) Stockist in multiples of the same.

Legrand Cabling System LCS³ Category 6

Cat.Nos	Description	MRP* ₹ / Unit	Pack
---------	-------------	------------------	------

Cat. 6 High Density RJ 45 Connectors

0337 63	UTP	■	1
0337 64	FTP	■	1
0337 65	STP	■	1

Common Accessories for Flat & Angled Panels

Port Blanking Modules

0337 56	Divisible 6 port blanking plate for sealing from 1 to 6 ports	■	10
---------	---	---	----

Cord Management

0337 59	For use with new generation Quick-Fix; they provide side cord management	■	1
---------	--	---	---

Specific Accessories for Flat Panels

0337 55	Cassette for flat panels to be equipped	■	1
0337 95	High density cassette for flat panels to be equipped	■	1
0337 57	Blanking cassette Used to blank the panel	■	1



0337 57

Specific Accessories for Angled Panels

Angled Panel Cover

0337 58	For optimised management of the air flow inside the cabinet	■	
---------	---	---	--



0337 58

Cables for Cat. 6 LANs

Cables with 4 pairs or 2 x 4 twisted pairs
100 ohms. Colour code TIA/EIA
Conform to standards ISO/IEC 11801
Ed. 2.0, EN 50173-1 and TIA/EIA 568 C

LSZH - U/UTP - 4 pairs

0327 54I	Length 305 m. Supplied in cardboard box Weight 16 kg., Violet RAL 4005	■	305 ¹
0328 61	Length 500 m. Supplied on reel. Weight 18 kg. Blue RAL 5015	■	500 ¹

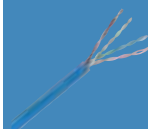

0327 54I

PVC - U/UTP - 4 pairs

0327 55W	Length 305 m Supplied in cardboard box, Weight 13 kg., White RAL 9003, MOQ 50 Box	■	305 ¹
0327 55	Length 305 m Supplied in cardboard box Weight 13 kg. Blue RAL 5015	■	305 ¹
0327 55O	Length 305 m Supplied in cardboard box, Weight 13 kg., Orange RAL 2008, MOQ 50 Box	■	305 ¹
0327 55G	Length 305 m Supplied in cardboard box, Weight 13 kg., Green RAL 6018/6024, MOQ 50 Box	■	305 ¹

* MRP - Maximum Retail Price Inclusive of all taxes including GST.

■ Price available on request.

Legrand Cabling System LCS³ Category 6

Cat.Nos	Description	MRP* ₹ / Unit	Pack
---------	-------------	------------------	------

LSZH - U/UTP - 4 pairs

0328 61	Length 500 m Supplied on reel. Weight 18 kg	■	500 ¹
---------	--	---	------------------

PVC - U/UTP - 4 pairs

0327 55	Length 305m Supplied in cardboard box. Weight 13 kg	■	305 ¹
---------	---	---	------------------

LSZH - F/UTP - 4 pairs

0328 56	Length 305 m. Supplied on reel. Weight 17 kg	■	305 ¹
0327 56	Length 500 m. Supplied on reel. Weight 25 kg	■	500 ¹

PVC - F/UTP - 4 pairs

0328 57	Length 305 m Supplied in cardboard box. Weight 17 kg	■	305 ¹
0327 58	Length 500 m Supplied on reel. Weight 25 kg	■	500 ¹

LSZH - F/UTP - 2 x 4 pairs

0327 76	Length 500 m. Supplied on reel. Weight 48 kg	■	500 ¹
---------	---	---	------------------

LSZH - SF/UTP - 4 pairs

0327 57	Length 500 m. Supplied on reel. Weight 29 kg	■	500 ¹
---------	---	---	------------------

PVC - SF/UTP - 4 pairs

0327 59	Length 500 m. Supplied on reel. Weight 30 kg	■	500 ¹
---------	---	---	------------------

LSZH - F/FTP - 2 x 4 pairs

0327 98	Length 500 m. Weight 62 kg	■	
---------	----------------------------	---	--

PVC - F/FTP - 4 pairs

0327 99	Length 500 m. Weight 25,2 kg	■	
---------	------------------------------	---	--

Rj 45 Patch Cords & User Cords Cat. 6

RJ 45 - RJ 45 right

PVC - U/UTP unshielded impedance 100 Ω

0518 18	Length 0.5 m	■	1
0517 72	Length 1 m	■	1
0517 73	Length 2 m	■	1
0517 74	Length 3 m	■	1
0517 75	Length 5 m	■	1

Bold Cat.Nos are products normally available with Legrand (India) Stockists. Cat.Nos that are not bold - delivery within 4 - 8 weeks from the date of order. Bold packing quantity is our mandatory packing. Orders to be placed by Legrand (India) Stockist in multiples of the same.

Legrand Cabling System LCS³ Category 6

Cat.Nos	Description	MRP* ₹ / Unit	Pack
---------	-------------	------------------	------

LSZH - U/UTP unscreened impedance 100 Ω

0518 62	Length 1 m	■	1
0518 63	Length 2 m	■	1
0518 64	Length 3 m	■	1
0518 65	Length 5 m	■	1
0518 58	Length 1 m	■	1
0518 59	Length 2 m	■	1
0518 60	Length 3 m	■	1
0518 61	Length 5 m	■	1

PVC - F/UTP screened impedance 100 Ω

0518 15	Length 0.5 m	■	1
0517 62	Length 1 m	■	1
0517 63	Length 2 m	■	1
0517 64	Length 3 m	■	1
0517 65	Length 5 m	■	1

LSZH - F/UTP screened impedance 100 Ω

0518 54	Length 1 m	■	1
0518 55	Length 2 m	■	1
0518 56	Length 3 m	■	1
0518 57	Length 5 m	■	1
0518 50	Length 1 m	■	1
0518 51	Length 2 m	■	1
0518 52	Length 3 m	■	1
0518 53	Length 5 m	■	1

PVC - SF/UTP shielded impedance 100 Ω

0517 52	Length 1 m	■	5
0517 53	Length 2 m	■	5
0517 54	Length 3 m	■	5
0517 55	Length 5 m	■	5

* MRP - Maximum Retail Price Inclusive of all taxes including GST.
■ Price available on request.

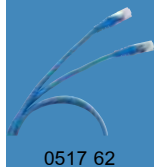

0517 62

Legrand Cabling System LCS³ Category 6

Cat.Nos	Description	MRP* ₹ / Unit	Pack
---------	-------------	------------------	------

RJ 45 sockets

Sockets with LCS³ quick-fixing crimp connector. Take AWG 22 single-core cables up to AWG 26 and AWG 24 multicore cables. Contacts marked with dual colour code and wiring schemes T 568 A and T 568 B. Conforming to standards ISO/IEC 11801 Ed. 2.0, EN 50173-1 and TIA/EIA 568

Arteor RJ 45 socket cat. 6

UTP - 1 module

5734 28	Information Socket - RJ45 - Cat 6 - UTP - 1 Module	■	20
5736 28	Information Socket - RJ45 - Cat 6 - UTP - 1 Module	■	20
5723 54	White with orange shutter	■	10
5728 54	Magnesium with orange shutter	■	10
5723 55	White with green shutter	■	10
5728 55	Magnesium with green shutter	■	10



5736 28

UTP - 2 modules

5734 74	Information Socket - RJ45 - Cat 6 - UTP - 2 Module	■	10
5736 74	Information Socket - RJ45 - Cat 6 - UTP - 2 Module	■	10

UTP - 2 modules - round

5723 24	Information Socket - RJ45 - Cat 6 - UTP - 2 Module	■	10
5728 24	Information Socket - RJ45 - Cat 6 - UTP - 2 Module	■	10



5728 24

UTP with controlled access - 2 modules

Supplied with 2 keys for 5 sockets

5723 53	White with red shutter	■	5
5728 53	Magnesium with red shutter	■	5

UTP retractable RJ 45 sockets - 4 modules

With integrated retractable cord (0.9 m)
Winds up automatically with a pushbutton

5723 39	White	■	1
5728 39	Magnesium	■	1

FTP - 1 module

5723 22	White	■	10
5728 22	Magnesium	■	10

Shielded STP - 1 module

5734 34	White	■	10
5736 34	Magnesium	■	10

Bold Cat.Nos are products normally available with Legrand (India) Stockists. Cat.Nos that are not bold - delivery within 4 - 8 weeks from the date of order. Bold packing quantity is our mandatory packing. Orders to be placed by Legrand (India) Stockist in multiples of the same.

Legrand Cabling System LCS³

Category 6

Cat.Nos	Description	MRP* ₹ / Unit	Pack
---------	-------------	------------------	------

Myrius RJ 45 Sockets Cat. 6

UTP - 1 module

6730 55	Information Socket - RJ45 - Cat 6 - UTP - 1 Module	■	20
6731 55	Information Socket - RJ45 - Cat 6 - UTP - 1 Module	■	20

UTP - 2 modules

6730 56	Information Socket - RJ45 - Cat 6 - UTP - 2 Module	■	20
6731 56	Information Socket - RJ45 - Cat 6 - UTP - 2 Module	■	20

Soliroc RJ 45 Sockets Cat. 6 - IK 10

0778 91	IP 20 For at-risk areas or areas with no surveillance FTP socket	■	10
---------	---	---	----

Plexo RJ 45 Sockets Cat. 6 - IP 55 Closed Flap IK 07

Protection against water, dust. For industrial sites

0695 69	FTP socket Grey/white	■	5/100
0695 61	UTP socket Grey/white	■	1/20

Plexo 66 RJ 45 Socket Cat. 6 - IP 66 - IK 08

FTP socket

0904 67	9 contacts Weatherproofing ensured (IP 66) with plug inserted Inclined 90° Grey RAL 7016/T029	■	1
---------	---	---	---

Keystone RJ 45 Sockets Cat. 6

0765 88	Cat 6 UTP socket with fast connection thanks to integrated crimping	■	10
---------	---	---	----

Surface Mounting Box

1 or 2 ports

6327 79	For keystone connectors Provides solution for integration of keystone in surface mounting installations	■	20
---------	---	---	----

Legrand Cabling System LCS³

Category 5e

Cables for Cat 6 LANs 24 AWG

U/UTP - 4 Pairs

6327 24	Length 305 m Supplied in cardboard box Weight 16 kg. Dark grey RAL 7037	■	305
6327 24W	Length 305 m Supplied in cardboard box Weight 16 kg. White RAL 9003. MOQ - 50 box	■	305
6327 24O	Length 305 m Supplied in cardboard box Weight 16 kg. Orange RAL 2008 MOQ 50 Box	■	305
6327 24G	Length 305 m Supplied in cardboard box Weight 16 kg. Green RAL 6018 / 6024 MOQ 50 Box	■	305

* MRP - Maximum Retail Price Inclusive of all taxes including GST.

■ Price available on request.

Legrand Cabling System LCS³

Category 5e

Cat.Nos	Description	MRP* ₹ / Unit	Pack
---------	-------------	------------------	------

Cat. 5e Patch Panels Equipped with 24 RJ 45 Connectors

Flat panel with empty cassettes to be equipped with connectors

24 RJ 45 connectors - 1 U

0337 50	UTP	■	1
0337 51	FTP	■	1

Flat 24-Connector Patch Panels - 1 U to be Equipped

Flat panel with empty cassettes to be equipped with connectors

Equipped with 4 automatic extraction cassettes for cat. 5e to cat. 8 RJ 45 connectors

0337 90	19" panel - 1 U	■	1
---------	-----------------	---	---

Empty flat panel to be equipped with cassettes

It can accept a maximum of 4 automatic extraction cassettes:
- copper
- fibre optic

0337 91	19" panel - 1 U	■	1
---------	-----------------	---	---

Flat High Density 48-Connector Patch Panel - 1 U to be Equipped

0337 93	19" panel - 1 U	■	1
---------	-----------------	---	---

Angled 24-Connector Patch Panel - 1 U

Angled panel to be equipped with connectors

It can accept up to 24 cat. 5e to cat. 8 RJ 45 connectors

0337 92	19" panel - 1 U	■	1
---------	-----------------	---	---

Angled High Density 48-Connector Patch Panel - 1 U to be Equipped

0337 94	19" panel - 1 U	■	1
---------	-----------------	---	---

Cat. 5e High Density RJ 45 Connectors

0337 53	UTP	■	1
0337 54	FTP	■	1

Common Accessories for Flat and Angled Panels

Port blanking modules

0337 56	Divisible 6 port blanking plate for sealing from 1 to 6 ports	■	10
---------	---	---	----

Cord management

0337 59	For use with new generation Quick-Fix They provide side cord management	■	1
---------	---	---	---

Bold Cat.Nos are products normally available with Legrand (India) Stockists. Cat.Nos that are not bold - delivery within 4 - 8 weeks from the date of order. Bold packing quantity is our mandatory packing. Orders to be placed by Legrand (India) Stockist in multiples of the same.

Legrand Cabling System LCS³ Category 5e

Cat.Nos	Description	MRP* ₹ / Unit	Pack
---------	-------------	------------------	------

Specific Accessories for Flat Panels

0337 55	Cassette for flat panels to be equipped	■	1
0337 95	High density cassette for flat panels to be equipped	■	1
0337 57	Blanking cassette Used to blank the panel	■	1

Specific Accessories for Angled Panels

Angled panel cover

0337 58	For optimised management of the air flow inside the cabinet	■	1
---------	---	---	---

Cables for Local Networks Cat. 5e

LSZH - F/UTP - 4 pairs

0327 52	Length 305 m Supplied in cardboard box. Weight 12 kg	■	305 ¹
0328 50	Length 500 m Supplied on reel. Weight 21 kg	■	500 ¹

PVC - F/UTP - 4 pairs

0327 53	Length 305 m Supplied by box. Weight 11 kg	■	305 ¹
---------	---	---	------------------

RJ 45 Patch Cords & User Cords Cat. 5e

RJ 45 - RJ 45 right

PVC - U/UTP unscreened impedance 100 Ω

Grey

0518 17	Length 0.5 m	■	1
0516 36	Length 1 m	■	1
0516 37	Length 2 m	■	1
0516 38	Length 3 m	■	1
0516 39	Length 5 m	■	1

F/UTP screened impedance 100 Ω

Grey

0518 14	Length 0.5 m	■	1
0516 40	Length 1 m	■	1
0516 41	Length 2 m	■	1
0516 42	Length 3 m	■	1
0516 43	Length 5 m	■	1

Myrius RJ 45 Sockets Cat. 5e

UTP - 1 module

6730 54	Information Socket - RJ45 - Cat 5E - UTP - Toolless Systems - 1 Module	■	20
6731 54	Information Socket - RJ45 - Cat 5E - 1 Module	■	20

Mylic RJ 45 Sockets cat. 5e

UTP - 1 module

6755 47	White	■	20
---------	-------	---	----

* MRP - Maximum Retail Price Inclusive of all taxes including GST.
■ Price available on request.

Legrand Cabling System LCS³ Category 5e

Cat.Nos	Description	MRP* ₹ / Unit	Pack
---------	-------------	------------------	------

Arteor RJ 45 Socket Cat. 5e

UTP - 2 modules

5734 75	Information Socket - RJ45 - Cat 5E - UTP - 2 Module	■	10
5736 75	Magnesium	■	20

Plexo RJ 45 Sockets, Cat. 5e - IP 55 Closed Flap IK 07

Protection against water, dust
For industrial sites

0695 57	FTP socket Grey/White	■	1/20
0695 56	UTP socket Grey/White	■	1/20

Keystone RJ 45 Sockets Cat. 5e

0765 87	Cat 5e UTP socket with fast connection thanks to integrated crimping	■	10
---------	--	---	----

Surface Mounting Box

1 or 2 ports

6327 79	For keystone connectors Provides solution for integration of keystone in surface mounting installations	■	20
---------	--	---	----

Legrand Cabling System LCS³ Doubler Sockets, Adaptors & Accessories

Mobile Doublers

Clip into RJ 45 sockets to double applications

0327 83	TV/computer network or telephone double connector	■	10
0327 47	Telephone/telephone doubler	■	10
0327 45	Computer network/telephone doubler	■	10
0327 46	L1/L2 telephone doubler	■	10
0327 48	Computer network/computer network double connector	■	10

Weatherproof Adaptors

IP 55 - IK 07 - Allow all functions to be adapted
2 Mosaic modules IP 55 operation

Grey/White

0919 45	Locking tool (used for changing vandal-proof screws)	■	1
---------	--	---	---

Bold Cat.Nos are products normally available with Legrand (India) Stockists. Cat.Nos that are not bold - delivery within 4 - 8 weeks from the date of order. Bold packing quantity is our mandatory packing. Orders to be placed by Legrand (India) Stockist in multiples of the same.

Legrand Cabling System LCS³ Doubler Sockets, Adaptors & Accessories

Cat.Nos	Description	MRP* ₹ / Unit	Pack
---------	-------------	------------------	------

Soliroc adaptor

Used for adapting all functions 2 Mosaic modules
IK 10 - IP 55

0778 80	Adaptor with flap	■	1
0778 81	Adaptor without flap	■	1

Hypra adaptor

0539 49	IP 55 adaptor base	■	5
---------	--------------------	---	---

Cable protection accessories

Plastic material
IP 66/67 guaranteed connection with the pair
Cat.No 0 533 02
IP 55 with no connection for base with blank
Protection for RJ 45 shielded or unshielded cables ensuring a link of category 5
Conform to standards of the IEC 60603-7 series and to standard IEC 61076-3-106 (version 5)
Compatible with products on the market conforming to the standards listed

Plug

0533 00	Integrated PE with sealing ring and clamping blades Tool-free assembly Ability to protect cables of category 5e	■	3
---------	---	---	---

Flush-mounting base

0533 01	Locking base Supplied with RJ 45 female/female coupler cat. 5e	■	3
---------	--	---	---

Kit

0533 02	Flush-mounting base + plug	■	3
---------	----------------------------	---	---

RJ plugs for round cables

Gold-coated contacts 1.2 μm

RJ 11

0517 01	4 contacts, width 9.65 mm	■	50
---------	---------------------------	---	----

RJ 12

0517 02	6 contacts, width 9.65 mm	■	50
---------	---------------------------	---	----

RJ 45 cat. 5e

0517 03	8 contacts, width 11.70 mm	■	50
0517 04	9 contacts, width 11.70 mm	■	50

RJ 45 sleeves

0517 06	Black	■	50
0517 07	White	■	50

* MRP - Maximum Retail Price Inclusive of all taxes including GST.
■ Price available on request.

Legrand Cabling System LCS³ Doubler Sockets, Adaptors & Accessories

Cat.Nos	Description	MRP* ₹ / Unit	Pack
---------	-------------	------------------	------

Stripping tool

Slits the sheath and releases the conductors by rotation

For twisted pair cables

Does not damage the conductors

Stripper

0332 62	For twisted pair and fibre optic cable	■	1
---------	--	---	---

Crimping tool for RJ 45 plugs

Used for crimping plugs

RJ 4/6/8/9 contacts

Ratchet control of crimping

mechanism Able to cut and strip cables

0517 09	Tool with 3 crimping points High resistance steel material	■	1
---------	--	---	---

Legrand Cabling System LCS³ Data & Telephone Sockets, Patch Panels, Cable

Telephone sockets

RJ 11 and RJ 12 sockets

Equipped with a modular Jack connector with 1/4 turn terminal for fast connection Tap-off possible

5723 00	White - RJ 11, 4 contacts 1 module	■	10
5728 00	Magnesium - RJ 11, 4 contacts - 1 module	■	10
5723 13	White - RJ 11, 4 contacts - 2 modules	■	10
5728 13	Magnesium - RJ 11, 4 contacts - 2 modules	■	10

Audio/video system

Single master - 2 modules

With IDC connection

Conform to British Telecom

5723 10	White	■	10
5728 10	Magnesium	■	10

Single secondary - 1 module

With IDC connection

Conform to British Telecom

5723 01	White	■	5
5728 01	Magnesium	■	5

Bold Cat.Nos are products normally available with Legrand (India) Stockists. Cat.Nos that are not bold - delivery within 4 - 8 weeks from the date of order. Bold packing quantity is our mandatory packing. Orders to be placed by Legrand (India) Stockist in multiples of the same.



0539 49



0533 00



0533 01

Audio/Video System

Cat.Nos	Description	MRP* ₹ / Unit	Pack
---------	-------------	------------------	------

Patch Panel Telephone 50 ports 110 Connect

0335 79	19" panel - 1 U	■	1
---------	-----------------	---	---

Female HD15 Sockets

Used to transmit analogue video streams (VGA, XGA, UXGA depending on graphic card) between a source (computer) and a compatible receiver (video projector, TV, etc)

Arteor - Preterminated sockets - 1 module

Equipped with cord, length 15 cm

5720 97	White	■	1
5725 97	Magnesium	■	1

Arteor - Screw-type female HD15 sockets - 2 modules

5722 82	White	■	1
---------	-------	---	---

Arteor - Screw-type female HD15 sockets 2 modules + 3.5 mm Jack

5722 88	White	■	1
5727 88	Magnesium	■	1

HDMI Type A Sockets

Used to transmit high-definition digital audio/video streams between a source (computer, HD-DVD drive, etc) and a compatible receiver (TV, video projector, etc)

Arteor - Preterminated sockets HDMI 1.4 - 1 module

Equipped with cord, length 15 cm

5720 96	White	■	1
5725 96	Magnesium	■	1

Jack Sockets 3.5 mm

3.5 mm Jack connectors can be used to create audio/video links

Arteor - Preterminated sockets - 1 module

Equipped with cord, length 15 cm

5720 91	White	■	1
5725 91	Magnesium	■	1

Arteor - 4 screw-type female 3.5 mm Jack socket - 1 module

5722 74	White	■	1
5727 74	Magnesium	■	1

* MRP - Maximum Retail Price Inclusive of all taxes including GST.
■ Price available on request.



0335 79



5720 97



5720 96

Audio/Video System

Cat.Nos	Description	MRP* ₹ / Unit	Pack
---------	-------------	------------------	------

Arteor - Solder-type female 3.5 mm Jack socket - 1 module

5722 78	White	■	1
---------	-------	---	---

Display Port Sockets

Used to transmit high-definition digital audio/video streams between a source (laptop, computer, etc) and a compatible receiver (video projector, TV, etc)

Arteor - Preterminated socket - 1 module

Equipped with cord, length 15 cm

5720 90	White	■	1
5725 90	Magnesium	■	1

Arteor - Female 2 RCA Socket

Preterminated

Equipped with a 15 cm cord

5720 92	White	■	1
5725 92	Magnesium	■	1

Connection via screw terminals

5722 72	White	■	1
5727 72	Magnesium	■	1



5722 72

Arteor - Female 3 RCA Socket

Connection via screw terminals

5722 73	White	■	1
5727 73	Magnesium	■	1



5727 73

Other Audio & Video Sockets

Female BNC 75 socket - 1 module

5722 76	White	■	1
5727 76	Magnesium	■	1



5722 76

Arteor - Audio Sockets

XLR 3-pin - 2 modules

5722 83	White - Fast screw connection female	■	1
5727 83	Magnesium - Fast screw connection female	■	1
5722 77	White - Fast screw connection male	■	1



5722 83

Loudspeakers sockets

Terminal 4 mm²

5722 80	White - 2 modules	■	10
5727 80	Magnesium - 2 modules	■	10
5722 70	White - 1 module	■	10
5727 70	Magnesium - 1 module	■	10



5727 70

Bold Cat.Nos are products normally available with Legrand (India) Stockists. Cat.Nos that are not bold - delivery within 4 - 8 weeks from the date of order. Bold packing quantity is our mandatory packing. Orders to be placed by Legrand (India) Stockist in multiples of the same.

Audio/Video System

Audio/Video Patch Panels, Cords & Cables

Cat.Nos	Description	MRP* ₹ / Unit	Pack
---------	-------------	------------------	------

100 V Line Volume Attenuators - 2 modules

Used to adjust power and volume of a 100 V loudspeaker line

5722 84	White - 100 V - 25 W	■	1
5727 84	Magnesium - 100 V - 25 W	■	1

19" Patch Panels

0335 98	HD15 19" panel - 12 connectors	■	1
---------	--------------------------------	---	---

Cords

For connecting a socket to a terminal

HDMI 1.4 cord

0517 27*	Length 5 m	■	1
0517 20*	Length 10 m	■	1

Legrand Cabling System LCS³

Fibre Optic

Equipped 19" Optic Drawers

Sliding

0321 61	12 SC duplex multi-mode connectors for 24 fibres	■	1
0321 62	24 LC duplex multi-mode connectors for 48 fibres	■	1
0321 63	24 ST multi-mode connectors for 48 fibres	■	1
0321 64	12 SC duplex single-mode connectors for 24 fibres	■	1
0321 65	24 LC duplex single-mode connectors for 48 fibres	■	1
0321 66	12 SC APC duplex single-mode connectors for 24 fibres	■	1
0321 67	24 LC APC duplex single-mode connectors for 48 fibres	■	1

Rotating

0321 71	36 LC duplex multi-mode connectors for 72 fibres	■	1
0321 72	18 SC duplex multi-mode connectors for 36 fibres	■	1
0321 73	36 LC duplex single-mode connectors for 72 fibres	■	1
0321 74	18 SC duplex single-mode connectors for 36 fibres	■	1

19" Modular Optic Drawers

Sliding, equipped

0321 02	12 SC duplex multi-mode connectors for 24 fibres	■	1
0321 04	24 LC duplex multi-mode connectors for 48 fibres	■	1
0321 06	12 SC duplex single-mode connectors for 24 fibres	■	1

* MRP - Maximum Retail Price Inclusive of all taxes including GST.
■ Price available on request.

Legrand Cabling System LCS³

Fibre Optic

Cat.Nos	Description	MRP* ₹ / Unit	Pack
---------	-------------	------------------	------

Sliding, to be equipped with fibre optic blocks

It can accept all fibre optic blocks; 4 blocks maximum

0321 00	Empty drawer	■	1
---------	--------------	---	---

Fibre Optic Blocks

Singlemode fibre optic blocks (9/125 µm)

0321 17	ST block for 6 single-mode fibre optics	■	1
0321 10	SC duplex block for 6 single-mode fibre optics	■	1
0321 11	SC duplex high density block for 12 single-mode fibre optics	■	1
0321 12	SC APC duplex block for 6 single-mode fibre optics	■	1
0321 13	LC duplex block for 6 single-mode fibre optics	■	1
0321 14	LC duplex block for 12 single-mode fibre optics	■	1
0321 15	LC duplex high density block for 24 single-mode fibre optics	■	1
0321 16	LC APC duplex block for 12 single-mode fibre optics	■	1
0321 33	Single-mode 4 MTP ¹ feedthrough adapter	■	1

Multimode fibre optic blocks (62.5 and 50/125 µm)

0321 27	ST block for 6 multimode fibre optics	■	1
0321 20	SC duplex block for 6 multimode fibre optics	■	1
0321 21	SC duplex high density block for 12 multimode fibre optics	■	1
0321 23	LC duplex block for 6 multimode fibre optics	■	1
0321 24	LC duplex block for 12 multimode fibre optics	■	1
0321 25	LC duplex high density block for 24 multimode fibre optics	■	1
0321 34	Multimode 4 MTP ¹ feedthrough adapter	■	1

Bold Cat.Nos are products normally available with Legrand (India) Stockists. Cat.Nos that are not bold - delivery within 4 - 8 weeks from the date of order. Bold packing quantity is our mandatory packing. Orders to be placed by Legrand (India) Stockist in multiples of the same.

Legrand Cabling System LCS³ Fibre Optic

Cat.Nos	Description	MRP* ₹ / Unit	Pack
---------	-------------	------------------	------

Copper Block for Fibre Optic Drawer

0321 32	"It clips directly to the optic drawer to be equipped, Cat.No 0321 00 It gives the possibility of mixing fibre optic and copper"	■	1
---------	---	---	---

Accessories for Optic Drawer to be Equipped

Accessory for receipt of a fan-out

0321 28	It's clipped at the back of the drawer It enables the entry of preterminated Cat.Nos	■	1
---------	---	---	---

Blank

0321 29	Blank block	■	1
---------	-------------	---	---

Pigtail cassette

0321 30	Capacity 24 fibre optics	■	1
---------	--------------------------	---	---

Coiling kit

0321 31	1 accessory	■	1
---------	-------------	---	---

Optic Drawer Cassettes

Fibre optic splice cassette

0321 41	It can accept all modular fibre optic blocks	■	1
---------	--	---	---

Copper cassette to be equipped

0337 55	It can accept 6 cat. 5e, cat. 6 and cat. 6 _a connectors	■	1
---------	--	---	---

MTP¹ preterminated cassette (MPO compatible)

Front and rear extraction

High performance cassette, low insertion loss

<0.35 dB

0321 42	Multimode OM4 cassette (50/125 µm) 24 filaments LC OM4 Type A/C	■	1
0321 43	Multimode OM4 cassette (50/125 µm) 12 SC OM4 Type A/C	■	1
0321 44	Single-mode OS2 cassette (9/125 µm) type OS2 24 LC OS2 Type A/C	■	1
0321 45	Single-mode OS2 cassette (9/125 µm) 12 SC OS2 Type A/C	■	1

* MRP - Maximum Retail Price Inclusive of all taxes including GST.
■ Price available on request.

Legrand Cabling System LCS³ Fibre Optic

Cat.Nos	Description	MRP* ₹ / Unit	Pack
---------	-------------	------------------	------

Blanking cassette

0337 57	Used to blank the panel	■	1
---------	-------------------------	---	---

Adapters

0321 33	Single-mode 4 MTP ¹ adapter (installation in cassette 0 321 41)	■	1
0321 34	Multi-mode 4 MTP ¹ adapter (installation in cassette 0 321 41)	■	1

Accessories for 19" Panel to be Equipped with Cassettes

0321 46	Rear cable management accessory For installation on panels Cat.No 0 321 40	■	1
---------	---	---	---

Pigtails

50/125 µm - OM3 (PC)

Connectors

0322 20	SC 1 m LSZH	■	10
0322 21	LC 1 m LSZH	■	10
0322 22	ST 1 m LSZH	■	10
0322 23	SC 2 m LSZH	■	10
0322 24	LC 2 m LSZH	■	10

50/125 µm - OM4 (PC)

Connectors

0322 30	SC 1 m LSZH	■	10
0322 31	LC 1 m LSZH	■	10
0322 32	ST 1 m LSZH	■	10
0322 33	SC 2 m LSZH	■	10
0322 34	LC 2 m LSZH	■	10

Bold Cat.Nos are products normally available with Legrand (India) Stockists. Cat.Nos that are not bold - delivery within 4 - 8 weeks from the date of order. Bold packing quantity is our mandatory packing. Orders to be placed by Legrand (India) Stockist in multiples of the same.



0321 41

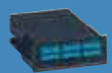

0321 43



0321 46



0322 20



0322 31

Legrand Cabling System LCS³

Fibre Optic

Cat.Nos	Description	MRP* ₹ / Unit	Pack
9/125 µm - OS2 (APC or UPC) - OS1 compatible			
Connectors			
0322 40	SC-APC OS2 1 m LSZH	■	10
0322 41	SC-UPC OS2 1 m LSZH	■	10
0322 42	LC-APC OS2 1 m LSZH	■	10
0322 43	LC-UPC OS2 1 m LSZH	■	10
0322 44	ST-UPC OS2 1 m LSZH	■	10
0322 45	SC-APC OS2 2 m LSZH	■	10
0322 46	SC-UPC OS2 2 m LSZH	■	10
0322 47	LC-UPC OS2 2 m LSZH	■	10
0322 48	LC-APC OS2 2 m LSZH	■	10

Set of 12 LC Pigtails

0326 24	OS2 12 pigtails LC-UPC	■	1
0326 26	OM3 12 pigtails LC-PC	■	1
0326 71	OM4 12 pigtails LC-PC	■	1

Pigtail Sleeves

0327 44	40 mm - bag of 50 sheaths	■	1
---------	---------------------------	---	---

Fan-Out Units

0330 48	6 fibre optic fan-out unit	■	1
0330 49	12 fibre optic fan-out unit	■	1

Precision Cleaver for the Update of the Case Kit Cat.No 0326 90

0322 80	It's used in conjunction with the kit of the case Cat.No 0 326 90, to cut the fibre optic with precision, and fit the quick-connect connectors, Cat.No 0 322 71 to 0 322 75	■	1
---------	---	---	---

High Density MTP1 Cassette (MPO compatible)

Fibre optic splice cassette

0321 41	It can accept all modular fibre optic blocks	■	1
---------	--	---	---

* MRP - Maximum Retail Price Inclusive of all taxes including GST.

■ Price available on request.

1: MTP is a registered trademark of US Conec Ltd

Legrand Cabling System LCS³

Fibre Optic

Cat.Nos	Description	MRP* ₹ / Unit	Pack
---------	-------------	------------------	------

Copper cassette to be equipped

0337 55	It can accept 6 cat. 5e, cat. 6 and cat. 6A connectors	■	1
---------	--	---	---

Multimode OM4 cassettes (50/125 µm)

0321 42	MTP ¹ cassette (MPO compatible) 24 LC OM4 Type A/C	■	1
0321 43	MTP ¹ cassette (MPO compatible) 12 SC OM4 Type A/C	■	1

Single-mode OS2 cassettes (9/125 µm)

OS2 type

0321 44	MTP ¹ cassette (MPO compatible) 24 LC OS2 Type A/C	■	1
0321 45	MTP ¹ cassette (MPO compatible) 12 SC OS2 Type A/C	■	1

Blanking cassette

0337 57	Used to blank the panel	■	1
---------	-------------------------	---	---

MTP¹ Adapters

It's installed in splice cassettes, Cat.No 0 321 41

It enables MTP¹/MTP¹ feedthrough

0321 33	Single-mode 4 MTP ¹ adapter	■	1
0321 34	Multimode 4 MTP ¹ adapter	■	1

Accessories for 19" Panel to be Equipped with Cassette

0321 46	Rear cable management accessory For installation on panels Cat.No 0 321 40	■	1
---------	--	---	---

Legrand Cabling System LCS³

Cables

Micro cables OM3 MTP1

0324 41	12 fibre optics - MTP ¹ -MTP ¹ Length 10 (m)	■	1
0324 42	12 fibre optics - MTP ¹ -MTP ¹ Length 20 (m)	■	1
0324 43	12 fibre optics - MTP ¹ -MTP ¹ Length 30 (m)	■	1
0324 44	12 fibre optics - MTP ¹ -MTP ¹ Length 40 (m)	■	1
0324 45	12 fibre optics - MTP ¹ -MTP ¹ Length 50 (m)	■	1



0324 41

Bold Cat.Nos are products normally available with Legrand (India) Stockists. Cat.Nos that are not bold - delivery within 4 - 8 weeks from the date of order. Bold packing quantity is our mandatory packing. Orders to be placed by Legrand (India) Stockist in multiples of the same.

Legrand Cabling System LCS³

Cables

Cat.Nos	Description	MRP* ₹ / Unit	Pack
---------	-------------	------------------	------

Micro Cables OS2 MTP1

0324 51	12 fibre optics - MTP ¹ -MTP ¹ Length 10 (m)	■	1
0324 52	12 fibre optics - MTP ¹ -MTP ¹ Length 20 (m)	■	1
0324 53	12 fibre optics - MTP ¹ -MTP ¹ Length 30 (m)	■	1
0324 54	12 fibre optics - MTP ¹ -MTP ¹ Length 40 (m)	■	1
0324 55	12 fibre optics - MTP ¹ -MTP ¹ Length 50 (m)	■	1

OM 4 Multimode Fibre Optic Cables (50/125 µm)

"Bend insensitive"

For multimode installations 50/125 µm, type OM 4

Aqua sheaths

Suitable for 10 Giga Ethernet networks

Loose Tube

0325 43	Indoor/outdoor (glass strands) 4 fibres - 2000 m	■	2000
0325 44	Indoor/outdoor (glass strands) 8 fibres - 2000 m	■	2000
0325 45	Indoor/outdoor (glass strands) 12 fibres - 2000 m	■	2000
0325 46	Outdoor, corrugated steel tape 4 fibres - 2000 m	■	2000
0325 47	Outdoor, corrugated steel tape 8 fibres - 2000 m	■	2000
0325 48	Outdoor, corrugated steel tape 12 fibres - 2000 m	■	2000

Tight Structure 900 µm

0326 65	Indoor/outdoor (glass strands) 6 fibres - 500 m	■	2000
0326 66	Indoor/outdoor (glass strands) 6 fibres - 1000 m	■	2000
0326 67	Indoor/outdoor (glass strands) 12 fibres - 1000 m	■	2000
0326 68	Indoor/outdoor (glass strands) 24 fibres - 1000 m	■	2000

OS 2 Single-Mode Fibre Optic Cables (9/125 µm) - (OS1 Compatible)

For single-mode installations 9/125 µm,

type OS 2

Yellow or black sheaths for outdoor,
rodent guard...

Loose tube

0325 02	Indoor/outdoor (glass strands) 4 fibres	■	2000
0325 03	Indoor/outdoor (glass strands) 8 fibres	■	2000
0325 23	Outdoor, corrugated steel tape 4 fibres	■	2000

* MRP - Maximum Retail Price Inclusive of all taxes including GST.

■ Price available on request.

Legrand Cabling System LCS³

Patch Cords

Cat.Nos	Description	MRP* ₹ / Unit	Pack
---------	-------------	------------------	------

Loose tube

0325 24	Outdoor, corrugated steel tape 8 fibres	■	2000
0325 25	Outdoor, corrugated steel tape 24 fibres	■	2000
0325 12	Indoor/outdoor (glass strands) 6 fibres	■	2000
0325 14	Indoor/outdoor (glass strands) 12 fibres	■	2000
0325 51	Indoor/outdoor (glass strands) 24 fibres	■	2000

Tight structure 900 µm

0325 50	Indoor/outdoor (glass strands) 12 fibres	■	2000
---------	---	---	------

OM 3 Multimode Fibre Optic Cables (50/125 µm)

"Bend insensitive"

For multimode installations 50/125 µm, type OM 3

Aqua sheaths

Suitable for 10 Giga Ethernet networks

Loose tube

0325 53	Indoor/outdoor (glass strands) 24 fibres	■	2000
0325 37	Indoor/outdoor (glass strands) 4 fibres	■	2000
0325 38	Indoor/outdoor (glass strands) 8 fibres	■	2000
0325 39	Indoor/outdoor (glass strands) 12 fibres	■	2000
0325 40	Outdoor, corrugated steel tape 8 fibres	■	2000
0325 41	Outdoor, corrugated steel tape 12 fibres	■	2000
0325 42	Outdoor, corrugated steel tape 24 fibres	■	2000

Tight structure 900 µm

0325 11	Indoor/outdoor (glass strands) 12 fibres	■	2000
0325 52	Indoor/outdoor (glass strands) 24 fibres	■	2000

Legrand cabling system LCS³

Patch Cords

OS 1/OS 2 (UPC) Single-Mode Optical Cords

SC/SC duplex cords

0326 00	Length: 1 m	■	3
0326 01	Length: 2 m	■	3
0326 02	Length: 3 m	■	3

Bold Cat.Nos are products normally available with Legrand (India) Stockists.
Cat.Nos that are not bold - delivery within 4 - 8 weeks from the date of order.
Bold packing quantity is our mandatory packing. Orders to be placed by
Legrand (India) Stockist in multiples of the same.



0326 66

Legrand Cabling System LCS³ Patch Cords

Cat.Nos	Description	MRP* ₹ / Unit	Pack
---------	-------------	------------------	------

SC/LC duplex cords

0326 03	Length: 1 m	■	3
0326 04	Length: 2 m	■	3
0326 05	Length: 3 m	■	3

LC/LC duplex cords

0326 28	Length: 0.5 m	■	3
0326 06	Length: 1 m	■	3
0326 07	Length: 2 m	■	3
0326 08	Length: 3 m	■	3
0326 29	Length: 5 m	■	3

LC/LC Uniboot duplex cords

Reversible polarity

0326 86	Length: 1 m	■	3
0326 87	Length: 2 m	■	3
0326 88	Length: 3 m	■	3
0326 89	Length: 5 m	■	3
0326 92	Length: 10 m	■	3

OM 4 Multimode Fibre Optic Cords (50/125 µm)

SC/SC duplex cords

0326 30	Length: 1 m	■	3
0326 31	Length: 2 m	■	3
0326 32	Length: 3 m	■	3

LC/LC duplex cords

0326 33	Length: 0.5 m	■	3
0326 34	Length: 1 m	■	3
0326 35	Length: 2 m	■	3
0326 36	Length: 3 m	■	3
0326 37	Length: 5 m	■	3

LC/LC Uniboot duplex cords

Reversible polarity

0326 95	Length: 1 m	■	3
0326 96	Length: 2 m	■	3
0326 97	Length: 3 m	■	3
0326 98	Length: 5 m	■	3
0326 99	Length: 10 m	■	3

* MRP - Maximum Retail Price Inclusive of all taxes including GST.
■ Price available on request.

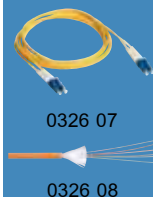

0326 07

0326 08

Legrand Cabling System LCS³ Patch Cords

Cat.Nos	Description	MRP* ₹ / Unit	Pack
---------	-------------	------------------	------

Legrand Cabling System LCS³ Fibre Optic Preterminated Solution

OM 3 Multimode Fibre Optic Cords (50/125 µm)

SC/SC duplex cords

0326 09	Length: 1 m	■	3
0326 10	Length: 2 m	■	3
0326 11	Length: 3 m	■	3

SC/LC duplex cords

0326 12	Length: 1 m	■	3
0326 13	Length: 2 m	■	3
0326 14	Length: 3 m	■	3

LC/LC duplex cords

0326 15	Length: 1 m	■	3
0326 16	Length: 2 m	■	3
0326 17	Length: 3 m	■	3



0326 13

Fibre Optic Feed through Sockets

2 x ST fibre optic feedthrough socket

Bayonet mount (STI compatible)

0786 16	White	■	1
---------	-------	---	---

2 x SC fibre optic feedthrough socket

"Push-pull" connection

0786 17	White	■	1
---------	-------	---	---

2 x LC fibre optic feedthrough socket

"Push-pull" connection

0786 18	White	■	1
---------	-------	---	---

Bold Cat.Nos are products normally available with Legrand (India) Stockists. Cat.Nos that are not bold - delivery within 4 - 8 weeks from the date of order. Bold packing quantity is our mandatory packing. Orders to be placed by Legrand (India) Stockist in multiples of the same.

KIT VIDEO DOOR PHONE

Standalone Video Door Phone Kit for Secure Entry Control



Standalone Video Door Phone Kit enhances residential security with a complete entry monitoring solution. Combining an indoor monitor and outdoor camera unit, it enables clear visual communication and controlled access for modern homes.

Features

- Outdoor video unit with wide-angle camera and night vision for visitor identification
- 7-inch indoor monitor with push-button or touch interface for call management
- Two-way audio and video communication with remote door unlock functionality
- Flexible configurations supporting single or dual indoor monitors for multiple entrances

Benefits

- Improves home security by allowing visual verification of visitors before entry
- Enhances convenience with real-time communication and door access control
- Supports flexible home setups with scalable indoor monitor configurations
- Provides reliable everyday protection through a simple and complete entry system

Scan to know more about the product.





KIT VIDEO

with memory

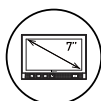

7" LCD screen with the resolution 1024*600



Built-in memory for 120 images

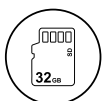

External SD card support



2MP Camera



120° camera angle



Colour night vision



Snap/video recording

Manage One Entrance

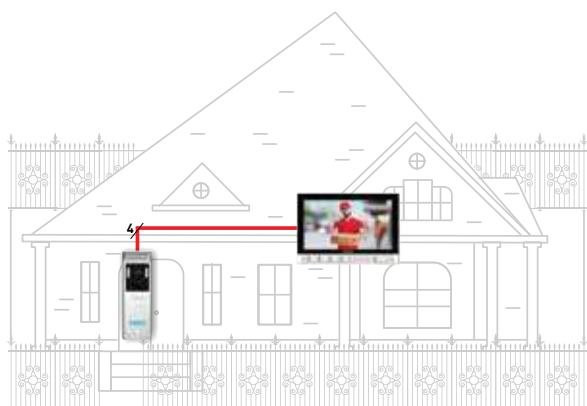

INSTALL 1 VIDEO KIT

Indoor Monitor 7" Push Buttons

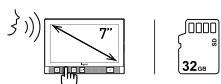

Built-in/Expandable memory

Manage Two Entrance

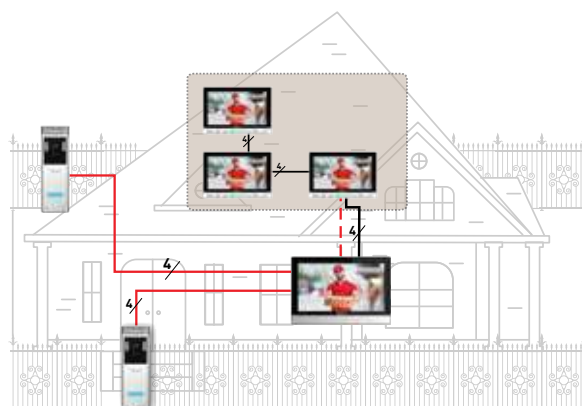

INSTALL 1 VIDEO KIT + 1 ADDITIONAL ENTRANCE PANEL + 3 ADDITIONAL INDOOR MONITORS

----- Add and mix up to 4 Indoor Monitors.

Indoor Monitor 7" Touch Buttons



Intercom



expandable kit

STANDALONE

Lighting Management Sensors

Standalone Sensors for Intelligent Lighting Control



Standalone Lighting Management Sensors provide a simple and energy-efficient solution for automated lighting control. Designed for offices, homes, and public spaces, they help reduce energy waste by automatically managing lighting based on occupancy and ambient conditions.

Features

- Occupancy, daylight, and combined sensors for automated lighting and HVAC control
- Compact and discreet designs that integrate seamlessly into modern interiors
- Reliable motion and light detection for accurate automation
- Adjustable sensitivity and delay settings for customized operation

Benefits

- Reduces energy consumption by automatically switching lights based on occupancy and daylight levels
- Simplifies installation with standalone plug-and-play functionality
- Supports sustainable buildings by improving energy efficiency
- Ensures dependable long-term operation with low maintenance requirements

Scan to know more about the product.



Movement Detectors

Cat.Nos	Description	MRP* ₹ / Unit	Pack
---------	-------------	------------------	------

Movement Detectors for Lighting Control

IP 20-IP 55 movement detector with 180- 360° detection angle. For 2000 Watt incandescent, 500 VA LED, 1000 VA fluorescent

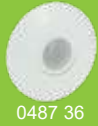

0487 36	Motion sensor PIR 360° Surface Mounting - 8m detection range - IP20 rated - Adjustable sensitivity and time delay	2746	1/20
0487 37	Motion sensor PIR 360° Recessed ceiling Mounting - 8m detection range - IP20 rated - Adjustable sensitivity and time delay	2466	1/36
0487 38	Microwave Motion sensor 360° - 8m range - IP20 - Recessed ceiling mounting - White	4114	1/36
0488 99	PIR 360° motion sensor Ø8m - IP20 - false ceiling mounting	6420	1/10
0488 06	Dual Tech - infra-red (PIR) and ultrasound (US) ceiling detector switch sensor 360°	13766	1/10
0488 07	PIR ceiling switch movement sensor 360° angle motion detector	14078	1/10
0488 17	PIR 360° Corridor sensor 2x12m - IP41 - ceiling mounting	15718	1/10
0488 04	PIR high density 360° lighting sensor Ø8m - IP42 - ceiling mounting	15994	1/10
0489 33	PIR 270° lighting sensor 18m - IP55 - surface wall or ceiling mounting	31394	1/10
0489 32	PIR 360° lighting sensor Ø20m high bay - IP55 - Surface ceiling mounting	26132	1/10
0489 53	Miniature PIR ceiling-mounting Lighting Management DALI dimming sensor for 1 circuit - 360°	21216	1/10
0489 54	Miniature PIR ceiling-mounting Lighting Management ON/OFF presence sensor for 1 circuit - 360°	18272	1/10
0489 59	PIR IP40/IP65 ceiling-mounting Lighting Management sensor for 1 circuit - 360° for high bay applications - ON/OFF	29290	1/10

* MRP - Maximum Retail Price Inclusive of all taxes including GST.
Red Cat.Nos - new products

Movement Detectors

Cat.Nos	Description	MRP* ₹ / Unit	Pack
---------	-------------	------------------	------

Movement Detectors for Lighting Control

0488 75	Surface-mounting box for false ceiling sensors	1104	1/10
0882 40	Smart Bluetooth configuration gateway for multi-application configuration tool	31532	1/10

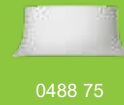

Video Door Entry Systems

Cat.Nos	Description	MRP* ₹ / Unit	Pack
---------	-------------	------------------	------

Door Entry Kits with Memory

3695 90	Door entry kit 7" physical buttons	15656	1/10
3695 91	Door entry kit 7" capacitive buttons	16158	1/10
3695 92	Indoor unit 7" physical buttons	10870	1/10
3695 93	Indoor unit 7" capacitive buttons	11550	1/10
3695 98	Entrance panel for door entry kit 7"	8230	1/20
3695 89	Power adapter for door phone kit	1092	1/50

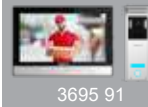

Bold Cat.Nos are products normally available with Legrand (India) Stockists. Cat.Nos that are not bold - delivery within 4 - 8 weeks from the date of order. Bold packing quantity is our mandatory packing. Orders to be placed by Legrand (India) Stockist in multiples of the same.



Video Door Entry System

IP System for the Best Performance

The ideal solution for large multiple-dwelling projects, able to guarantee high performance, long distances and high video signal quality.



Home + Security
The best App
for a safe home.



Scan to know more about
the product.



CLASSE 300EOS

The Smart Vision of the Home.

Classe 300EOS is the new 2 wires / Wi-Fi handsfree connected video internal unit with built-in Amazon Alexa voice assistant. Using the Home + Security App, in addition to video door entry calls, it is also possible to manage the devices of the Legrand connected security solutions, creating a simple and fast Smart security system.



Scan to know more about
the product.



P17

TEMPRA PRO

Industrial Plugs & Sockets

Weatherproof Power Connectivity for Harsh Environments

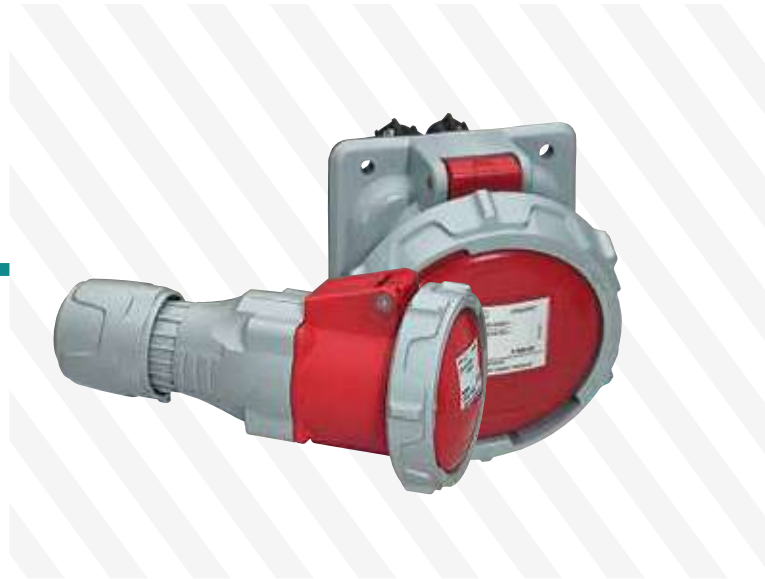

P17 Tempra Pro is a high-performance range of industrial plugs and sockets designed for demanding environments. With multiple weatherproof ratings and robust construction, the system ensures reliable power connectivity for environments such as airports, data centers, hotels, and outdoor installations.

Features

- 16–125A range with IP44 to IP69 protection
- Rugged, weatherproof & chemical-resistant build
- Quick & easy installation design
- Flexible mounting & multiple configurations
- Ergonomic design with safety compliance (IEC standards)

Benefits

- Works reliably in any environment (indoor/outdoor)
- Higher safety & secure connections
- Saves installation time & effort
- Low maintenance & long-lasting performance
- Adaptable for all project needs & applications



Range

IP44



Straight plugs



Mobile sockets



Panel mounting sockets



Surface mounting sockets

IP66/67/69*



Straight plugs

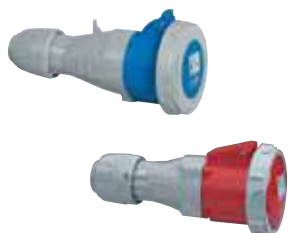

Mobile sockets



Panel mounting sockets



Surface mounting sockets



Scan to know more about the product.

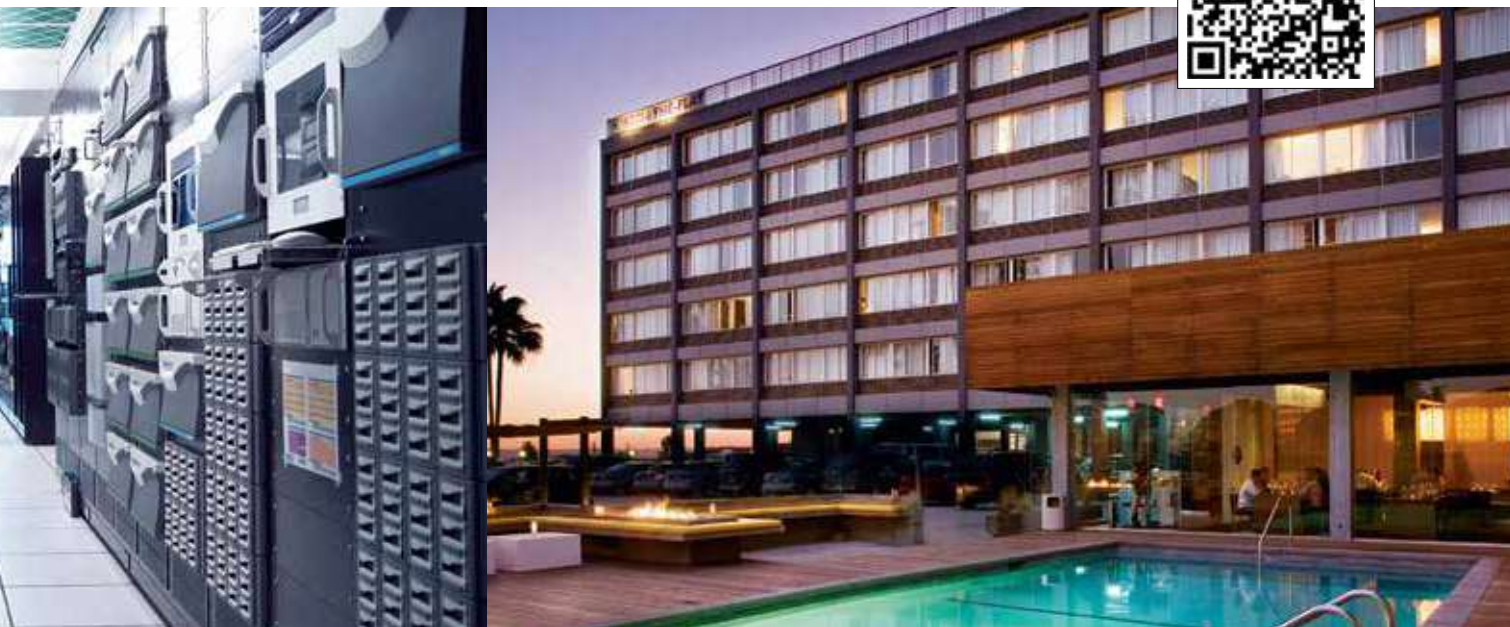

P17 Tempra Pro IP 44 - LV 16 & 32A - Sockets & Plugs

Cat.Nos	Description	MRP* ₹ / Unit	Pack
---------	-------------	------------------	------

Surface Mounting Sockets

5551 54	200/250 V~, 16 A 2P+E	971	10
5551 58	380/415 V~, 16 A 3P+E	1197	10
5551 59	380/415 V~, 16 A 3P+N+E	1268	10
5552 54	200/250 V~, 32 A 2P+E	1213	5
5552 58	380/415 V~, 32 A 3P+E	1518	10
5552 59	380/415 V~, 32 A 3P+N+E	1610	10



5552 58

Panel Mounting Sockets Inclined Outlet

5551 84	200/250 V~, 16 A 2P+E	602	10
5551 88	380/415 V~, 16 A 3P+E	885	10
5551 89	380/415 V~, 16 A 3P+N+E	933	10
5552 84	200/250 V~, 32 A 2P+E	926	10
5552 88	380/415 V~, 32 A 3P+E	1170	10
5552 89	380/415 V~, 32 A 3P+N+E	1240	10



5551 88

Mobile Sockets

5551 04	200/250 V~, 16 A 2P+E	784	10
5551 08	380/415 V~, 16 A 3P+E	873	10
5551 09	380/415 V~, 16 A 3P+N+E	926	10
5552 14	200/250 V~, 32 A 2P+E	1040	10
5552 18	380/415 V~, 32 A 3P+E	1249	10
5552 19	380/415 V~, 32 A 3P+N+E	1320	10



5551 08

Straight Plugs

5551 24	200/250 V~, 16 A 2P+E	556	10
5551 28	380/415 V~, 16 A 3P+E	682	10
5551 29	380/415 V~, 16 A 3P+N+E	716	10
5552 34	200/250 V~, 32 A 2P+E	837	10
5552 38	380/415 V~, 32 A 3P+E	955	10
5552 39	380/415 V~, 32 A 3P+N+E	1012	10



5551 28

P17 Tempra - Domestic Pin Configuration 16 A - 250 VA

Flush-Mounting Boxes

0577 21	For 2 panel mounting sockets With single fixing centres 70 x 70 mm - 16 A	5499	3
0577 22	For 1 panel mounting socket With single fixing centres 70 x 70 mm - 16 or 32 A (32 A to be fixed horizontally)	3300	3



0577 22

* MRP - Maximum Retail Price Inclusive of all taxes including GST.

P17 Tempra Pro IP 66/67 LV 16 and 32 A

Cat.Nos	Polarity	MRP* ₹ / Unit	Pack
---------	----------	------------------	------

Surface Mounting Sockets

5553 54	200/250 V~, 16 A 2P+E	1623	5
5553 58	380/415 V~, 16 A 3P+E	1806	5
5553 59	380/415 V~, 16 A 3P+N+E	1965	5
5554 54	200/250 V~, 32 A 2P+E	1924	5
5554 55	200/250 V~, 32 A 3P+E	3324	5
5554 59	380/415 V~, 32 A 3P+N+E	3602	5

Panel Mounting Sockets

5553 84	200/250 V~, 16 A 2P+E	1188	5
5553 88	380/415 V~, 16 A 3P+E	1263	5
5553 89	380/415 V~, 16 A 3P+N+E	1343	5
5554 84	200/250 V~, 32 A 2P+E	1507	5
5554 88	380/415 V~, 32 A 3P+E	1726	5
5554 89	380/415 V~, 32 A 3P+N+E	1833	5

Mobile Sockets

5553 04	200/250 V~, 16 A 2P+E	1452	5
5553 08	380/415 V~, 16 A 3P+E	1806	5
5553 09	380/415 V~, 16 A 3P+N+E	1917	5
5554 14	200/250 V~, 32 A 2P+E	1995	5
5554 18	380/415 V~, 32 A 3P+E	2132	5
5554 19	380/415 V~, 32 A 3P+N+E	2264	5

Straight Plugs

5553 24	200/250 V~, 16 A 2P+E	1263	5
5553 28	380/415 V~, 16 A 3P+E	1386	5
5553 29	380/415 V~, 16 A 3P+N+E	1473	5
5554 34	200/250 V~, 32 A 2P+E	1710	5
5554 38	380/415 V~, 32 A 3P+E	1797	5
5554 39	380/415 V~, 32 A 3P+N+E	1906	5



5553 28

P17 Tempra Pro IP 66/67 LV 32 A for Refrigerated Containers

Combined Unit, Plug & Mobile Socket for Refrigerated Containers

6571 06	Combined unit with interlocked switched socket - Double mechanical interlock - Cable glands are not supplied	25411	1
---------	--	-------	---



6571 06

Bold Cat.Nos are products normally available with Legrand (India) Stockists. Cat.Nos that are not bold - delivery within 4 - 8 weeks from the date of order. Bold packing quantity is our mandatory packing. Orders to be placed by Legrand (India) Stockist in multiples of the same.

P17 Tempra Pro IP 66/67 LV 32 A for refrigerated containers

Cat.Nos	Polarity	MRP* ₹ / Unit	Pack
---------	----------	------------------	------

Combined Unit, Plug & Mobile Socket for Refrigerated Containers

5554 41	Straight plug With cable grip Ø12 to 21.5 mm	2066	5
---------	--	------	---

P17 Tempra Pro IP 66/67 - LV 63 and 125 A

Surface Mounting Sockets

5555 54	200/250 V~, 63 A 2P+E	6710	2
5555 58	380/415 V~, 63 A 3P+E	7013	2
5555 59	380/415 V~, 63 A 3P+N+E	7410	2
5556 58	380/415 V~, 125 A 3P+E	19446	2
5556 59	380/415 V~, 125 A 3P+N+E	20611	2



5555 59

Panel Mounting Sockets

5555 84	200/250 V~, 63 A 2P+E	5324	2
5555 88	380/415 V~, 63 A 3P+E	5429	2
5555 89	380/415 V~, 63 A 3P+N+E	5718	2
5556 88	380/415 V~, 125 A 3P+E	15367	1
5556 89	380/415 V~, 125 A 3P+N+E	16432	1



5555 89

Straight Plugs

5555 24	200/250 V~, 63 A 2P+E	4508	2
5555 28	380/415 V~, 63 A 3P+E	4678	2
5555 29	380/415 V~, 63 A 3P+N+E	5021	2
5556 28	380/415 V~, 125 A 3P+E	13634	1
5556 29	380/415 V~, 125 A 3P+N+E	14448	1



5555 29

Mobile Sockets

5555 04	200/250 V~, 63 A 2P+E	5755	2
5555 08	380/415 V~, 63 A 3P+E	5974	2
5555 09	380/415 V~, 63 A 3P+N+E	6341	2
5556 08	380/415 V~, 125 A 3P+E	19845	1
5556 09	380/415 V~, 125 A 3P+N+E	21033	1



5555 09

Plugs & Sockets

Cat.Nos	Polarity	MRP* ₹ / Unit	Pack
---------	----------	------------------	------

P17 Combined Unit to be Equipped Bases with Mechanical Super-Compact Sockets

0573 00	16 A, 2P+E IP 44 Interlock	6719	1
0573 02	16 A, 3P+N+E IP 44 Interlock	7415	1
0573 20	16 A, 2P+E IP 55 Interlock	7537	1
0573 22	16 A, 3P+N+E IP 55 Interlock	8482	1
0577 23	Mounting plate for 2 super-compact mechanical interlock sockets	3774	1



0573 00

Bases for 125 x 220 mm face plates

Example of combined unit configuration

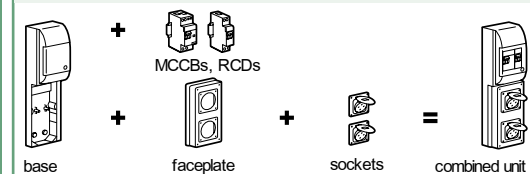

0577 10	Surface mounting box - upto 2 sockets	1571	2
0589 38	Surface mounting box with 5 module dinrail - upto 2 sockets	4391	1
0577 05	Surface mounting box with 12 module dinrail - upto 4 sockets	9702	1
0577 06	Surface mounting box with 18 module dinrail - upto 6 sockets	13580	1



0577 10



0577 05

Face Plates 125 x 220 mm without Sockets

0577 12	For 1 x 16 A or 32 - upto A socket	1489	5
0577 13	For 2 x 16 A - upto sockets	1871	5
0577 17	For 1 x 63 A - upto sockets	1718	5
0577 15	Blanking Plate	1263	5



Bases for 125 x 280 mm Face Plates

0577 11	Surface mounting box - upto 3 sockets	1636	3
0577 20	Surface mounting box with 5 module dinrail - upto 3 sockets	4712	1
0577 03	Surface mounting box with 12 module dinrail - upto 6 sockets	10057	1
0577 04	Surface mounting box with 18 module dinrail - upto 9 sockets	13989	1



0577 11



0577 04

* MRP - Maximum Retail Price Inclusive of all taxes including GST.

Bold Cat.Nos are products normally available with Legrand (India) Stockists. Cat.Nos that are not bold - delivery within 4 - 8 weeks from the date of order. Bold packing quantity is our mandatory packing. Orders to be placed by Legrand (India) Stockist in multiples of the same.

Plugs and Sockets

Cat.Nos	Polarity	MRP* ₹ / Unit	Pack
Face plates 125 x 280 mm without sockets			
0577 18	For 2 x 16 A and / or 32 A sockets	2339	4
0577 19	For 1 x 16 A or 32 A socket and 1 x 63 A socket	2199	2
0577 14	For 3 x 16 A sockets	2665	4
0577 16	Blanking plate	1485	4

Hypra Industrial Plugs & Sockets

Sockets

Prisinter Panel Mounting Sockets - IP 44, IK 09

0520 02	230 V, 16 A, 2P+E	13680	1/10
0527 02	230 V, 32 A, 2P+E	14916	1/6
0529 03	415 V, 32 A, 3P+E	15217	1/6
0529 04	415 V, 32 A, 3P+N+E	18078	1/6
0536 04	415 V, 63 A, 3P+N+E	58211	1

Panel Mounting Sockets - Inclined IP 44, IK 09

0522 23	415 V, 16 A, 3P+E	2213	5/50
0538 23	415 V, 63 A, 3P+E	7327	1

Plugs

Straight Plugs - IP 44, IK 09

0520 42	250 V, 16 A, 2P+E	2402	5/50
0527 42	250 V, 32 A, 2P+E	2965	1/5
0522 43	415 V, 16 A, 3P+E	3955	5/50
0529 43	415 V, 32 A, 3P+E	3969	5/50
0529 44	415 V, 32 A, 3P+N+E	4391	5/15
0538 43	415 V, 63 A, 3P+E	10484	1/5
0538 44	415 V, 63 A, 3P+N+E	14087	1/5

Metra Plugs & Sockets

Plugs

Ivory

6500 22	240 V, 10 A, 2P+E	260	1/5/100
6500 28	240 V, 20 A, 2P+E	273	1/5/100

Grey

6500 02	240 V, 10 A, 2P+E	260	1/5/100
6500 08	240 V, 20 A, 2P+E	273	1/5/100
6500 10	440 V, 20 A, 3P+E	364	1/5/100
6500 16	440 V, 32 A, 3P+E	685	1/5/100

Sockets

6500 03	240 V, 10 A, 2P+E With blue cap	264	1/5/100
6500 23	240 V, 10 A, 2P+E With ivory cap	264	1/5/100

* MRP - Maximum Retail Price Inclusive of all taxes including GST.

Hypra Industrial Plugs and Sockets

Cat.Nos	Description	MRP* ₹ / Unit	Pack
Sockets			
6500 09	240 V, 20 A, 2P+E With blue cap	303	1/5/100
6500 29	240 V, 20 A, 2P+E With ivory cap	303	1/5/100
6500 11	440 V, 20 A, 3P+E With red cap	407	1/5/100
6500 17	440 V, 32 A, 3P+E With red cap	685	1/5/100

Plugs and Sockets

P17 Tempra Combined Units

With Interlocked Switched Sockets & Surface Mounting Box IP 44

0566 01	250 V, 16 A, 2P+E	10091	1
0566 09	250 V, 32 A, 2P+E	12039	1
0566 13	415 V, 32 A, 3P+E	14559	1
0566 14	415 V, 32 A, 3P+N+E	15287	1

With Interlocked Switched Sockets and Surface Mounting Box IP 55

0566 21	250 V, 16A, 2P+E	11210	1
0566 29	250 V, 32 A, 2P+E	12805	1
0566 33	415 V, 32 A, 3P+E	16231	1
0566 34	415 V, 32 A, 3P+N+E	16527	1

With Interlocked Switched Sockets and Surface Mounting Box IP 44 with DIN Rail for 5 Module DX³ Protection

0566 41	250 V, 16A, 2P+E	10764	1
0566 49	250 V, 32 A, 2P+E	13094	1
0566 53	415 V, 32 A, 3P+E	14478	1
0566 54	415 V, 32 A, 3P+N+E	15492	1

With interlocked Switched Sockets & Surface Mounting Box IP 66 with DIN Rail for 5 Module DX³ Protection

0566 61	250 V, 16 A, 2P+E	12059	1
0566 69	250 V, 32 A, 2P+E	13992	1
0566 73	415 V, 32 A, 3P+E	15106	1
0566 74	415 V, 32 A, 3P+N+E	16331	1

With Interlocked Switched Sockets & Without Surface Mounting Box IP 55

0572 21	250 V, 16 A, 2P+E	9702	1
0572 29	250 V, 32 A, 2P+E	10970	1
0572 33	415 V, 32 A, 3P+E	13024	1
0572 34	415 V, 32 A, 3P+N+E	14227	1
0572 95	415 V, 63 A, 3P+N+E, IP 66	31046	1

P17 tempra Combined Units

with Interlocked Switched Sockets IP 66

0589 18	380 to 415 V, 50/60 Hz, 63 A, 3P + E with provision for 5 module DX ³ protection	33064	1
0572 99	380 to 415 V, 50/60 Hz, 63 A, 3P+N+E with provision for 5 module DX ³ protection	37256	1

Bold Cat.Nos are products normally available with Legrand (India) Stockists. Cat.Nos that are not bold - delivery within 4 - 8 weeks from the date of order. Bold packing quantity is our mandatory packing. Orders to be placed by Legrand (India) Stockist in multiples of the same.